

BC346XT

The Complete Reference

This document provides a complete reference to all menus, functions, and features of the BC346XT Handheld Trunk Tracker Scanner from Uniden. It is based on the Operation Specification that is used both as a guide to the software engineers for creating the scanner's user interface and as a repository for the "final say" on how every feature and function is implemented.

Some proprietary information has been removed, formatting has been modified, and extensive editing has been performed to make the text more readable. However, you will almost certainly find a handful of odd turns of phrases.

Mostly, though, we hope that this reference work can help you better understand and use your BC346XT. This document isn't intended to be a guide for how to use your scanner...you'll find that information in the Owner's Manual...but rather a reference for all the things that the scanner does. Combined with the Owner's Manual and the great resources available to scanner users online, you now have more information than ever on every facet of your scanner.

© 2009 Uniden Corporation
Fort Worth, TX
All Rights Reserved.

Contents

Feature Summary	8
Band Coverage	8
Channels	9
Memory Architecture	9
Channel Memory Scan	9
Priority Scan	9
Priority Plus Scan	9
Search with Scan	9
Scan Speed	9
Scanning Lockout	10
Temporary Lockout	10
Quick Keys	10
Startup Configuration	10
Channel Alert	10
Alpha Tagging	10
Duplicate Input Alert	10
Number Tag	10
Trunk Tracking	10
Multi-Site System	11
Control Channel Only	11
Priority ID Scanning	11
Preemptive Priority ID Scanning	11
Trunking Activity Indicators	11
Custom Search	11
Quick Search	11
Frequency Autostore	11
Search Speed / Turbo Search	11
Search Lockout	11
Search Key	12
Service Search	12
Broadcast Screen	12
Attenuator	12
Code Search	12
Volume Offset	12
IF Exchange	12
Dropout Delay	12

Weather and SAME Alert.....	12
Close Call [®] Frequency Capture	12
Close Call Temporary Store	13
Tone-Out Sequential Decode	13
Location-Based Scanning*	13
Location Alert System*.....	13
Navigation Modes*	13
GPS Compatibility*	13
Wired Cloning.....	13
Band Scope.....	13
PC Control.....	13
LCD and Keypad Backlight.....	13
Alert Tone Level	13
Battery Low Alert.....	14
Battery Save.....	14
Key Lock	14
Key Safe Mode.....	14
Repeater Reverse	14
Memory Backup	14
Design	15
Controls and Keys.....	16
Displays.....	21
LCD Design.....	21
Icons.....	21
Dot Matrix.....	22
LCD Flashing Time	22
Tones	23
General Tones	23
Weather Alert Sirens.....	23
Tones in Menu Mode	24
Selecting a menu item	24
Editing a name or a frequency etc.....	24
Alert in Scanner Mode	24
Alert in GPS Mode	24
Alert for Point Of Interest	24
Alert for Dangerous Xing.....	24
Alert for Dangerous Road	24

Battery Low Tone.....	24
Operation	25
Power On	25
Volume and Squelch Control	26
Volume Adjust Mode.....	26
Squelch Adjust Mode	26
Menu Mode	27
General Operations.....	27
Error Messages.....	30
Top Menu	31
Program System	31
Program Site	42
Program Group	51
Program Channel.....	55
Program Location.....	63
Srch/CloCall Opt	68
Search for.....	73
Close Call.....	82
Priority Scan.....	86
WX Operation.....	87
Tone-Out for	90
Wired Clone	94
Settings	95
SCAN MODE	101
Display during Scan Mode.....	101
Startup Key Operation	101
Start Scanning.....	101
Scanning Order	103
Scanning Operation	104
Temporary System Hold	115
System Hold.....	116
Quick System Select.....	116
Quick Save for CTCSS/DCS Data.....	117
Key Operation During Scan	118
SCAN HOLD MODE	120
Display while in Scan Hold Mode	120
General Operation.....	120

Hold on Conventional System	124
Hold on Trunked System	124
Hold on TalkGroup ID from ID Search / ID Scan.....	125
Direct Entry	125
Key Operation During Scan Hold Mode	128
PRIORITY SCAN.....	131
Priority Scan.....	131
Priority Plus Scan.....	132
Key Operation During Priority Scan.....	132
PRIORITY ID SCAN	133
Priority ID Scan	133
Key Operation During Priority ID Scan	133
SEARCH MODE	134
Display during Search Mode.....	134
General Operation.....	134
Service Search.....	135
Custom Search	136
Custom Search in Control Channel Only Mode.....	137
Search and Store	138
Quick Search.....	138
Key Operation During Search Mode.....	140
SEARCH HOLD MODE	142
General Operation.....	142
Go to Quick Search Hold Directly	142
Direct Entry	142
Quick Save	143
Key Operation During Search Hold Mode	144
CLOSE CALL MODE	146
Display during Close Call Mode.....	146
Close Call Search	146
Close Call Only	149
Close Call Hold	150
Close Call Auto Store.....	150
CC Hit with Scan.....	151
Direct Entry / Quick Save / Go to Quick Search Hold Mode	151
Key Operation During Close Call Only Mode	152
Key Operation During Close Call Hold Mode	153

WEATHER SCAN MODE	156
Normal Weather Scan.....	156
Weather Alert Scan.....	156
Weather (Alert) Scan Hold	157
Weather Alert Priority (WX Alt Priority)	158
Direct Entry / Quick Save.....	158
Key Operation During Weather (Alert) Scan Mode	158
Key Operation During Weather (Alert) Scan Hold Mode.....	159
TONE-OUT MODE	161
Display during Tone-Out Mode.....	161
Tone-Out Standby Mode.....	162
Tone-Out Search Mode	164
Tone-Out Hold Mode	165
Key Operation During Tone-Out Mode	166
GPS MODE.....	168
Display Mode in GPS Mode.....	168
Location Alert Operation	170
Registration of Location Information	173
Review Location Mode.....	174
Key Operation During GPS Mode.....	176
OBAND SCOPE MODE.....	178
Scope Mode	178
Search Mode.....	179
Max Hold Search Mode	179
Hold Mode.....	179
General Operation.....	180
Search Setting Parameters.....	181
Key Operation during Band Scope Mode	182
WIRED CLONE MODE	184
Confirm State	184
Transferring State	184
Complete State	184
Error State.....	185
Key Operation During Clone Mode.....	185
KEYLOCK	186
KEY SAFE MODE.....	187
Changed Key Operation in Key Safe Mode.....	187

Key Safe Operation.....	188
Key Safe Message	188
MEMORY INITIALIZATION	189
BATTERY CHARGE	190
Battery Type Select.....	190
Charging the Battery	190
OTHERS	193
AVAILABLE SYSTEM SETTINGS.....	193
System Settings	193
System Option Settings	193
Site Settings	194
Site Frequency Settings.....	194
Channel Settings.....	195
TGID FORMAT FOR TRUNKED SYSTEM.....	196
FLEET MAP	202
PRESET FLEET MAPS	203
WEATHER CHANNELS	204
CTCSS FREQUENCY	204
DCS CODE	204
CEA2009-SAME EVENT CODE(ANSI/CEA-2009-A October 2005).....	205
REMOTE COMMAND.....	207
CTCSS/DCS CODE LIST	254

Feature Summary

Band Coverage

Frequency (MHz)		Modulation	Step (kHz)	Remark
Lower Edge	Upper Edge			
25.0000	26.9600	AM	5.0	Petroleum Products & Broadcast Pickup
26.9650	27.4050	AM	5.0	CB Class D Channel
27.4100	27.9950	AM	5.0	Business & Forest Products
28.0000	29.6800	NFM	20.0	10 Meter Amateur Band
29.7000	49.9900	NFM	10.0	VHF Low Band
50.0000	53.9800	NFM	20.0	6 Meter Amateur Band
54.0000	71.9500	WFM	50.0	VHF TV Broadcast 2 – 4
72.0000	75.9950	FM	5.0	Intersystem & Astronomy
76.0000	87.9500	WFM	50.0	VHF TV Broadcast 5 – 6
88.0000	107.9000	FMB	100.0	FM Broadcast
108.0000	136.9916	AM	8.33	Aircraft Band
137.0000	143.9875	NFM	12.5	Military Land Mobile
144.0000	147.9950	NFM	5.0	2 Meter Amateur Band
148.0000	150.7875	NFM	12.5	Military Land Mobile
150.8000	161.9950	NFM	5.0	VHF High Band
162.0000	173.9875	NFM	12.5	Federal Government
174.0000	215.9500	WFM	50.0	TV Broadcast 7 – 13
216.0000	224.9800	NFM	20.0	1.25 Meter Amateur Band
400.0000	405.9875	NFM	12.5	Miscellaneous
406.0000	419.9875	NFM	12.5	Federal Government Land Mobile
420.0000	449.9875	NFM	12.5	70 cm Amateur Band
450.0000	469.9875	NFM	12.5	UHF Standard Band
470.0000	512.0000	NFM	12.5	UHF TV
806.0000	823.9875	NFM	12.5	Public Service Band
849.0125	868.9875	NFM	12.5	Public Service Band
894.0125	960.0000	NFM	12.5	Public Service Band
1240.0000	1300.0000	NFM	25.0	25 cm Amateur Band

Notes on Band Coverage:

- You can edit the Modulation and Step for each band. The above table shows the factory default values.
- Although TV bands are listed, the BC346XT cannot decode Digital TV audio.
- When you select “AUTO” for a channel or mode’s Modulation or Step, the above value is used (unless you’ve edited the Band Defaults).

Channels

Dynamic – You can create up to 9,000 total conventional channels, trunked channels, and trunked system frequencies.

- Channels in a conventional system contain a frequency.
- Channels in a trunked system contain a talk group ID (TGID).

Memory Architecture

Absolute Limits:

Systems	500
Sites Total	1,000
Sites/System	256
Channel Groups per System	20
Channels+System Frequencies	9,000
Channels per conventional system	1000
Channels per trunked system	500
Trunk Frequencies per Site	500-1000 (depending on total TGIDs stored in the system)

Notes about limits:

- The actual results will be limited by the first absolute limit you hit. For example, if you have created 1000 sites, you will not be able to create a new system even though you have created fewer than 500 systems.
- You can check the % of memory used by using the menu.

Channel Memory Scan

The scanner can scan any combination of trunked and conventional systems simultaneously.

Priority Scan

The scanner checks conventional priority channels every 1-10 seconds (2 seconds default) when scanning a conventional system.

Priority Plus Scan

The scanner scans only the conventional priority channels.

Search with Scan

The scanner can do Service and Custom Searches along with system scanning.

Scan Speed

100 Channels/Second (max) for conventional systems.

Scanning Lockout

You can lock out any System, Site, Channel Group, Channel, or search frequency.

Locked out channels are skipped (or ignored) during scanning.

If a system, site, or channel group is locked, all channels belonging to it will be skipped during scanning.

Temporary Lockout

Sites, Systems, Channels, or Frequencies temporarily locked out are automatically unlocked when power is cycled.

Quick Keys

You can assign an SQK (System/Site/Search Quick Key) from 0-99.

You can assign a GQK (channel Group Quick Key) from 0-9.

Quick keys can be rapidly enabled/disabled from the keypad during scanning.

Startup Configuration

You can assign a startup configuration key to a system or search range so that it can be automatically locked out or unlocked during power up.

Channel Alert

You can set a separate audible/visual alert for each channel.

Alpha Tagging

You can assign an alphanumeric name to each System, Site, Channel Group, Channel, Location, Custom search range, SAME group, and Tone-Out. You can use 16 characters per tag.

Duplicate Input Alert

The scanner will alert you if an entered alpha tag, frequency, etc has already been used in the same system.

Number Tag

You can assign a unique number tag from 0-999 to each system and to each channel within a system. This tag allows you to rapidly tune to a specific channel.

Trunk Tracking

The scanner can track the following types of trunked systems:

- Motorola Type I 800
- Motorola Type II 800, 900, UHF, VHF
- Motorola Rebanded
- EDACS Wide, Narrow, SCAT
- EDACS ESK (No ProVoice Decoding)
- LTR

Multi-Site System

All trunked systems can have more than one site. All sites in the system share the same Channel Groups and Channels.

Control Channel Only

Trunk Tracking can be achieved by entering only the control channels for Motorola systems.

Priority ID Scanning

Trunked channels can be assigned priority. When the scanner is monitoring the control channel, channels you tag as priority are given a higher priority over non-priority channels when they become active.

Preemptive Priority ID Scanning

For Motorola systems that have channel priority active on the system, if you flag a channel as priority and the system also has that TGID identified as a priority channel, the scanner will preempt any current transmission if the TGID becomes active.

Trunking Activity Indicators

The scanner shows all trunked activity when you hold on the control channel.

Custom Search

You can program up to 10 custom search ranges and either search them exclusively or include these searches when scanning.

Quick Search

If you hold on a conventional channel, you can start searching from the current frequency. If you hold on a trunked channel, you can quickly switch to ID Search mode.

Frequency Autostore

The scanner can automatically store frequencies found during a search.

Search Speed / Turbo Search

- 100 Steps/Second in search mode (max, except for 5 kHz steps)
- 300 Steps/Second in search mode (max, 5 kHz steps)
- Turbo mode automatically applies to 5 kHz step searches.

Search Lockout

You can lock out up to 500 frequencies.

- The limit of temporary L/O frequencies: 250
- The limit of permanent L/O frequencies: 250
- Locked out frequencies will be skipped in Search Mode or Close Call Mode.
- You can review all locked out frequencies in Menu Mode.

Search Key

Search keys are short cuts to start searching for a single search range.

There are 3 search keys (sr1 to sr3).

Service Search

You can search preset frequencies typically used by specific agencies or groups.

The kind of Service Search is as follows: Public Safety, News, HAM Radio, Marine, Railroad, Air, CB Radio, FRS/GMRS/MURS, Racing, FM Broadcast, Special

Broadcast Screen

Allows the scanner to ignore hits on Pager, FM, UHF TV, VHF TV, NOAA WX and custom band frequencies.

Attenuator

You can attenuate the incoming signal for channels that get interference from strong signal sources.

You can set a global attenuator to apply attenuation to all reception.

Code Search

Rapid search for the CTCSS/DCS used during a transmission.

Volume Offset

Adjust the volume level for any channel from -3 to +3 steps to balance audio level.

IF Exchange

Switches the current frequency to use a different IF (intermediate frequency) for receiving radio signals to avoid interference.

Dropout Delay

Controls whether the scanner pauses at the end of a transmission to wait for a reply.

You can set the Delay time for each System. All Channels in the System share the same delay setting. You can also set the Delay time for Search, Close Call and Tone-Out.

You can set the minus delay time. In that case, the scanner only stops on transmissions for the set duration, then automatically resumes.

Weather and SAME Alert

The scanner can alert to Weather Alert Tone, all FIPS or selected FIPS.

Close Call® Frequency Capture

The scanner can immediately detect and lock onto a transmission above threshold signal strength.

Close Call Temporary Store

The scanner scans the last 10 frequencies captured by Close Call so that you can continue to receive the signal even after the signal is not strong enough to trigger a Close Call hit..

Tone-Out Sequential Decode

Lets you set the scanner to act as a two-tone pager for fire tone-out standby. If you do not know the tones being used, the scanner can detect the tones when it receives a page.

Location-Based Scanning*

The scanner can automatically lock and unlock systems, sites and channel groups based on your current location as provided by an external GPS unit (not included).

Location Alert System*

The scanner alerts you when you approached a stored location.

Navigation Modes*

Indicate the Direction / Distance / Time to Goal for locations you set.

GPS Compatibility*

Compatible GPS units output location data that conforms to NMEA-0183 v3.01. The scanner uses the GGA and RMC sentences as defined by that specification. Note that this standard specifies an RS232 serial connection. GPS units that have USB connectivity are not compatible with this scanner.

Wired Cloning

You can clone all programmed data, including Memory Architecture, Menu settings and other parameters from one BC346XT to another BC346XT connected with RS232C cable.

Band Scope

Band Scope Mode searches a frequency range and displays a graphic of the signal level in real time.

In Band Scope Hold Mode, the user can monitor the frequency displayed.

PC Control

You can download information into the scanner and control the scanner via your personal computer.

LCD and Keypad Backlight

The Display Keypad backlight is orange.

The backlight can be adjusted to 3 different brightness levels

Alert Tone Level

This feature lets you adjust the volume level of the following tones: Key Beep, Emergency Alert, Channel Alert, Close Call Alert, Tone-Out detection Alert, Battery Low Alert and Location Alert.

Battery Low Alert

When the battery voltage becomes low, the  icon will blink and a Battery Low Tone will be generated every 15 seconds. This alert level is set at the same level as the key beep volume level.

Battery Save

You can turn on/off this function by Menu Operation.

This works when there is no transmission over 1 minute in the following modes. This feature turns off RF power for 1 second and turns on it 300 ms to extend the battery life.

- Scan Hold Mode at a Channel of conventional System (without Priority Scan)
- Any Search Hold Mode

Key Lock

This feature disables the keypad and scroll to prevent any accidental input.

Key Safe Mode

This mode helps keep novice users from accidentally changing parameters or modes.

Some keys don't work in this mode.

Repeater Reverse

One-touch key lets you switch to hearing the input frequency on a conventional repeater system or trunked system.

Memory Backup

Scanner memory is backed up semi permanently.

Design

The below is a design reference. There might be some differences between this image and the actual final design.



Controls and Keys

“Long press” means pressing a key more than 2 second.

Each key has a “normal” mode and a “Function” mode.

Normal Mode:

Normal Mode means that the scanner is not in Function Mode. In this mode, the **F** icon is not displayed.

Function Mode:

- Pressing [FUNC] puts the scanner into Function Mode for 3 seconds. While it is in Function Mode, the scanner displays the **F** icon. If you press a button, the Function Mode time is continued for another 3 seconds.
- Long pressing [FUNC] puts the scanner into Function Mode without a timeout. The scanner displays “Function Key” and “Holding”, and the **F** icon blinks.
- Pressing [FUNC] again in each Function Mode returns to Normal Mode and the **F** icon disappears.

Scroll Control

- Selects a channel or frequency in Hold Mode.
- Selects Menu items in Menu Mode.
- Selects a character while editing the Name.
- Sets the level in Volume / Squelch Level Control mode.

Scroll Control Push

- Pressing this works the same operation as pressing [E / yes / gps] in Menu Mode.
- Press this to set the volume level in the mode that is not Menu Mode.

Function + Scroll Control

- Use to select a System in Scan or Scan Hold Mode.

Function + Scroll Control Push

- Press this to set the squelch level in any mode other than Menu Mode.

Scan / srch (Search) Key

- Press to resume scanning. (Scan Hold Mode and while monitoring a channel in Scan Mode)
- Press to go to Scan Mode. (Except Scan Mode, Scan Hold Mode and GPS Mode)
- Press to return to the scanner screen. (GPS Mode)

Function + Scan / srch Key

- Press to resume searching. (Search Hold Mode and while monitoring in Search Mode)
- Press to toggle between ID SCAN and ID SEARCH while scanning a trunked system.
- Press to display the Quick Search Prompt. (Except in Search Mode, Search Hold Mode, GPS Mode and Band Scope Mode)
- Press to return to the scanner screen. (GPS Mode)
- Press to change the band scope search type. (Band Scope Mode)

Hold / (Close Call) Key

- Press to go to each Hold Mode. (Scan Mode, Search Mode, Close Call Only Mode, WX Scan Mode and Band Scope Mode)
- In Close Call Only Mode, the scanner sounds an Error Tone if it has not yet gotten a hit.
- Press to resume scanning or searching. (Hold Mode)
- Long press to go to the System Hold Mode (Scan Mode, Scan Hold Mode)

Function + Hold / Key

- Toggles the setting of Close Call.
- Long press to start Close Call Only Mode.

L/O (Lockout) Key

- Press once to temporarily lock out a system channel, a search frequency or a location data. This lock out is canceled when the power is turned off then back on.
- Press twice within one second to permanently lock out a system channel, a search frequency or a location data. This lockout remains even if the power is turned off.
- Long press to unlock all settings of the current system. (Scan Mode and Scan Hold Mode)
- All Locations of the current Type are unlocked by long-pressing this key. (Review Location Mode)
- The scanner unlocks all frequencies of Global Lockout List*. (Search Mode, Search Hold Mode, Close Call Only Mode and Close Call Hold Mode)
- Press to cancel a prompt without changing settings in Menu Mode.

*Global Lockout List means collecting the locked out frequencies at Search Mode, Search Hold Mode, Close Call Only Mode and Close Call Hold Mode.

Function + L/O Key

- Press once to temporarily lock out the current system, current site or current search range in Scan Mode and Scan Hold Mode. This lock out is cleared when power is turned off then back on.
- Press twice in a second to permanently lock out the current system or current search range in Scan Mode and Scan Hold Mode. This locked out is kept even if the power is turned off.
- Press to go to Rvw Search L/O. (Search Mode, Search Hold Mode, Close Call Only Mode and Close Call Hold Mode)
- Long press to display the prompt to unlock all systems, sites, search ranges and Close Call Hits system and enable all Quick Keys for systems/sites/search ranges. (Scan Mode and Scan Hold Mode) If you press [E / yes / gps], the scanner unlocks all data. If you press [. / no / pri], the scanner returns to the previous mode without unlocking.
- Long press to display the prompt for unlocking all Locations of all types. (Review Location Mode of GPS Mode) If you press [E / yes / gps], the scanner unlocks all data. If you press [. / no / pri], the scanner returns to the previous mode without unlocking.

(Light) / (Power) / (Key Lock)

- Press to illuminate the LCD back light according to Menu setting or to turn the backlight off if it is on.
- Press and hold to turn the scanner on or off.

Function + / / Key

- Press to lock or unlock the keypad.

1 - 9, 0 Key

- Press to enable or disable the System/Site/Search Quick Key for system or search range. (Scan Mode)
- Press to turn on or off each custom search range number. These keys operate only in Custom Search and not in other searches. (Search Mode)
- Press to go to Direct Entry Mode or to enter a Number Tag. (All Hold Mode, Close Call Mode and Tone-Out Mode)
- While editing a name, press [4 / LEFT] or [6 / RIGHT] to move the cursor to the left or right.

Function + 1 - 9, 0 Key

- Press to enable or disable Groups Quick Key in Scan Mode.

Function + 1 - 3 / sr1 - 3 (Search) Key

- Press [1 - 3 / sr1 - 3] to start Service Search, Custom Search, Tone-Out Mode or Band Scope Mode in Set Search Key. (except Scan Mode and GPS Mode)

Function + 4 / LEFT / ifx (IF Exchange) Key

- Press to exchange the IF (intermediate frequency) for receiving radio signals to avoid interference. (except Scan Mode and GPS Mode)

Function + 5 / |vl (Volume Offset) Key

- Press to change the volume offset level. (Scan Hold Mode)

Function + 6 / RIGHT / disp Key

- Press to change the Display Mode. (Scan Hold Mode and Custom Search Mode)
(Display mode 1 -> Display mode 2 -> Display mode 3 -> Display mode 1 ->....)
- Press to change the GPS Display. (GPS Mode)

Function + 7 / att (Attenuator) Key

- Press to toggle the attenuation state. (except GPS Mode)
- Long press to toggle global attenuator. (except GPS Mode)

Function + 8 / rev (Reverse) Key

- Press to monitor the current frequency's reverse frequency. It returns to current frequency when the key is released. (Scan Hold Mode, Search Mode, Search Hold Mode, Close Call Only Mode and Close Call Hold Mode)

Function + 9 / mod (Modulation) Key

- Press to change the modulation state. (except GPS Mode and WX Scan Mode)

Function + 0 / wx (Weather) Key

- Press to toggle WX Scan Mode and WX Alert Scan Mode while WX Scan or WX Alert Scan.
- Press to toggle WX Alert Priority. (except WX Scan Mode)
- Long press to start WX Scan. (except WX Scan Mode)

. (Decimal) / no / pri (Priority) Key

- Press to cancel these displays while displaying Error or Warning message.
- Press to input "."(decimal) for frequency.
- Press to input "-" or "i" for TGID.
- Press to input a space in editing a data name.
- Press twice to clear the data in editing data name.
- Press to input "-" or "i" for Direct Enter in Hold Mode, Close Call Only Mode, Tone-Out Mode.
- Press in Scan Mode to start the selection for the ten's place of a System/Site/Search Quick Key. Then, press number key to jump to each number's place of a Quick Key.

Function + . / no / pri Key

- Press to toggle Priority Mode in Scan Mode. (On / Plus On / Off)

E (Enter) / yes / gps Key

- Press to accept the input data or a Menu Item.
- Press to edit the channel data. (Scan Mode and Scan Hold Mode)
- Press to quickly save the frequency in Search Mode, Search Hold Mode, Close Call Mode, Close Call Hold Mode, WX Scan Mode and WX Scan Hold Mode.
- Press to go to the editing menu for current Tone-Out.
- Press to go to Review Location Mode. (GPS Mode)

Function + E / yes / gps Key

- Press to change GPS Mode.
- Long press to store a current location data.

Menu Key

- Press to enter the Menu Mode.
- Press to go back up one menu level when in the Menu Mode.
- Press after entering the value to indicate going to a number tagged system or channel.

Function + Menu Key

- Press to go to the editing menu for the current system, search range or location data.

Displays

LCD Design

The reference design shown below is for illustration purposes only and is not intended to be a photorealistic representation of the display.









Icons

- Sx: : This icon appears with icons of System and Site Quick Key numbers (from "0" to "99"). "x" shows the current ten's place of Quick Keys for Systems or Sites.
- GRP: This icon appears with icons of Quick Key number for Channel Groups (1 - 9, 0).
- 1 - 9, 0: In SCAN mode, the numbers of unlocked Quick Key for Systems/Channel Group are displayed. The number for the currently scanned SQK set flashes.

In SCAN HOLD mode, the Quick Key number for the current System/Channel Group appears.

Enabled User Range numbers appear in Custom Search; the current range's number blinks.
- HOLD: This icon appears in Scan Hold, Search Hold and Close Call Hold Mode.
- L/O: This icon appears at a locked out Channel or frequency.
- PRI: This icon turns on during Priority Scan and this blinks during Priority Plus.
- GPS: This icon appears when the scanner receives GPS data. This shows in the same place as " [GPS icon]".
- AM / FM / NFM / FMB / WFM: These icons show the modulation type.
- ATT: This icon appears when a channel has attenuator on and blinks when global attenuator is on.
- 067.0 / DCS023 etc.: The scanner displays the CTCSS/DCS here.

- SCR: This icon appears when one or more Broadcast Screen Band is set to on.
- WX: This icon turns on while the Weather Alert Priority Scan works.
-  (Function icon) : This icon appears in Function Mode. Function Mode does not have a timeout when this icon blinks.
-  (Priority Channel) : This icon appears when the channel set to "Priority On".
-  (Signal Indicator) : This icon shows strength of the signal from 0 to 5.
-  (KEYPAD LOCK): This icon will appear only when the KEYLOCK function is On.
-  (BATTERY Low Alert): This icon blinks when the battery voltage is low. This icon blinks when a bad battery is installed and an AC adapter is connected. This icon appears during battery check.
-  (Close Call Pri) : This icon appears in Close Call Priority Mode. This blinks in Close Call Only Mode or when the scanner gets a Close Call hit.
-  (Close Call DND) : This icon appears in Close Call DND Mode is CC DND Mode. This is a reverse display of Close Call Pri icon.

Dot Matrix

The display element consists of a 128 x 64 pixel display. See Font Data for character patterns.

Since the display is entirely dot matrix, a great variety of different things can be shown. The above shows the most common display elements in most modes. Additional examples are shown throughout this reference guide.

LCD Flashing Time

About 500 mS on/500 mS off (1 Hz).

Tones

The scanner can produce 3 fundamental tones, high (1200 Hz), middle (920 Hz), and low (640 Hz). Furthermore, there are Alert Tones and Weather Alert Sirens which include other sounds.

Additionally, special alert tones (Location Alert, CC alert, Emergency alert and WX alert, etc) can be set to custom volume levels.

General Tones

Key Touch Tone

When you press valid keys, the scanner will sound single high beep for 50 ms.

Confirmation Tone

The scanner will sound double high beep for confirmation (50 ms beep - 100 ms silent - 50 ms beep).

Exec Tone

When you press [E / yes / gps] key etc. to accept the entry or setting, the scanner will sound high-middle beep (75 ms high beep - 25 ms silent - 75 ms middle beep).

Error Tone

When you press a key that does not have a valid function in the current mode, the scanner will sound a triple low beep (75 ms beep - 25 ms silent -- repeat 2 times)

Weather Alert Sirens

The scanner sounds the following tones until any key is pressed, or for 8 seconds.

For Warning

[100 ms 120 Hz - (20 ms every 150 - 195 Hz in 5 Hz step) - (30 ms every 200 - 590 Hz in 10 Hz step) - 500 ms 600 Hz - 100 ms silent] --- repeat

For Watch

[(50 ms 800 Hz - 30 ms silent - 50 ms 1050 Hz - 30 ms silent) -- repeat 3 times - 170 ms silent] --- repeat

For Advisory

[100 ms 800 Hz - 50 ms silent - 100 ms 1050 Hz - 500 ms silent] -- repeat

For Weather Alert Tone: Same as Weather Alert Siren For Warning.

Tones in Menu Mode

Selecting a menu item

As you step to the next menu item by turning [Scroll Control] knob, the scanner will sound a single high beep for 100 ms.

However, if the menu item is the last item and you turn [Scroll Control] knob in the clockwise direction, the scanner will sound a double high beep (75 ms beep - 25 ms silent - 75 ms beep).

When you select a menu item by pressing [E / yes / gps] key, the scanner will sound a single middle beep for 100 ms.

Or, when you return to a previous menu by pressing [MENU] key, the scanner will sound a double middle beep (75 ms beep - 25 ms silent - 75 ms beep).

Editing a name or a frequency etc

When you select letters, the scanner sounds a single high beep for every click of the [Scroll Control] knob.

When you move the cursor from the left to the right, the scanner will sound a single middle beep (100 ms).

Or, when you move the cursor from the right to the left, the scanner will sound a double middle beep (75 ms beep - 25 ms silent - 75 ms beep).

If you store data by pressing [E / yes / gps], the scanner sounds the Exec Tone.

Alert in Scanner Mode

You can select channel or frequency alert from Alert1-9 in Menu by "Set Alert" and "Emergency Alert".

Each alert has a unique pattern of tones.

Alert in GPS Mode

Alert for Point Of Interest

You can select a location alert from Alert 1 to Alert 4 in Menu. Each alert provides a unique pattern of tones.

Alert for Dangerous Xing

The alert for Dangerous Xing is a fixed three-tone sequence.

Alert for Dangerous Road

The alert for Dangerous Road is a fixed five-tone sequence.

Battery Low Tone

At the low battery voltage level, the scanner will sound a single low beep (100 ms) every 15 seconds.

Operation

NOTE: Valid keys for the "Press Any Key" prompt are all keys except for [🔦 / 🔌 / 🔑]. Pressing [🔦 / 🔌 / 🔑] always turns on or off the backlight. And specially, pressing [L/O] cancels the prompt and exit from any Menu and so on immediately.

Power On

Press [🔦 / 🔌 / 🔑] for 1 second to turn on the scanner.

The scanner displays the opening screen and the copyright notice, and finally goes to the LAST MODE. The last select GPS Display mode is also backed up.

Notes on the Last Mode:

- LAST MODE means the mode when the scanner is turned off. It resumes Scan Mode, Custom/Service/Quick Search Mode, Weather Mode, Close Call Only, Tone-Out Mode, each Hold Mode, GPS Mode and Band Scope Mode for LAST MODE.
- In ID Search Hold Mode if ID has already been registered, LAST MODE will be ID Search Hold Mode. If ID has not been registered yet, LAST MODE will be Scan Mode.
- Review Location Mode is set to normal Scanner Mode (not GPS Mode).

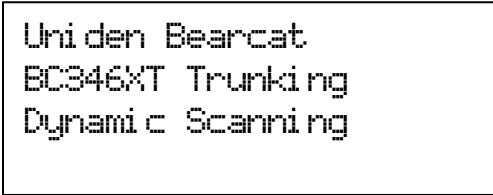

```
Uniden Bearcat
BC346XT Trunking
Dynamic Scanning
```

Opening Screen

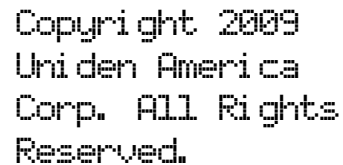

```
Copyright 2009
Uniden America
Corp. ALL Rights
Reserved.
```

Copyright Notice Screen

Volume and Squelch Control

Volume and Squelch can be adjusted by rotating the [Scroll Control] in the following modes: Scan Mode, Scan Hold Mode, Search Mode, Search Hold Mode, Tone-Out Mode, Weather Scan Mode, Close Call Only Mode, Band Scope Mode, Band Scope Hold Mode.

Volume Adjust Mode

To adjust the volume level, press [Scroll Control]. When the volume level indicator appears, rotate [Scroll Control] to change the volume level.

You can set the volume level from 0 to 15.

Press [Scroll Control] again or wait for 10 seconds to quit from the volume level control mode.

Squelch Adjust Mode

To adjust the squelch level, press [Function] + [Scroll Control]. When the squelch level indicator appears, rotate [Scroll Control] to change the squelch level.

The squelch level can set from 0 to 15.

Press [Scroll Control] key again or wait for 10 seconds to quit from the squelch level control mode.

Menu Mode

General Operations

Key Operation

To enter the Menu Mode: Press [Menu]

To select a Menu item: Turn [Scroll Control]

To select a Menu item or input data: Press [E / yes / gps] or tap the [Scroll Control]

To Return to the previous: Press [Menu]

To exit from Menu Mode:

- ➔ Press [Scan / srch] to go to Scan Mode
- ➔ Press [Hold / - ➔ Press [Menu] at Top Menu to return to previous mode
- ➔ Press [L/O] to exit Menu and return to previous mode

Notes:

- Tapping the [Scroll Control] can be used instead of [E / yes / gps] in Menu Mode or at various prompts.
- Next item is a lower item in this document. Therefore, the next item of the lowest Item is highest item.
- Menu items are described as the bold letter in this specification.

Display Format in Menu Mode

The Menu Item screen is four-line mode.

The first line displays the Menu Item Name and the selection items are displayed below.

For example, the Menu display of a channel modulation setting is as follows.



Select an item by turning [Scroll Control] until the item is highlighted, then pressing [E / yes / gps].

Edit Name

The editing cursor is displayed. Turn [Scroll Control] to choose the character and the cursor stays at the highlighted position.

Press [4 / LEFT / ifx] to move the cursor to the left and [6 / RIGHT / disp] to move it to the right.

Press [. / no / pri] once to erase one character with the cursor. Press it twice to erase all characters.

If the inputted name exists already in the same category, the scanner beeps Confirmation Tone and displays "Name Exists" and "Accept? (Y/N)".

By "Same category" we mean:

- A system name is the same as a service search range name, custom search range name or other system name.
- A group name is the same as another group name in the same system.
- A channel name is the same as another channel name in the same group.
- A custom search range name is the same as a system name, service search range name or other custom search range name.
- A SAME name is the same as another SAME name.
- A Tone-Out name is the same as another Tone-Out name.

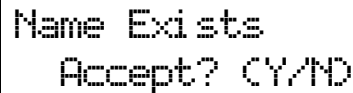

```
Name Exists
Accept? CY/ND
```

Press [E / yes / gps] to ignore the message and set the name. Then it proceeds to next step.

Press [. / no / pri] to return to the name editing state.

Note: If the user name has no character, the scanner prompts "Set Default Name" and "OK? (Y/N)".



```
Set Default Name
OK? CY/ND
```

Press [E / yes / gps] to set Name to the default name. Press [. / no / pri] to return to name editing.

Edit Frequency and Set Tone

The editing cursor is displayed.

Press a number key to enter each digit and press the decimal key to input a decimal point.

The cursor moves to the left or the right by turning [Scroll Control] knob.

If you press the decimal key when a decimal point is already entered, the frequency data is cleared and the editing cursor moves to the first position.

The stored frequency is determined by the following:

- The entered frequency is stored if it can be divided by a valid step.
- If it cannot be divided by a valid step, the scanner stores the nearer frequency at a frequency of 5kHz step or a frequency of 6.25kHz step. So, you must input the correct frequency to store a frequency of 7.5 kHz step or 8.33 kHz step. (See: Band Coverage)

If the frequency is out of the range in Band Coverage, the scanner displays "Out of Band", "Press Any Key" and sounds an Error Tone. Press any key to return to editing mode.

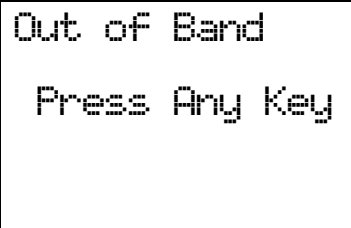

Out of Band
Press Any Key

For Channel Frequencies in conventional System, if the entered frequency is already stored into the same Group, it displays "Frequency Exists" "Accept? (Y/N)" and sounds a Confirmation Tone. Press [E / yes / gps] to ignore message and proceed to next step. Or press [. / no / pri] to return to the editing mode.

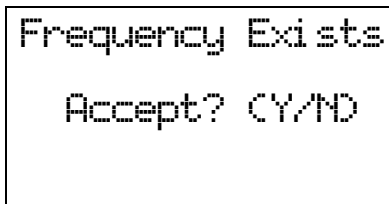

Frequency Exists
Accept? (Y/N)

Edit Talk Group ID

Decimal TGID edit

The editing cursor is displayed.

Press a number key to enter the TGID and press the decimal key to enter a hyphen. The cursor moves to the right by entering a number or hyphen.

Press the decimal key first to set "i" for I-Call entries. Then press the number keys to enter the I-Call ID.

Turn the [Scroll Control] to move the cursor position from left end to next to right end character, or from left end to right end character when you have already entered the maximum length.

Hexadecimal TGID edit

Turn the [Scroll Control] to select Hexadecimal characters from “0” to “F”,

Press [4 / LEFT / ifx] to move the cursor left or press [6 / RIGHT / disp] to move cursor right.

Press [E / yes / gps] to set the Hex ID.

Note: You can change the TGID format in *Set ID Format (DEC/HEX)*

If you press the decimal key when there are already an acceptable number of hyphens, the TGID is cleared and the editing cursor moves to the first position.

Note: For details of TGID formats, please see: *TGID FORMAT FOR TRUNKED SYSTEM.*

If the entered TGID is invalid, the scanner beeps an Error Tone and displays "Bad TGID".

Press any key to return to the editing mode.

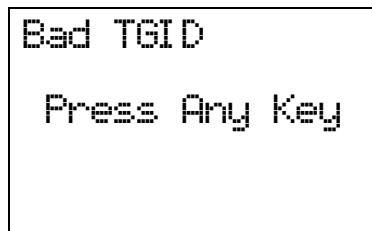

Notice of Location Data Input

Use WGS84 (World Geodetic System 1984) for latitude and longitude input.

The acceptable range of latitude and longitude is as follows.

- Latitude : 90°00'00.00 S - 00°00'00.00 N - 90°00'00.00 N
- Longitude : 180°00'00.00 E - 000°00'00.00 W - 180°00'00.00 W

The actual navigation distance may differ from the calculated one when a latitude exceeding 85 degrees (either North or South) is used.

Error Messages

If the scanner tries to create a new System/Location/Site/Group/Channel/TGID when it is already at the limit of System/Group/Channel, it displays “Over Limit”. (See: Memory Architecture)

If the scanner tries to create a new System/Location/Site/Group/Channel/TGID when the memory is full, it displays “Memory Full”.

If the scanner tries to create a new System/Location/Site/Group/Channel/TGID when the memory is broken, it displays “Memory Error”. When the scanner displays this message, you must initialize the memory by pressing [2 / sr2] + [9 / mod] + [Hold / 

Top Menu

Press [MENU] key to go to Menu Mode. Top Menu has the following items.

- Program System
- Program Location
- Srch/CloCall Opt
- Search for...
- Close Call
- Priority Scan
- WX Operation
- Tone-Out for ...
- Wired Clone
- Settings

Turn the [Scroll Control] to select items and press [E / yes / gps] to go to the selected item.

Press [Menu] to exit from Menu Mode.

Program System

You can select a System for editing or create a new System.

Names of existing Systems are displayed as Menu Items. These systems are sorted by the order in which they were created. "New System" is displayed as the last menu item.

Note: When no systems have been programmed, only "New System" appears.

The limit of Systems is 500. So, if you try to select "New System" when there are already 500 Systems, the scanner displays "Over Limit" and sounds an Error Tone. Then it returns to Top Menu.

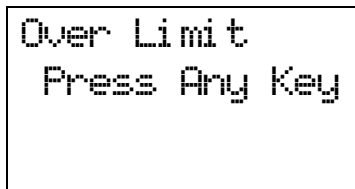

```
Over Limit
Press Any Key
```

Select the System Name and press [E / yes / gps] to go to the Systems Settings Menu. (See: System Settings)

If you select a protected system, "Protected System Access Not Allowed Press Any Key" is displayed and an Error Tone sounds.

Select "New System" and press [E / yes / gps] to create a new System.

Creating a New System

You can create up to 500 systems.

To create a new system, select the system type from the following items.

MOT Select for any Motorola Type system
EDCS Select for EDACS WIDE/NARROW or EDACS SCAT system
LT Select for an LTR system
Conventional Select for a non-trunked system.

If you select an EDACS type, you need to select more system type information from the following:

WIDE/NARROW Select for an EDACS WIDE/NARROW system
SCAT Select for an EDACS SCAT system

Once you select the system type, the scanner prompts "Confirm?" and "Yes="E" / No=".". "".

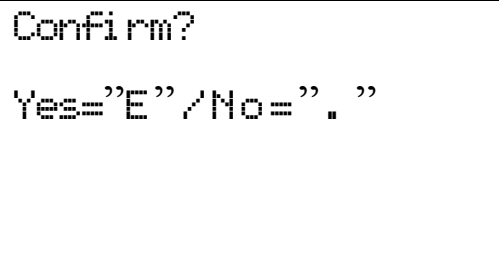

```
Confirm?  
Yes="E" / No="." . "
```

Press [E / yes / gps] to confirm, and the system will be created.

Press [. / no / pri] to reject and return to the Menu of Select System.

When the System is created, the scanner assigns a default System name of "System xxx T" to the new System. (xxx: 1-3 digits sequential number / T: initial of type; MOT="M", EDACS="E", LTR="L", Conventional="C"). Then, the scanner goes go to Edit System Menu.

Note: Once a system has been created, the system type setting cannot be changed.

System Settings

This menu has the following items.

- Edit Name
- Edit Sys Option
- Edit Site
- Edit Group
- Copy System
- Delete System

These setting items are different for each System Type. See [System Settings](#) for details of the differences.

The first line displays the System name. For example, the following figure shows it is in settings of the System named "System 1 C".

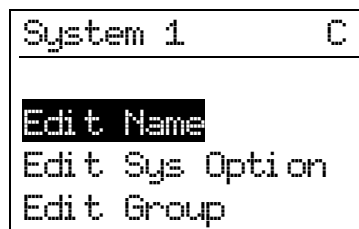

Turn the [Scroll Control] and press [E / yes / gps] or tap the [Scroll Control] to go to each setting.

Edit Name

You can name the system. Refer to [FONT DATA](#) for the characters that can be entered.

Press [E / yes / gps] to accept the name entered. The scanner returns to the previous menu.

Edit Sys Option

You can change the following System settings.

- Set Quick Key
- Set Startup Key
- Set Number Tag
- Set Lockout
- Set Hold Time
- ID Scan/Search
- Set Delay Time
- Edit Fleet Map
- Priority ID Scan
- Set Status Bit
- Set End Code
- Emergency Alert
- Set ID Format (DEC/HEX)
- Set ID Format (AFS/DEC)
- Rvw ID:Srch L/O
- Clr All L/O IDs

These setting items are different for each System Type. See *System Option* for details of the difference.

Press [E / yes / gps] to enter each setting.

Set Quick Key

This option allows you to select key that will rapidly lock/unlock the System when the scanner is Scan Mode. Turn the [Scroll Control] to select the Quick Key for the System. The Quick Key can be set from "0" to "99" and "." (= Not assigned).

Press a number key to jump the cursor to the head number of ten's place. For example if you press [2 / sr2], the cursor jumps to "20".

Press [E / yes / gps] to accept and return to the previous menu.

Note: The highest number of priority is Quick Key 1 and lowest number is Quick Key 90.

(See: *Scanning Order.*)

Set Startup Key

The scanner locks or unlocks the system according to setting of this option by pressing and holding a number key at power-on or while displaying the Opening Screen.

Turn [Scroll Control] to select the Startup Key in this menu. The Startup Key can be set from "0" to "9" and "." (= Not assigned).

Press [E / yes / gps] to accept the selection and return to the previous menu.

Set Number Tag

The System Number Tag can be set in this menu.

Press a number key to input the number tag. Press [. / no / pri] to clear the input.

Press [E / yes / gps] to accept the setting and return to the previous menu.

Note: The valid setting range is from 0 to 999. Blank means a number tag not assigned.

Set Lockout

This option allows you to lock or unlock the current system. When the system is locked out, the scanner does not check it.

Unlocked	The system is unlocked.
Temporary L/O	The system is temporarily locked out.
Lockout	The system is locked out.

Press [E / yes / gps] to accept the selection and return to the previous menu.

Set Hold Time

This setting determines the minimum time the scanner is forced to hold and scan System Channels before moving to the next System, even if there is no traffic on the Channels. You can set it from 0 to 255 seconds by pressing a number key.

Press [E / yes / gps] to accept the entry and return to the previous menu.

If you enter over "255" for the Hold Time, the scanner prompts "Out of Range" and "Set Max? (Y/N)". When [E / yes / gps] is pushed, maximum value 255 will be set.

It returns to the edit state, if you press [. / no / pri].

Note: The scanner will check all unlocked Channels at least 1 time before moving to the next system, independent of whether the hold time has been set or not.

ID Scan/Search

This setting determines how the scanner scans trunked Systems.

ID Scan	The scanner only stops on TGIDs that have been programmed and not locked out.
ID Search	The scanner stops on any TGID that is not locked out.

Press [E / yes / gps] to set the setting and return to the previous menu.

Set Delay Time

This setting controls how long the scanner stays on a transmission before resuming scanning. If you select a positive value, the scanner will hold on the channel for that duration after the carrier drops before resuming scanning. If you select a negative value, the scanner will stay on a transmission until the carrier drops or until the selected time elapses, whichever is shortest.

Turn [Scroll Control] to select the delay time setting from the following list:

- 10 sec
- 5 sec
- 2 sec
- 0 sec
- 1 sec
- 2 sec
- 5 sec
- 10 sec
- 30 sec

Then press [E / yes / gps] to accept and return to the previous menu.

Edit Fleet Map

Motorola 800 Type I/Hybrid Systems require a Fleet Map that sets specific Fleet - SubFleet parameters. There are 16 preset Fleet Maps listed in [PRESET FLEET MAP](#) that you can choose, and these are usually a good place to start when setting up a Type I/Hybrid System. If you choose a preset map and still have difficulty following complete conversation, then you will have to program a Custom Fleet Map.

Note: A Hybrid System is simply a Type I System with some blocks designated as Type II blocks. Select Size Code 0 to treat the block as Type II and select others to treat as Type I.

You can select from "Preset" and "Custom".

- Preset
- Custom

Preset

If "Preset" is selected by pressing [E / yes / gps], you need to select from 16 preset Fleet Maps.

- Preset 1
- Preset 2
- :
- Preset 16

Press [E / yes / gps] to select one of the 16 preset Fleet Maps and return to the previous menu.

Custom

On the other hand, if "Custom" is selected, then you are prompted to enter the Fleet Map information.

You need to set Size Codes to all Blocks in order.

There are 8 Blocks from "Block 0" to "Block 7" and 15 Size Codes from "Size Code 0" to "Size Code 14".

In this selection, first Line displays the Block number and after second lines displays the Size Code.

```
Size Code 0
Size Code 1
Size Code 2
  :
Size Code 14
```

Turn [Scroll Control] to select the Size Code. Press [E / yes / gps] to set the Size Code and proceed to the next Block setting. And press [Menu] to go back to the previous one.

Press [E / yes / gps] at the last Block to return to the previous menu with the current selection.

Press [Menu] at Block 0 to return to the previous menu. However, Size Codes once selected by pressing [E / yes / gps] are not canceled.

Motorola 800 Type I and Type II:

Select Custom and set all blocks to Size Code 0. The scanner treats this System as Motorola Type II. In other cases, it treats the System as Motorola Type I.

Note: If you change the Fleet Map setting, the ID display format will also change.

Priority ID Scan

This setting controls how the scanner treats Priority IDs.

You can select the following items.

On	The scanner scans all unlocked IDs and also checks Priority IDs.
Off	The scanner provides no special treatment for Priority IDs.

Press [E / yes / gps] to accept the selection and return to the previous menu.

Set Status Bit

This setting determines how the scanner treats the status bits.

Yes	The scanner pays attention to the status bits in the TGID.
Ignore	The scanner ignores status bits in the TGID.

Press [E / yes / gps] to accept the entry and return to the previous menu.

Set End Code

This setting determines how the scanner treats the transmission end code.

- Yes The scanner pays attention to the analog transmission end code.
- Ignore The scanner ignores the transmission end code and waits for carrier drop.

Press [E / yes / gps] to accept the selection and return to the previous menu.

Emergency Alert

The following options can be set in this menu.

- Set Alert Tone
- Set Alert Light

Press [E / yes / gps] to enter the setting.

Set Alert Tone

If "Set Alert Tone" is selected, user can determine how the scanner treats the Talk Group that set with emergency flag.

- Off The scanner ignores the emergency flag.
- Alert1-9 The scanner sounds the Emergency Alert Tone when any Talk Group goes active with the emergency flag set.

When you select "Off", the scanner returns to the previous menu.

When you select "Alert1-9", the scanner goes to the Alert Level selection.

- Auto The alert is set to the same volume as normal audio.
- Level1-15 The alert is fixed to the selected audio level.

Press [E / yes / gps] to accept the entry and return to the previous menu.

Set Alert Light

If "Set Alert Light" is selected, you can select from the following Alert Light Pattern selections.

- Off The alert light will not turn on
- On The alert light is set to on
- Slow Blink The alert light blinks slowly
- Fast Blink The alert light blinks fast

Press [E / yes / gps] to accept the entry and return to the previous menu.

Set ID Format (DEC/HEX)

You can select the format for TGIDs on MOT type system.

- Decimal Format The scanner uses decimal format for TGIDs.
- Hex Format The scanner uses hexadecimal format for TGIDs.

Press [E / yes / gps] to accept the entry and return to the previous menu.

Set ID Format (AFS/DEC)

You can select the format for TGIDs on EDACS WIDE/NARROW systems.

AFS Format The scanner uses AFS format for TGIDs.
Decimal Format The scanner uses decimal format for TGIDs.

Press [E / yes / gps] to accept the entry and return to the previous menu.

Rvw ID:Srch L/O

Allows you to review TGIDs that are locked out in ID Search or ID Scan. Any TalkGroup in this list will be skipped if encountered in ID Search or ID Scan.

This option displays "temporarily L/O IDs" and "permanently L/O IDs" without distinction.

The first Line displays "Unlock?(Y/N)" and other lines display TGIDs that are locked out. Turn the [Scroll Control] to choose TGIDs.



```
Unlock?(Y/N)
ID: 12340
ID: 11111
ID: 34567
```

Press [E / yes / gps] to unlock the TGID.
Press [. / no / pri] to advance to the next locked TGID.
Press [Menu] to return the previous menu.

If no TGIDs have been locked, the scanner displays "Nothing Locked". Press any key to return to the previous menu.

If all TGIDs are unlocked, it displays "Nothing Locked". Press any key to return to the previous menu.

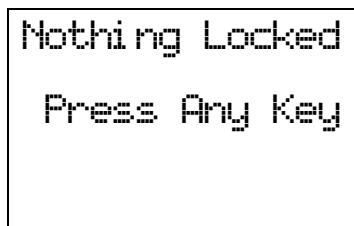

```
Nothing Locked
Press Any Key
```

Clr All L/O IDs

Selecting this causes the scanner to prompt "Confirm ?" and "Unlock All(Y/N)".

```
Confirm?  
Unlock ALL(Y/N)
```

Press [E / yes / gps] to unlock all TGIDs.

Press [. / no / pri] to cancel this selection.

The scanner returns to the previous menu.

If all TGIDs are unlocked, it displays "Nothing Locked". Then press any key to return to previous menu.

```
Nothing Locked  
Press Any Key
```

Edit Site

See *Program Site*.

Edit Group

See *Program Group*.

Copy System

You can copy the System and all associated settings by select this menu item. The scanner prompts you for a new System Name.

```
New Sys Name?  
_____  
  
4 ← cursor → 6
```

Press [E / yes / gps] to copy the System with the entered System name. The scanner goes to the *System Settings* menu with the new System active.

Note: This operation also copies all sites, Groups and Channels belonging to the System.

Delete System

You can delete the current system and all associated settings by select this menu item. The scanner prompts "Confirm Delete?" to confirm deletion.

Press [E / yes / gps] to delete the current system.

Press [. / no / pri] to cancel deletion and return to the previous menu.

Note: If you confirm to delete the system, all site, all Groups and all Channel data belonging to the System are also deleted.

Program Site

You can select an existing Site for editing or create a new Site. Site Names that already have been created are displayed as Menu Items.

Sites are sorted in the order of the Site Quick Key (See: [Set Quick Key](#)) as 1, 2,...,0,11,...99, 90 and not assigned. The order of Sites belonging to the same Quick Key is determined by the order in which they were created. "New Site" is displayed as the last menu item.

Select "New Site" and press [E / yes / gps] to create a new site.

Note: At first, only "New Site" is displayed.

The limit of Sites in a system is 256. So, if you try to select "New Site" when there are already 256 Sites, the scanner displays "Over Limit" and sounds an Error Tone.

Creating a New Site

Press [E / yes / gps] to create a new site. After a new site is created, the scanner assigns a default site name of "Site xxx-yyy TTT".

xxx: System index number,

yyy: 1-3 digit sequential site index number,

TTT: abbreviation for the site type, as follows.

MOT Type = "MOT"

EDACS WIDE/NARROW= "EDC"

LTR Type = "LTR"

Site Settings

The following site settings are possible:

- Edit Name
- Set Quick Key
- Set Startup Key
- Edit Band Plan
- Set Site Type
- Set Frequencies
- Set Modulation
- Set Attenuator
- Set Lockout
- Set Hold Time
- Set LocationInfo
- Delete Site
- New Site

The items available are different for each Site Type. See [Site Settings](#) for details of the difference.

Turn [Scroll Control] knob and press [E / yes / gps] key to go to each setting.

Edit Name

You can name the site.

Refer to FONT DATA for the characters that can be entered.

Press [E / yes / gps] to accept the name entered. The scanner returns to the previous menu.

Set Quick Key

This option lets you select which Quick Key will rapidly lock/unlock the site in Scan Mode.

Turn [Scroll Control] to select the Site Quick Key. The Site Quick Key can be from "0" to "99" and "." (= Not assigned).

Press a number key to jump the cursor to the head number of ten's place. For example if you press [2 / sr2], the cursor jumps to "20".

Press [E / yes / gps] to accept and return to the previous menu.

Set Startup Key

The scanner locks or unlocks the site according to setting of this option by pressing and holding a number key at power-on or while displaying the Opening Screen.

Turn [Scroll Control] to select the Startup Key in this menu. The Startup Key can be set from "0" to "9" and "." (= Not assigned).

Press [E / yes / gps] to accept the selection and return to the previous menu.

Edit Band Plan

This menu is shown when the selected system is a MOT type system.

You can select one of three kinds of band plans:

800/900 Standard

800 Splinter

Custom

To properly track Motorola VHF and UHF systems and rebanded 800 MHz systems, you should select "Custom" and enter what is known as the base frequencies (Lower and Upper), the spacing frequencies and channel offsets for each System.

To select the custom Band Plan number, turn the [Scroll Control] to select its number from 1 to 6.

Band Plan 1

Band Plan 2

Band Plan 3

Band Plan 4

Band Plan 5

Band Plan 6

Then press[E / yes / gps]. You are then prompted to set the detailed information of band plan.

- Set Base Freq
- Set Offset
- Set Spacing

When you select “Set Base Freq”, you are then prompted to “Input Lower” then “Input Upper”. Use the number keys and decimal key to input frequencies. Press [E / yes / gps] to set the frequency. If the entered frequency is out of band, “Out of Band” will be shown with an error tone. Press any key to go back to editing the base frequency.

When you select “Set Offset”, you can set the channel offset for the band plan entry. You can set the Offset from -1023 to +1023. Enter the absolute value using the number keys. If you input a value over 1023, “Out of Range” and “Set Max? (Y/N)” will be shown. Press [. / no / pri] to return to editing state. Press [E / yes / gps] to set the value to maximum number (1023) and you will be prompted to “Select Polarity”. Select “+ Polarity” or “- Polarity”, then press [E / yes / gps] to confirm the setting.

When you select “Set Spacing”, the following spacing values can be selected:

5.00 kHz	6.25 kHz	10.00 kHz	12.50 kHz	15.00 kHz
18.75 kHz	20.00 kHz	25.00 kHz	30.00 kHz	31.25 kHz
35.00 kHz	37.50 kHz	40.00 kHz	43.75 kHz	45.00 kHz
50.00 kHz	55.00 kHz	56.25 kHz	60.00 kHz	62.50 kHz
65.00 kHz	68.75 kHz	70.00 kHz	75.00 kHz	80.00 kHz
81.25 kHz	85.00 kHz	87.50 kHz	90.00 kHz	93.75 kHz
95.00 kHz	100.00 kHz			

Turn the [Scroll Control] to select. Press [E / yes / gps] to set the Spacing.

Note: If Base Freqs haven’t been set yet, the setting of Offset and Spacing will not be accepted.

For rebanded systems, the most likely settings for Base (Lower and Upper), Offset and Spacing in the table are:

Band Plan	Base Freq (Lower)	Base Freq (Upper)	Offset	Polarity	Spacing
1	851.025MHz	854.000MHz	440	+	25 kHz
2	851.0125MHz	868.9875MHz	0	+	25 kHz

Set Site Type

You can select the site type for EDACS WIDE/NARROW system.

Wide(Standard)	EDACS wide site
Narrow	EDACS narrow site

Press [E / yes / gps] to accept and return to the previous menu.

Set Frequencies

You can select a stored frequency or enter a new system frequency.

Frequencies already set are displayed as a Menu Item and "New Frequency" is displayed as the last one.

For example, if you have stored "851.0125MHz" and "868.9875MHz", the selectable items are as follows:

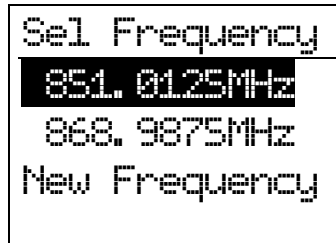

Note: At first, only "New Frequency" is displayed.

The limit of trunk frequencies in a site is 500 - 1000. You can store up to 1000 total TGID and trunk frequencies. When it is over the limit, the scanner sounds an Error Tone.

If "New Frequency" is selected by pressing [E / yes / gps], the scanner skips the next selection. Then it goes to Edit Frequency menu automatically to enter the frequency.

If you select a stored frequency and press [E / yes / gps], the scanner prompts for the next setting items.

- Edit Frequency
- Set Number Tag*
- Set Lockout
- Volume Offset (SCAT systems only)
- Delete Frequency
- New Frequency

Turn [Scroll Control] and press [E / yes / gps] to go to each setting.

*This setting is displayed only when the system type is "EDCS SCAT".

Edit Frequency

You can enter or edit the frequency by pressing the number keys and decimal key.

Press [E / yes / gps] to store the frequency.

The scanner does not allow frequency duplication in a System. If the entered frequency is already stored into that System, the scanner sounds an Error Tone and displays "Frequency Exists".

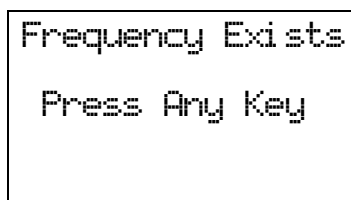

Then press any key to return to the editing mode.

Valid frequency ranges are in Band Coverage. If the entered frequency is out of range, the scanner sounds an Error Tone and displays "Out of Band". And the scanner stays on this state.

If the type of System is EDACS WIDE/NARROW or LTR, the scanner prompts for a LCN (logical channel number). Press [0 - 9] to enter the LCN.

Note: You can only enter the LCN suitable for each System type. EDACS: 1-30, LTR: 1-20.

Press [E / yes / gps] to store the LCN and return to the previous menu. The scanner does not allow LCN duplication in a System. If the entered LCN is already stored, the scanner sounds an Error Tone and displays "LCN Exists".

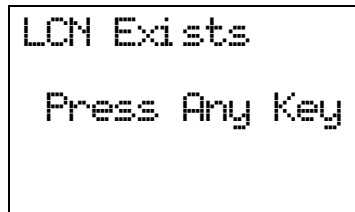

Set Number Tag

The channel Number Tag can be set in this menu.

Press a number key to input the number tag. Press [. / no / pri] to clear the input.

Press [E / yes / gps] to accept the setting and return to the previous menu.

Note: The valid setting range is from 0 to 999. Blank means a number tag not assigned.

This option is only shown when system type is EDACS SCAT.

Set Lockout

This option allows you to lock or unlock the current frequency. When the frequency is locked out, the scanner does not check it.

Unlocked	The frequency is unlocked.
Temporary L/O	The frequency is temporarily locked out.
Lockout	The frequency is locked out.

Press [E / yes / gps] to accept the selection and return to the previous menu.

Volume Offset (SCAT systems only)

This option is used to set a volume offset for each site frequency. The feature can let you adjust the volume level relative to other channels when the frequency is active. Setting level are:

- 3
- 2
- 1
- 0
- +1
- +2
- +3

Press [E / yes / gps] to accept the selection and return to the previous menu.

Delete Frequency

You can delete the current frequency and all associated settings by select this menu item. The scanner prompts "Confirm Delete?" to confirm deletion.

Press [E / yes / gps] to delete the current frequency.

Press [. / no / pri] to cancel deletion and return to the previous menu.

New Frequency

Press [E / yes / gps] to create a new frequency and go to Set Frequencies.

Set Modulation

You can select the modulation from following settings.

- Auto* The scanner uses the modulation normal for the frequency's band.
- NFM The scanner uses Narrowband FM demodulation.
- FM The scanner uses FM demodulation.

Press [E / yes / gps] to accept the entry and return to the previous menu.

*If the system type is "MOT", "LT" or "EDCS SCAT", when the default modulation of the frequency in Band Defaults is not FM or NFM, the scanner will operate as FM.

Set Attenuator

You can attenuate RF reception on the frequency.

- On The frequency will be attenuated.
- Off The frequency will not be attenuated.

Press [E / yes / gps] to accept the selection and return to the previous menu.

Set Lockout

This option allows you to lock or unlock the current site. When the site is locked out, the scanner does not check it.

Unlocked	The site is unlocked.
Temporary L/O	The site is temporarily locked out.
Lockout	The site is locked out.

Press [E / yes / gps] to accept the selection and return to the previous menu.

Set Hold Time

In Trunked Systems, this setting is applied only when a Control Channel can be received.

If no Control Channel can be received, the scanner goes to the next system immediately.

You change this setting from 0 to 255 seconds by pressing the number keys.

Press [E / yes / gps] to accept the entry and return to the previous menu.

If you enter over "255" for the Hold Time, the scanner prompts "Out of Range" and "Set Max? (Y/N)". When [E / yes / gps] is pushed, maximum value 255 will be set.

It returns to the edit state, if you press [. / no / pri].

Set LocationInfo

You can set the location data for the current site.

The setting items are:

- Set Latitude
- Set Longitude
- Set Range
- Set GPS Enable

Turn [Scroll Control] to select the item and Press [E / yes / gps] to go to the settings.

Set Latitude

Press the number keys to enter latitude data. Press any number key when the cursor is in the last position to toggle between south latitude (S) and the north latitude (N).

Press [E / yes / gps] to accept and return to the previous menu.

If “DMS:DDD°MM'SS.ss” is selected in Set Pos Format, the display is the following.

```
Set Latitude
-----
00°00' 00.00  N
```

If “DEG:DDD.dddddd” is selected in Set Pos Format, the display is the following.

```
Set Latitude
-----
00.000000  N
```

Set Longitude

Press the number keys to enter longitude data. Press any number key when the cursor is in the last position to toggle between east longitude (E) and west longitude (W).

Press [E / yes / gps] to accept and return to the previous menu.

If “DMS:DDD°MM'SS.ss” is selected in Set Pos Format, the display is the following.

```
Set Longitude
-----
00°00' 00.00  W
```

If “DEG:DDD.dddddd” is selected in Set Pos Format, the display is the following.

```
Set Longitude
-----
00.000000  W
```

Set Range

In this menu, the setting unit is determined by the setting in Set Unit.

When you select "mile" in Set Unit, the displayed unit will be mile.

When you select "km" in Set Unit, the displayed unit will be km.

The valid setting range is from 0.5 to 125.0, in 0.5 steps.

Press [E / yes / gps] to accept the setting and return to the previous menu.

Set GPS Enable

When this option is set to "On", the scanner will control L/O status of this site by position information received from a GPS.

On The L/O state of this site is automatically controlled by position information.

Off The L/O state of this site is not influenced by GPS.

Press [E / yes / gps] to accept and return to the previous menu.

Delete Site

You can delete the current site and all associated settings by select this menu item. The scanner prompts "Confirm Delete?" to confirm deletion.

Press [E / yes / gps] to delete the current site.

Press [. / no / pri] to cancel deletion and return to the previous menu.

New Site

Press [E / yes / gps] to create a New Site and goes to Creating a New Site.

Program Group

This menu lets you select a Channel Group for programming or create a new Channel Group.

Names of Groups already created are displayed as Menu Items. The order of Groups is sorted by setting of Quick Key for Groups (See: [Set Quick Key](#)) as 1, 2, 3, ... , 9, 0 and "." (=Not assigned). The order of Groups belonging to same Quick Key is determined by the assigned order. "New Group" is displayed as the last item.

For example, there are two groups named "Group 1" and "Group 2", selectable items are as follows:

- Group 1
- Group 2
- New Group

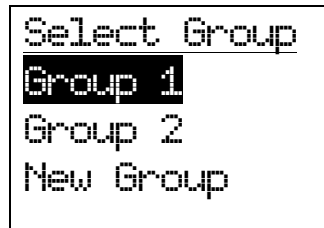

Note: At first, only "New Group" is displayed.

The limit of Groups in a System is 20. So, if you try to select "New Group" when there are already 20 Groups in that System, the scanner displays "Over Limit" and sounds an Error Tone. Then it returns to Group selection.

Select the Group Name or "New Group" and press [E / yes / gps] to go to the Group Settings Menu.

If the "New Group" is selected, the scanner appends a Group to the System with a default Group name of "Group xx". (xx: 1-2 digits sequential number)

Group Settings

This menu has following group settings:

- Edit Name
- Set Quick Key
- Edit Channel
- Set LocationInfo
- Set Lockout
- Delete Group
- New Group

Note: The name of the Group will be shown in the first line of the display.

Press [E / yes / gps] to go to each setting.

Edit Name

Here, you can name the Channel Group.

Refer to FONT DATA for the characters that can be entered.

Press [E / yes / gps] to accept the name entered. The scanner returns to the previous menu.

Set Quick Key

This option lets you select which Group Quick Key will rapidly enable/disable the Group when the scanner is in the scanning mode.

Allowed settings are from 0 to 9 and not assigned. You can assign more than one Channel Group to the same Quick Key.

Press [1 – 9, 0] to assign each number as a Group Quick Key.

Press [. / no / pri] to assign to no Group Quick Key.

Press [E / yes / gps] to accept and return to the previous menu.

Edit Channel

See: *Program Channel*.

Set LocationInfo

You can set location data for the current channel group so it is automatically locked and unlocked as you change location (when using an external GPS).

You set the following items:

- Set Latitude
- Set Longitude
- Set Range
- Set GPS Enable

Turn [Scroll Control] to select an item to set and press [E / yes / gps] to go to the settings.

Set Latitude

Enter the latitude data using the number keys.

Press any number key when the cursor is in the last position to toggle between south latitude (S) and north latitude (N).

Then press [E / yes / gps] to accept and return to the previous menu.

If “DMS:DDD⁰MM'SS.ss” is selected in *Set Pos Format*, the display is the following.

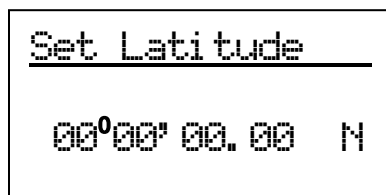

If "DEG:DDD.dddddd" is selected in Set Pos Format, the display is the following.

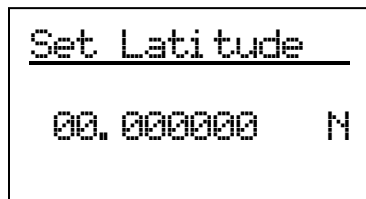

Set Longitude

Enter the longitude data using the number keys.

Press any number key when the cursor is in the last position to toggle between west longitude (W) and east longitude (E).

Then press [E / yes / gps] to accept and return to the previous menu.

If "DMS:DDD°MM'SS.ss" is selected in Set Pos Format, the display is the following.

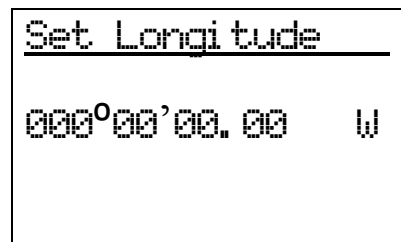

If "DEG:DDD.dddddd" is selected in Set Pos Format, the display is the following.

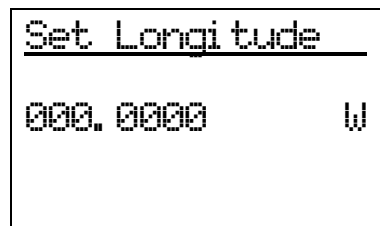

Set Range

In this menu, the setting unit depends on the setting in Set Unit.

When you select "mile" in Set Unit, the displayed unit is mile.

When you select "km" in Set Unit, the displayed unit is km.

The valid setting range is from 0.5 to 125.0 in 0.5 steps.

Press [E / yes / gps] to accept the setting and return to the previous menu.

Set GPS Enable

When this option is set to "On", the scanner will control the L/O status of this channel group using position information supplied from a connected GPS.

- On The Channel Group's L/O state is automatically controlled by position information.
- Off The Channel Group's L/O state is not influenced by GPS.

Press [E / yes / gps] to accept and return to the previous menu.

Set Lockout

This option allows you to lock or unlock the current channel group. When the channel group is locked out, the scanner does not check it.

- Unlocked The channel group is unlocked.
- Temporary L/O The channel group is temporarily locked out.
- Lockout The channel group is locked out.

Press [E / yes / gps] to accept the selection and return to the previous menu.

Delete Group

You can delete the current channel group and all associated settings by select this menu item. The scanner prompts "Confirm Delete?" to confirm deletion.

Press [E / yes / gps] to delete the current channel group.

Press [. / no / pri] to cancel deletion and return to the previous menu.

New Group

Press [E / yes / gps] to create a new group and go to Group Settings.

Program Channel

You can select a Channel for programming or add a new Channel.

Names of Channels already added are displayed as Menu Items. The order of Channels is sorted by created or pasted order. "New Channel" is displayed as the next to last Channel. "Paste Channel" will be displayed as the last item if a Channel has previously been copied from a compatible (same typed) System / Site.

For example, there are the Channel named "Channel A" and a Channel was copied, selectable items are as follows:

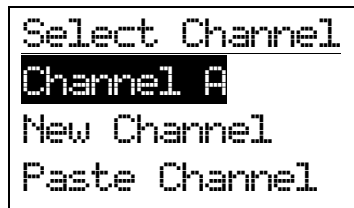

Note: At first, only "New Channel" is displayed.

For conventional systems, the limit of Channels for one system is 1000. So, if you select "New Channel" and enter a frequency when there are already 1000 channels in the system, the scanner displays "Over Limit" and sounds an Error Tone. Then it returns to channel selection.

For trunked Systems, the limit of Channels for one system is 500. So, if you select "New Channel" and enter a TGID when there are already 500 Channels in the system, the scanner displays "Over Limit" and sounds an Error Tone. Then it returns to Channel selection.

The limit of Channels and System frequencies is 9000. If you select "New Channel" and enter the frequency or TGID when there are already 9000 Channels and System frequencies, the scanner displays "Over Limit" and sounds an Error Tone. Then it returns to Channel selection.

Select the Channel Name and press [E / yes / gps] to go to the Channel Settings Menu.

Select "Paste Channel" and press [E / yes / gps] to paste the Channel. All settings are copied, then the scanner goes to the Channel Settings Menu.

If the "New Channel" is selected by pressing [E / yes / gps], you need to enter the frequency for a conventional System's Channel or the TGID for a trunked system Channel.

Input Frequency:

You must enter a frequency.

Note: Please see: Band Coverage for acceptable frequencies.

Press [E / yes / gps] to set the frequency. The channel name is set to the frequency as a default name as "xxxx.xxxxMHz". Then the scanner goes to the Channel Settings Menu.

Press [Menu] to return to the previous selection and cancel adding a Channel.

Input TGID:

You must enter a TGID.

You can input only a TGID in the format suitable for the site type.

Motorola Type ID (Decimal Format ID) :

When the custom Fleet Map setting for a MOT system is not all Size Code 0 for Blocks, the scanner treats the System as a Motorola Type I.

Press the number keys to enter the Block number, Fleet number and SubFleet number.

Press the decimal key to enter a hyphen.

Note: 1 digit Block number, 2 - 3 digits Fleet number, hyphen and 1 - 2 digits SubFleet number.

When the set Preset Fleet Map or custom Fleet Map has all Blocks with Size Code 0, the scanner treats the System as a Motorola Type II.

Press the number keys to enter the TGID.

Note: Numbers only (up to 5 digits)

Motorola Type ID (Hex Format ID) :

Turn [Scroll Control] to select Hex character from "0" to "F".

Press [4 / LEFT / ifx] or [6 / RIGHT / disp] to move cursor left or right.

Press [E / yes / gps] to set the Hex ID.

Note: When the custom Fleet Map setting set to Size Code 0 for all Blocks, the scanner treats the System as a Motorola Type I or Hybrid system. In these cases Hexadecimal input will be treated as same as Decimal ID. (see *FLEET MAP* for detail)

E.g. If you enter "1", "2" as a Type I Hex ID, it will be treat as 12, not 0x12.

EDACS ID :

For EDACS Wide/Narrow systems.

Press the number keys to enter the Agency number.

Press the decimal key to enter a hyphen.

Press the number keys to enter the Fleet number and SubFleet number.

Note: Agency number (00 - 15), hyphen, Fleet number (00 - 15) and SubFleet number (0 - 7)

The scanner does not accept all zero ID ("00-000").

You can omit the SubFleet number as a wildcard.

You can omit Fleet numbers and SubFleet numbers as wildcards.

LTR ID :

For LTR systems.

Press the number keys to enter the Area code, Home repeater and User ID.

Note: 6 digit numbers; Area code (0 or 1), Home repeater (01 - 20), User ID (000 - 254)

I-Call (Motorola, EDACS) :

For any MOT System, EDCS Wide and Narrow System.

First, press the decimal key to enter "i" for I-Call. Then press the number keys to enter the ID.

Note: For details of TGID format, please see: *TGID FORMAT FOR TRUNKED SYSTEM.*

Press [E / yes / gps] to set the TGID. The Channel Name is set to the TGID as default name as "ID:xxxx".
Then the scanner goes to the Channel Settings Menu.

Press [Menu] to return to the previous selection and cancel adding a Channel.

Channel Settings

The following settings are available for channels.

- Edit Name
- Edit Frequency
- Edit TGID
- Set CTCSS/DCS
- Set Number Tag
- Set Modulation
- Set Attenuator
- Set Priority
- Set Alert
- Set Lockout
- Volume Offset
- Copy Channel
- Delete Channel
- New Channel

The specific settings available depend on the current system type.

See *Channel Settings* for details of the differences.

Note: The first Line in the display shows the name of the Channel in Menu Display.

Edit Name

You can provide a name for the channel.

Refer to FONT DATA for the characters that can be entered.

Press [E / yes / gps] to accept the name entered. The scanner returns to the previous menu.

Edit Frequency

If you select to edit the frequency, the scanner displays the current frequency in edit mode.

See *Edit Frequency*.

Edit TGID

If you select to edit the TGID, the scanner displays the current ID. You can use the keypad to change the ID.

When you press [E / yes / gps] to accept, the scanner checks for valid data and returns to the previous menu.

If the ID is invalid, the scanner shows “Bad TGID” and “Press Any Key” and sounds an error tone. Press any key to return to the editing state.

Set CTCSS/DCS

You can set the CTCSS/DCS options from the following items for conventional systems.

Off	The scanner ignores all tones and opens squelch on any signal.
Search	The scanner displays any tone being used, but opens squelch on any signal.
CTCSS	The scanner prompts you for the appropriate setting. Squelch will open for this Channel only if the code matches.
DCS	The scanner prompts you for the appropriate setting. Squelch will open for this Channel only if the code matches.
Set Lockout	The scanner prompts you to select CTCSS/DCS settings to ignore. Squelch will not open for this Channel only if the code matches.

*For AM or WFM modulation, this setting will be ignored.

If you select “Off” or “Search”:

The scanner returns to the previous menu.

If you select “CTCSS” or “DCS”:

You can select the CTCSS frequency or DCS code. (Refer to CTCSS FREQUENCY and DCS CODE for selectable frequencies and codes.)

Turn [Scroll Control] to select.

Press [E / yes / gps] to set and return to the previous menu.

If you select “Set Lockout”:

You can select a CTCSS or DCS for lockout.

Turn [Scroll Control] to select and press [E / yes / gps] key to lock it out. Then the scanner returns to the previous menu.

Set Number Tag

The Channel Number Tag can be set in this menu.

Press a number key to input the number tag. Press [./no/pri] to clear the input.

Press [E / yes / gps] to accept the setting and return to the previous menu.

Note: The valid setting range is from 0 to 999. Blank means a number tag not assigned.

Set Modulation

You can select the modulation from the following settings.

Auto	The scanner uses the modulation normal for the frequency’s band. (See: <u>Band Defaults</u>)
AM	The scanner uses AM demodulation.
NFM	The scanner uses Narrowband FM demodulation.
FM	The scanner uses FM demodulation.
WFM	The scanner uses Wideband FM demodulation.
FMB	The scanner uses FM Broadcast demodulation.

Press [E / yes / gps] to accept the entry and return to the previous menu.

Set Attenuator

You can attenuate RF reception on the frequency.

- On The frequency will be attenuated.
- Off The frequency will not be attenuated.

Press [E / yes / gps] to accept the selection and return to the previous menu.

Set Priority

This option sets the Channel as a Priority Channel. You can set this On for each Channel independently. See PRIORITY SCAN to see how this works for conventional. See PRIORITY ID SCAN to see how this works for trunking.

- On The Channel is treated with priority.
- Off The Channel is not treated with priority.

Press [E / yes / gps] to accept the entry and return to the previous menu.

Note: Although any conventional frequency can be set as a priority channel, the scanner is unable to scan over the number of priority channels that was set at menu MaxCHs/Pri-Scan. If unlocked priority channels are over this setting, only that portion of the priority channels will be scanned for priority.

Set Alert

Channel alert options can be set using this menu.

- Set Alert Tone
- Set Alert Light

Press [E / yes / gps] to enter the setting.

Set Alert Tone

You can select whether the scanner should sound an Alert Tone when this Channel becomes active*.

- Off No alert sounds.
- Alert 1-9 The scanner sounds Alert1-9 with the Channel becomes active.

If you select "Off", the scanner returns to the previous menu.

If you select "Alert1-9", the scanner goes to Alert Level selection.

- Auto The alert is set to the same volume as normal audio.
- Level1-15 The alert is fixed to the selected audio level.

Press [E / yes / gps] to accept the entry and return to the previous menu.

Set Alert Light

You can select whether the scanner should have an alert light when this Channel becomes active*.Alert Light Pattern selections.

Off	The alert light will not turn on
On	The alert light is set to on
Slow Blink	The alert light blinks slowly
Fast Blink	The alert light blinks fast

Press [E / yes / gps] to accept the entry and return to the previous menu.

*"Active" means that the scanner received a signal on the Channel in Scan Mode or Scan Hold Mode, or the Channel is selected in Scan Hold Mode.

Set Lockout

This option allows you to lock or unlock the current channel. When the channel is locked out, the scanner does not check it.

Unlocked	The channel is unlocked.
Temporary L/O	The channel is temporarily locked out.
Lockout	The channel is locked out.

Press [E / yes / gps] to accept the selection and return to the previous menu.

Volume Offset

This option is used to set a volume offset for each channel. The feature can let you adjust the volume level relative to other channels when the frequency is active. Setting level are:

- 3
- 2
- 1
- 0
- +1
- +2
- +3

Press [E / yes / gps] to accept the selection and return to the previous menu.

Copy Channel

You can copy a Channel and all associated settings by selecting this menu item.

The Channel Information is copied to the Copy Buffer when this item is selected. The Copy Buffer just has the last copied Channel Information.

The scanner displays "Copy Channel" and "Copied to Buffer" when you press [E / yes / gps].

Note: Pasting a Channel will not clear this Copy Buffer (See: Edit Channel)

Delete Channel

You can delete the current channel and all associated settings by select this menu item. The scanner prompts "Confirm Delete?" to confirm deletion.

Press [E / yes / gps] to delete the current channel.

Press [. / no / pri] to cancel deletion and return to the previous menu.

New Channel

Press [E / yes / gps] to create a New Site and go to *Channel Settings*.

Program Location

You can select the any Location for programming or create a new Location.

First, select the location type to edit or create from the following types:

- POI
- Dangerous Xing
- Dangerous Road

Select an existing location or New Location. For a POI, it goes to *POI Settings*. For a “Dangerous Xing” or “Dangerous Road”, it goes to *Dangerous Xing / Road Settings*.

Note: You can review all created Locations in Review Location Mode. (See *Review Location Mode*.)

POI Settings

You can set the following items.

- Edit Name
- Set Type
- Set Alert
- Set LocationInfo
- Set Range
- Set Lockout
- Delete Location
- New Location

Turn [Scroll Control] and press [E / yes / gps] to go to each setting.

Dangerous Xing / Road Settings

You can set the following items.

- Edit Name
- Set Type
- Set Alert Volume
- Set Alert Light
- Set LocationInfo
- Set Heading
- Set Speed Limit
- Set Lockout
- Delete Location
- New Location

Turn [Scroll Control] and press [E / yes / gps] to go to each setting.

Edit Name

You can name the location.

Refer to FONT DATA for the characters that can be entered.

Press [E / yes / gps] to *accept* the name entered. The scanner returns to the previous menu.

Set Type

This option can be used to select the location type.

- POI
- Dangerous Xing
- Dangerous Road

Turn [Scroll Control] to select the type and press [E / yes / gps] to accept it.

Then the scanner returns to the previous menu.

Set Alert

Set Alert Tone

You can select whether the scanner should sound an Alert Tone when approaching the set Location.

- Off No alert sounds.
- Alert 1 - 4 The scanner sounds Alert1 - 4 when you approach the Location.

If you select "Off", the scanner returns to the previous menu.

If you select "Alert1 - 4", the scanner goes to the Alert Level selection.

- Auto The alert is set to the same volume as normal audio.
- Level1 - 15 The alert is fixed to the selected audio level.

Set Alert Light

You can select whether the scanner should have an Alert Light when you approach the set Location.

Alert Light Pattern selections.

- Off The alert light will not turn on
- On The alert light is set to on
- Slow Blink The alert light blinks slowly
- Fast Blink The alert light blinks fast

Press [E / yes / gps] to accept the entry and return to the previous menu.

Note: This setting menu appears only in "POI".

Set Alert Volume

This option can be used to set the alert level.

- Auto The alert is set to the same volume as normal audio.
- Level1-15 The alert is fixed to the selected audio level.
- Off No alert sounds.

Press [E / yes / gps] to accept the data and return to the previous menu.

Note: This setting menu appears in "Dangerous Xing" and "Dangerous Road".

Set Alert Light

This option can be used to set Alert Light.

Alert Light Pattern selections.

Off	The alert light will not turn on
On	The alert light is set to on
Slow Blink	The alert light blinks slowly
Fast Blink	The alert light blinks fast

Press [E / yes / gps] to accept the entry and return to the previous menu.

Note: This setting menu appears in “Dangerous Xing” and “Dangerous Road”.

Set LocationInfo

You use this option to set the location data.

First, you set the latitude.

Press the number keys to enter latitude data. Press any number key when the cursor is in the last position to toggle between south latitude (S) and the north latitude (N).

Press [E / yes / gps] to go to the longitude setting.

Press the number keys to enter longitude settings. Press any number key when the cursor is in the last position to toggle between east longitude (E) and west longitude (W).

Press [. / no / pri] to jump to the next input area. For example, press [. / no / pri] on Degree Number for DMS to jump to the Minute Number. Press this again to jump to the second number. Press [. / no / pri] or a number key on N/S or W/E to toggle these settings.

Set Range

This option sets the range for a POI.

In this menu, the setting unit depends on the setting in *Set Unit*.

When you select “mile” in *Set Unit* the displayed unit will be miles.

When you select “km” in *Set Unit* the displayed unit will be kms.

The valid setting range is from 0.05 to 4.0, by 0.05 steps.

Press [E / yes / gps] to accept the setting and return to the previous menu.

Note: This setting menu appears only in “POI”.

Set Heading

This option sets the heading direction-based alerts.

The options are:

All Range	The scanner always sounds an alert and turns on the Alert Light when you go into range of the location.
North (0°)	South (180°)
NE (45°)	SW (225°)
East (90°)	West (270°)
SE (135°)	NW (315°)

Press [E / yes / gps] to accept the and return to the previous menu.

Note: This setting menu appears in “Dangerous Xing” and “Dangerous Road”.

Set Speed Limit

This option sets the speed limit for location alerts. The scanner only alerts when your speed is over this setting.

In this menu, the setting unit depends on the setting in Set Unit.

When you select “mile” in Set Unit the displayed unit will be “mph”.

When you select “km” in Set Unit the displayed unit will be “km/h”.

The valid setting range is from 0 to 200, in steps of 1.

Press [E / yes / gps] to accept the entry and return to the previous menu.

Note: This setting menu appears in “Dangerous Xing” and “Dangerous Road”.

Set Lockout

This option allows you to lock or unlock the current location. When the location is locked out, the scanner does not check it.

Unlocked	The location is unlocked.
Temporary L/O	The location is temporarily locked out.
Lockout	The location is locked out.

Press [E / yes / gps] to accept the selection and return to the previous menu.

Delete Location

You can delete the current location and all associated settings by select this menu item. The scanner prompts "Confirm Delete?" to confirm deletion.

Press [E / yes / gps] to delete the current location.

Press [. / no / pri] to cancel deletion and return to the previous menu.

New Location

If you select this in the “POI” setting menu and press [E / yes / gps], the scanner creates a New POI and goes to *POI Settings*.

Or, if you select this item in “Dangerous Xing” or “Dangerous Road”, the scanner creates a New Dangerous location and goes to *Dangerous Xing / Road Settings*.

Srch/CloCall Opt

This menu includes the following:

- Freq Lockouts
- Broadcast Screen
- CTCSS/DCS Search
- Repeater Find
- Max Auto Store
- Set Delay Time
- Set Attenuator

Press [E / yes / gps] to go to each setting.

Each setting in these options is applied to some or all Search Modes*.

*"Search Mode" is Service Search, Custom Search, Quick Search, Search and Store, Close Call and CC Auto Store.

The mode in which a setting is applied showed in the following table.

	Service Search*1	Custom Search*1	Quick Search	Search and Store	Close Call	CC Auto Store	CC Hits System	Band Scope
Freq Lockouts	0	0	0	0	0	0		
Broadcast Screen		0	0	0 ^{*2}	0	0		
CTCSS/DCS Search	0	0	0	0	0	0		
Repeater Find		0	0		0			
Max Auto Store				0		0		
Set Delay Time			0		0		0	
Set Attenuator			0		0	0		0

*1While searching a search range in Search with Scan, these settings are valid.

*2In Search and Store, this setting is valid only when the scanner stores a Custom Search frequency.

Freq Lockouts

You can select from these items.

- Unlock All
- Rvw Search L/O

Press [E / yes / gps] to enter each menu.

Unlock All

Selecting this causes the scanner to prompt "Confirm?" and "Unlock All(Y/N)".

Press [E / yes / gps] to unlock all frequencies. Then the scanner returns to *Freq Lockouts*.

Press [. / no / pri] to cancel this and return to the previous menu.

Note: If no frequencies have been locked, the scanner displays "Nothing Locked".

Press any key to return to the previous menu.

Rvw Search L/O

Allows you to review frequencies that are locked out in Search Mode or Close Call Mode. Any frequency in this list will be skipped if encountered in these modes.

The first Line displays "Unlock?(Y/N)" and the remaining lines display locked out frequencies.

Turn [Scroll Control] to choose frequencies.

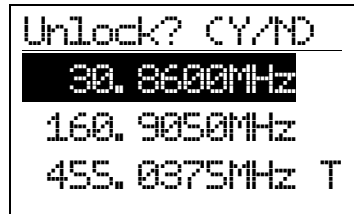

“T” will be displayed following the frequency if it is a temporary lockout frequency.

Press [E / yes / gps] to unlock the displayed frequency and change to the next locked out frequency.

Press [. / no / pri] to advance to the next locked out frequency.

Press [Menu] to return the previous menu.

Note: If no frequencies have been locked, the scanner displays "Nothing Locked".

If you unlock the last frequency, the scanner displays "Nothing Locked".

Broadcast Screen

This option sets whether the scanner screens broadcast frequencies.

You can select the following items.

- Set All Band On
- Set All Band Off
- Set Each Band
- Program Band

Press [E / yes / gps] to enter each menu.

Set All Band On

This function can turn all bands On.

When you press [E / yes / gps], the scanner displays “All Band” and “On”.

The scanner then returns to the previous menu.

Set All Band Off

This function can turn all bands Off.

When you press [E / yes / gps], the scanner displays “All Band” and “Off”.

The scanner then returns to the previous menu.

Set Each Band

You can turn on or off each of the following bands.

Pager	:	On/Off	:	Various, according to FCC allocation
FM	:	On/Off	:	88.1000 - 107.9000 MHz
UHF TV	:	On/Off	:	470.0000 - 512.0000 MHz
VHF TV	:	On/Off	:	54.0000 - 72.0000 MHz
			:	76.0000 - 88.0000 MHz
			:	174.0000 - 216.0000 MHz
NOAA WX	:	On/Off	:	161.6500, 161.7750, 162.4000, 162.4250, 162.4500, 162.4750, 162.5000, 162.5250, 162.5500, 163.2750 MHz
Band 1	:	On/Off		
Band 2	:	On/Off		
:				
Band 10	:	On/Off		

On The scanner ignores hits on the band frequencies.

Off The scanner does not Screen for the band frequencies.

Turn [Scroll Control] to put the cursor focus on the band that you want to change, and press [E / yes / gps] to change the setting.

Then press [Menu] to return to the previous menu.

Program Band

You can set up to 10 custom band screens. Select a band and press [E / yes / gps] to go to the limit setting.

You need to set a lower and upper limit frequency. First, enter the lower limit frequency and store it by pressing [E / yes / gps]. Next, enter the upper limit frequency and press [E / yes / gps] to store the upper limit. The scanner returns to the previous menu.

Note: If the lower frequency is larger than the upper frequency, the setting is automatically changed.

CTCSS/DCS Search

This option sets whether the scanner will search for a CTCSS/DCS code when it finds an active frequency.

Off The scanner does not search for CTCSS/DCS codes.

On The scanner searches for CTCSS/DCS codes. If the scanner detects the code, it displays the found code.

Press [E / yes / gps] to set this setting and return to the previous menu.

Note: For AM, WFM or FMB modulation, this setting is ignored and the scanner treats this setting as "Off".

Repeater Find

This option sets whether the scanner attempts to locate the transmission on a repeater output frequency when it detects a transmission on a common repeater input frequency.

- On The scanner automatically applies repeater reverse to detected transmissions. If the scanner can detect the transmission on the output frequency, it displays "Repeater Found" on the display, and remains on the output frequency. If it does not detect the transmission on the output frequency or it lost the found signal, the scanner remains on the transmission on the original frequency.
- Off The scanner does not perform Repeater Find.

Press [E / yes / gps] to set this setting and return to the previous menu.

Note: You cannot lock out the Repeater frequency. And Repeater frequencies are not related to the locked out frequency list of *Freq Lockouts*.

Max Auto Store

This setting controls how many hits the scanner will automatically store in either Search and Store or Close Call Auto Store.

When the scanner has saved the maximum number of hits set by this setting, it stops storing.

When there are already more auto-stored Channels than the number of Max Auto Store, the scanner will not perform Auto Store operation.

The valid setting range is from 1 to 256.

Press the number keys to enter the number.

Press [E / yes / gps] to set this setting. Then return to previous menu.

If you enter 0, the scanner prompts "Out of Range" and " Set Min? (Y/N)". Press [E / yes / gps] to set the value to minimum "1". Or, press [. / no / pri] to return to editing state and the entered value is set to "1".

If you enters over 256, the scanner prompts "Out of Range" and "Set Max? (Y/N)". Press [E / yes / gps] to set the value to maximum "256". Or, press [. / no / pri] to return to editing state and the entered value is set to "256".

Set Delay Time

This setting controls how long the scanner stays on frequency after a transmission ends before resuming searching.

Turn [Scroll Control] to select the delay time setting from the following list:

- 10 sec
- 5 sec
- 2 sec
- 0 sec
- 1 sec
- 2 sec
- 5 sec
- 10 sec
- 30 sec

Then press [E / yes / gps] to accept and return to the previous menu.

Set Attenuator

You can select to attenuate RF reception on all frequencies in the search range.

- On The frequencies are attenuated.
- Off The frequencies are not attenuated.

Press [E / yes / gps] to accept the entry and return to the previous menu.

Search for...

This menu includes the following items.

- Service Search
- Edit Service
- Custom Search
- Edit Custom
- Search and Store
- Set Search Key

Press [E / yes / gps] to enter each item.

Service Search

You can select from 12 preset search bands for searching.

- Public Safety
- News
- HAM Radio
- Marine
- Railroad
- Air
- CB Radio
- FRS/GMRS/MURS
- Racing
- FM Broadcast
- Special

Press [E / yes / gps] to exit from Menu Mode and start searching the selected band.

(See: *Service Search*)

Edit Service

Select Service Search Range and press [E / yes / gps] to go to each Search Range Setting.

You can set the following items for each Service Search Range.

- Set Delay Time
- Set Attenuator
- Search with Scan

Press [E / yes / gps] to enter each setting.

Note: The first line in the display shows the name of the selected Service Search.

Set Delay Time

This setting controls how long the scanner stays on frequencies after a transmission ends before resuming searching.

Turn [Scroll Control] to select the delay time setting from the following list:

- 10 sec
- 5 sec
- 2 sec
- 0 sec
- 1 sec
- 2 sec
- 5 sec
- 10 sec
- 30 sec

Then press [E / yes / gps] to accept and return to the previous menu.

Set Attenuator

You can select to attenuate RF reception on all frequencies in the search range.

- On The frequencies are attenuated.
- Off The frequencies are not attenuated.

Press [E / yes / gps] to accept the entry and return to the previous menu.

Search with Scan

You can set the following items.

- Set Quick Key
- Set Startup Key
- Set Number Tag
- Set Lockout
- Set Hold Time

Press [E / yes / gps] to enter each setting.

Set Quick Key

You can select a Quick Key from 0 to 99 or “.” (= Not assigned) by turning [Scroll Control].

Quick Key for search is used to rapidly enable or disable the range. The searching order does not change by this setting.

Press [E / yes / gps] to accept and return to the previous menu.

Set Startup Key

The scanner locks or unlocks the search according to setting of this option by pressing and holding a number key at power-on or while displaying the Opening Screen.

Turn [Scroll Control] to select the Startup Key in this menu. The Startup Key can be set from “0” to “9” and “.” (= Not assigned).

Press [E / yes / gps] to accept the selection and return to the previous menu.

Set Number Tag

A Number Tag can be set in this menu.

Press a number key to input the number tag. Press [./no/pri] to clear the input.

Press [E/yes/gps] to accept the setting and return to the previous menu.

Note: The valid setting range is from 0 to 999. Blank means a number tag not assigned.

Set Lockout

This option allows you to lock or unlock the current search. When the search is locked out, the scanner does not check it.

Unlocked	The search is unlocked.
Temporary L/O	The search is temporarily locked out.
Lockout	The search is locked out.

Press [E/yes/gps] to accept the selection and return to the previous menu.

Set Hold Time

This setting determines the maximum time the scanner is forced to hold and search this range before moving to the next, even if there is no traffic on the frequencies.

You can change the hold time from 0 (the scanner checks all frequencies of the range regardless of time) to 255 seconds by using number keys.

If the setting is something other than "0", the scanner goes to the next system or search when the hold time elapses. However, it does not go to next one while receiving a signal.

Press [E/yes/gps] to accept the entry and return to the previous menu.

If you enter over "255" for the Hold Time, the scanner prompts "Out of Range" and "Set Max? (Y/N)". When [E/yes/gps] is pushed, maximum value 255 will be set.

It returns to the edit state, if you press [./no/pri].

Custom Search

The scanner exits from Menu Mode and goes to Search Mode. Then it starts searching the Custom Ranges. (See: Custom Search)

Edit Custom

You can edit the 10 Custom Search Ranges.

Names of Custom Search Ranges are displayed as Menu items.

For example, if all names are not changed from default name, selectable items are as follows:

Custom 1
Custom 2
:
Custom 10

Select the Name and press [E / yes / gps] to go to Menu of editing Custom settings.

Custom Settings

You can edit the follow settings.

Edit Name
Edit Srch Limit
Set Delay Time
Set Modulation
Set Attenuator
Set Step
Set C-Ch Only
Search with Scan

Press [E / yes / gps] to enter each item.

Note: The first line displays the name of the selected Custom Search.

Edit Name

You can name the custom range.

Refer to *FONT DATA* for the characters that *can be entered*.

Press [E / yes / gps] to accept the name entered. The scanner returns to the previous menu.

Edit Srch Limit

You need to set 2 limits for searching.

First, enter the lower limit frequency and store it by pressing [E / yes / gps].

Next, enter the upper limit frequency and press [E / yes / gps] to store the upper limit

The scanner returns to the previous menu.

Note: If the entered Lower Limit is higher than the entered Upper Limit, the scanner will swap these automatically.

Set Delay Time

This setting controls how long the scanner stays on frequencies after a transmission ends before resuming searching.

Turn [Scroll Control] to select the delay time setting from the following list:

- 10 sec
- 5 sec
- 2 sec
- 0 sec
- 1 sec
- 2 sec
- 5 sec
- 10 sec
- 30 sec

Then press [E / yes / gps] to accept and return to the previous menu.

Set Modulation

You can select the modulation from the following settings.

- | | |
|------|--|
| Auto | The scanner uses the modulation normal for the frequency's band. (See: Band Defaults) |
| AM | The scanner uses AM demodulation. |
| NFM | The scanner uses Narrowband FM demodulation. |
| FM | The scanner uses FM demodulation. |
| WFM | The scanner uses Wideband FM demodulation. |
| FMB | The scanner uses FM Broadcast demodulation. |

Press [E / yes / gps] to accept the entry and return to the previous menu.

Set Attenuator

You can select to attenuate RF reception on all frequencies in the search range.

- | | |
|-----|-------------------------------------|
| On | The frequencies are attenuated. |
| Off | The frequencies are not attenuated. |

Press [E / yes / gps] to accept the entry and return to the previous menu.

Set Step

You can select the search step for Custom Search.

- | | |
|----------|---|
| Auto | Automatically assign the search step based on the band. |
| 5.0 kHz | 15.0 kHz |
| 6.25kHz | 20.0 kHz |
| 7.5 kHz | 25.0 kHz |
| 8.33kHz | 50.0 kHz |
| 10.0 kHz | 100.0 kHz |
| 12.5 kHz | |

Press [E / yes / gps] to accept the setting and return to the previous menu.

Set C-Ch Only

These options let you set whether the scanner tracks talk group activity when it detects a Motorola or LTR control channel. This section has the following menus:

- C-Ch Only Mode
- Set MOT BandPlan

C-Ch Only Mode

You can select how the scanner tracks Motorola System and LTR System. (C-Ch means Control Channel.)

- On The scanner only searches for Motorola and LTR Control Channels.
- Off The scanner treats all signals as normal transmission.

Press [E / yes / gps] to accept the entry and return to the previous menu.

Set MOT BandPlan

You can select one of the following options to assign a band plan that the scanner will use if it detects a Motorola control channel. Note that if the actual received channel does not use the specified band plan, the scanner will not follow voice traffic on the system.

The instructions for doing this are the same as for setting a band plan for a programmed system. See *Edit Band Plan* for option settings.

Search with Scan

This menu is same as the one in the Edit Service Menu.

See *Search with Scan*.

Search and Store

This function lets the scanner search for new frequencies in Custom Search Ranges or Service Search Ranges, or new TGID's on a trunked System.

First, select a System to store the found Channels into. The scanner displays all created Systems. Turn [Scroll Control] to select the System. Press [E / yes / gps] to make the selection.

If there are no Systems, you cannot perform this function. The scanner sounds an Error Tone and displays "No System Stored". Press any key to return to the previous menu.

Note: In this function, the scanner ignores the setting of Repeater Find.

For Conventional System

If a conventional System is selected, the scanner prompts you for "Custom Search" and Service Search ranges. Turn [Scroll Control] to select the kind of search to use.

- Custom Search
- Public Safety
- News
- HAM Radio
- Marine
- Railroad
- Air
- CB Radio
- FRS/GMRS/MURS
- Racing
- FM Broadcast
- Special

Once a search range is selected by pressing [E / yes / gps], any time a frequency in that search range goes active, the scanner checks to see if that frequency has been previously stored in that System. If so, it resumes searching. Otherwise, it stores the frequency into the Group named "Found Channels" (the scanner automatically creates this group if it does not exist). Then it resumes searching.

Note: If all frequencies of the selected search are locked out, the scanner displays "All Locked!" on Second line and it cannot start storing operation. Then it goes to End State. (See: [End Conditions](#))

During Search and Store for a conventional System, "SEARCH AND STORE" scrolls on the second line.

"System Name" and "Search Range Name" are alternately displayed on first line.

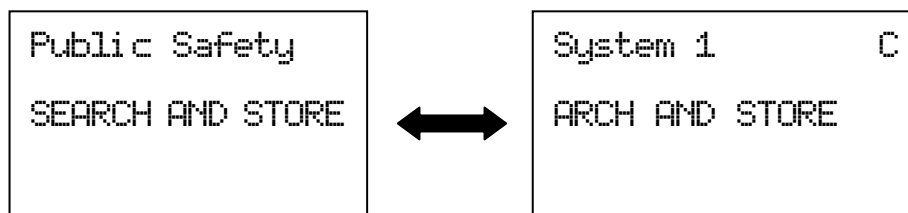

If the scanner finds a frequency, it performs duplication check in the System and displays "Memory Check" on second line. And while storing the frequency to Memory, it displays "Storing" on second line.

For Trunked System

If a trunked System is selected, you will be asked to select a site. If no site is stored in that system, message "No Site Stored Press Any Key" will be displayed and the scanner will sound an error tone. After the site is selected, the scanner begins searching that System. Any time a TalkGroup goes active, the scanner checks to see if that TalkGroup has been previously stored in that System. If so, it resumes searching. Otherwise, it stores the TGID into the Group named "Found Channels" (the scanner automatically creates this Group if it does not exist). Then it resumes searching.

If the selected site is locked out, it is unlocked and the scanner starts ID Auto Store on the site.

Note: Search and Store does not work in the following conditions. The scanner sounds an Error Tone, and it displays System Name on first Line and *Error Message* on second line. Then it goes to End State. (See: End Conditions)

Error Condition	Error Message
A System / a Site that has no frequency is selected.	"No Control Chan"
The Quick Key for the System / Site to which that System / Site belongs is turned off.	"Nothing to Scan"
The Group that stores found Channels already has the number of Max Auto Store or more Channels stored.	"Over Limit"

Note: The following selections are invalid. The scanner displays *Error Message* and "Press Any Key". Press any key to return to System selection.

Error Condition	Error Message
EDACS SCAT System is selected.	"Invalid System"
A system that does not store a site that can be selected.	"No Site Stored"

During Search and Store operation for a trunked System, "ID SEARCH AND STORE" scrolls on the second line. System / Site Name is displayed on the first Line.

```
Site 3-1      MOT
ID SEARCH AND ST
  NFM      \ /
SQ: - - - 4 - - - - -
GRP- - - / \ - - - - -
```

If the scanner finds a TGID, it performs a duplication check in the System (the scanner does not show this state). And while storing the TGID into Memory, it displays "Storing" on the second line.

End Conditions

The scanner will stop storing if the number of found frequencies or TGID exceeds Max Auto Store. Then it displays "Limit Reached" and sounds a Confirmation Tone.

When the number of Channels in trunked System exceeds 500, the scanner stops the storing operation. Then it displays "TGID Full".

When it exceeds the limit of Group/Channel creation during a storing operation, the scanner stops the storing operation. Then it displays "Over Limit" and sounds an Error Tone.

If the Memory is full, it displays "Memory Full" on the second line and sounds an Error Tone.

It does not exit from Search and Store Mode automatically.

During "Search and Store" operation or in one of the above-mentioned End State, only the following operations are valid.

Pressing [Hold / 

Pressing [Scan / srch] exits this mode and goes to Scan Mode.

Pressing [Menu] exits this mode and the scanner goes to the Menu Mode. If you exit from Menu Mode, the scanner goes to each Search Mode (selected Search for storing operation).

Pressing [FUNC] + [Menu] also exits from this mode and goes to each Menu.

Note: In this mode, you cannot hear any transmission.

Set Search Key

The scanner has three search keys that let you quickly start a search range: "Search Key 1", "Search Key 2", and "Search Key 3".

Select the number of Search Key and set a search range from the Service Search ranges, Custom Search ranges, Tone-Out and Band Scope.

Press [E / yes / gps] to accept the entry and return to the previous menu.

Close Call

This menu has the following items.

- Close Call Only
- CC Auto Store
- Hits with Scan
- Set CC Mode
- Set CC Override
- Set CC Alert
- Set CC Bands

Note: "CC" means "Close Call".

Press [E / yes / gps] to enter the menu.

Close Call Only

When this item is selected at Close Call, the scanner exits from the Menu Mode and goes to the Close Call Only Mode. Then it starts searching for Close Call hits. (See: Close Call Only, *Page 149*)

CC Auto Store

When this item is selected at Close Call, the scanner exits from the Menu Mode and goes to the CC Auto Store Mode. Then the scanner automatically stores new CC hits (up to the limit set by the Max Auto Store setting) into the Group named "Found Channels" of System named "Close Call" (automatically created if it does not exist).(See: Close Call Auto Store, *Page 150*)

Note: In this mode, you cannot hear any Close Call transmission.

Hits with Scan

These are the settings for the Close Call temporary stored system.

The setting items are as follows.

- Set Quick Key
- Set Number Tag
- Set Lockout
- Set Hold Time

Press [E / yes / gps] to enter the menu.

Set Quick Key

You can select a Quick Key from 0 to 99 or "." (= Not assigned) by turning [Scroll Control]. The Quick Key is only for rapidly enabling or disabling the system and is not for deciding the scan priority.

Press [E / yes / gps] to accept and return to the previous menu.

Set Number Tag

Number Tag can be set in this menu.

Press a number key to input the number tag. Press [./no/pri] to clear the input.

Press [E/yes/gps] to accept the setting and return to the previous menu.

Note: The valid setting range is from 0 to 999. Blank means a number tag not assigned.

Set Lockout

This option allows you to lock or unlock the Close Call system. When the system is locked out, the scanner does not check it.

Unlocked	The system is unlocked.
Temporary L/O	The system is temporarily locked out.
Lockout	The system is locked out.

Press [E/yes/gps] to accept the selection and return to the previous menu.

Set Hold Time

This setting determines the maximum time the scanner is forced to hold and search this range before moving to the next scanning, even if there is no traffic on the frequencies. You can change it from 0 (the scanner checks all frequencies of the range regardless of time) to 255 seconds by using the number keys.

If you choose a setting other than "0", the scanner goes to next system or search when the hold time elapses. However, it does not go to the next one while receiving a signal.

Press [E/yes/gps] to accept the entry and return to the previous menu.

If you enter over "255" for the Hold Time, the scanner prompts "Out of Range" and "Set Max? (Y/N)". When [E/yes/gps] is pushed, maximum value 255 will be set.

It returns to the edit state, if you press [./no/pri].

Set CC Mode

These settings affect when CC actually operates. When it is set to "CC DND" or "CC Pri" with another mode, every 2 seconds the scanner will switch the filter settings to the ones set by the CC Bands option.

Off	Close Call is turned off for all modes.
CC DND	Close Call does not function while monitoring a transmission.
CC Pri	Close Call functions every 2 seconds even if there is a carrier.

Press [E/yes/gps] to set the mode and return to the previous menu.

Note: The Close Call function is not performed in Weather Mode and Tone-Out Mode.

Set CC Override

This mode determines how the scanner will behave when a Close Call signal is detected.

- On The scanner alerts (depending on the CC Alert setting) and displays "CC Found!" then immediately jumps to the Close Call frequency.
- Off The scanner alerts (depending on the CC Alert setting) and displays "CC Found!" and "Press FUNC Key" for the time set at Set CC Pause. If you press [FUNC] or [E / yes / gps] during this time, the scanner jumps to the Close Call frequency.

Detail of this setting : Close Call Search.

Press [E / yes / gps] to accept the entry and return to the previous menu.

Set CC Alert

You can edit these settings.

- Set Alert Tone
- Set Alert Light
- Set CC Pause

Press [E / yes / gps] to enter each item.

Set Alert Tone

This item can select the type and the level alert.

- Off Beep doesn't sound.
- Alert1-9 The scanner sounds Alert1-9 with CC found.

If you select Off, the scanner returns to the previous menu.

If you select Alert1-9, the scanner goes to Alert Level selection.

- Auto The alert is set to the same volume as normal audio.
- Level1-15 The alert is fixed to the selected audio level.

Press [E / yes / gps] to accept the entry and return to the previous menu.

Set Alert Light

You can set whether the scanner should have an alert light when it gets a Close Call hit.

Alert Light Pattern selections.

- Off The alert light will not turn on
- On The alert light is set to on
- Slow Blink The alert light blinks slowly
- Fast Blink The alert light blinks fast

Press [E / yes / gps] to accept the entry and return to the previous menu.

Set CC Pause

This option can set time from the reception of a Close Call hit to when it returns to previous mode.

Turn [Scroll Control] to set from the following item.

- 3 sec
- 5 sec
- 10 sec
- 15 sec
- 30 sec
- 45 sec
- 60 sec
- Infinite

Press [E / yes / gps] to accept the entry and return to the previous menu.

Set CC Bands

This setting controls the band filtering used during Close Call operation.

You can turn on or off the following bands.

VHF Low 1	:	On/Off	:	25.0000	- 53.9800 MHz
VHF Low 2	:	On/Off	:	54.0000	- 107.9000 MHz
Air Band	:	On/Off	:	108.0000	- 136.9916 MHz
VHF High	:	On/Off	:	137.0000	- 224.9800 MHz
UHF	:	On/Off	:	400.0000	- 512.0000 MHz
800MHz+	:	On/Off	:	806.0000	- 823.9875 MHz
				849.0125	- 868.9875 MHz
				894.0125	- 960.0000 MHz
				1240.0000	- 1300.0000 MHz

Turn [Scroll Control] to move the cursor, and press [E / yes / gps] to change the setting.

- On The scanner check Close Call in this Band.
- Off The scanner does not check this Band.

Press [Menu] to return to the previous menu.

Priority Scan

You can set following items in this menu.

- Set Priority
- Set Interval
- MaxCHs/Pri-Scan

Press [E / yes / gps] to enter each setting.

Set Priority

This setting controls how the scanner treats Priority Channels.

You can select the following items.

- Off The scanner provides no special treatment for Priority Channels.
- On The scanner scans all unlocked Channels and also checks Priority Channels.
- Plus On The scanner scans only Priority Channels.

Press [E / yes / gps] to set the Priority function and return to the previous menu.

Set Interval

This menu, lets you set the priority scan active interval time.

Press the number keys to enter the time, press [. / no / pri] to clear the input.

Note: Valid input range is from 1 to 10 sec.

If you enter "0" sec for the interval time, the scanner prompts "Out of Range" and "Set Min?(Y/N)". Press [E / yes / gps] to select the minimum value (1 sec). Press [. / no / pri] to return to the editing state.

If you enter over "10" sec for the interval time, the scanner prompts "Out of Range" and "Set Max?(Y/N)". Press [E / yes / gps] to select the maximum value (10 sec). Press [. / no / pri] to return to the editing state.

MaxCHs/Pri-Scan

You can set the Maximum priority channel numbers that are scanned during one priority scan interrupt using this menu. If there are more scannable priority channels than the value you select, the channels are divided into more than one group and the scanner scans each group in turn.

Note: The valid set range is from 1 to 100 channels.

Press the number keys to input the number. Press [E / yes / gps] to store the setting.

If you enter "0" for the max priority scan channels, the scanner prompts "Out of Range" and "Set Min?(Y/N)". Press [E / yes / gps] to select the minimum value (1 channel). Press [. / no / pri] to return to the editing state.

If you enters over "100" for the max priority scan channels, the scanner prompts "Out of Range" and "Set Max?(Y/N)". Press [E / yes / gps] to select the maximum value (100 channels). Press [. / no / pri] to return to the editing state.

WX Operation

This menu lets you set the following items.

- Weather Scan
- Weather Alert
- Program SAME
- Set Delay Time
- Set Attenuator
- WX Alt Priority

Select "Weather Scan" and press [E / yes / gps] to start Weather Scan.

Select any other and press [E / yes / gps] to enter each setting.

Weather Scan

When this item is selected at WX Operation, the scanner exits from the Menu Mode and goes to Weather Scan Mode. Then it starts scanning the 10 Weather channels normally.

The scanner stops if there is a carrier. If the carrier is lost, it resumes scanning (See: WEATHER SCAN MODE)

Weather Alert

You can select how Weather Scan works. Select from "Alert Only", names of SAME groups and "All FIPS". If the names of the SAME groups are not changed from default setting, the displayed items are as follows.

- Alert Only
- SAME 1
- SAME 2
- SAME 3
- SAME 4
- SAME 5
- All FIPS

If you select Alert Only, the scanner immediately sounds a Weather Alert Siren (for Weather Alert Tone) when it detects the 1050 Hz Weather Alert Tone, then opens squelch and remains on the Weather Channel.

If you select one of the SAME Groups, the scanner attempts to decode the SAME data packets that precede the Weather Alert Tone. Then the scanner sounds a Weather Alert Siren (for Warning, Watch or Advisory) when the received County is the same as the programmed data. It then opens squelch and remains on the Weather Channel.

If you select All FIPS, the scanner sounds a Weather Alert Siren (for Warning, Watch or Advisory) when it decodes the SAME data packets. Then opens squelch and remains on the Weather Channel.

Press [E / yes / gps] to select and the scanner exits from Menu Mode. Then it goes to Weather Scan Mode with this selection.

Program SAME

You can edit the 5 SAME Groups. The names of SAME Groups are displayed as Menu Items. Default names as follows.

SAME 1
SAME 2
SAME 3
SAME 4
SAME 5

Select the Name and press [E / yes / gps] to go to Same Group Editing Menu.

SAME Group Settings

You can set the following items.

Edit Name
Edit County

Press [E / yes / gps] to go to each setting.

Note: The first line displays the name of the SAME Group.

Edit Name

You can name the SAME Group.

Refer to *FONT DATA* for the characters that *can be entered*.

Press [E / yes / gps] to accept the name entered. The scanner returns to the previous menu.

Edit County

Each SAME Group has 8 entries. You can edit the desired FIPS Code. Stored codes are displayed as Menu Items.

For example, if the SAME Group has "043221", "043227" and "-----", selectable items are as follows:

No.1 : 043221
No.2 : 043227
No.3 : -----
:
No.8 : -----

Select the item and press [E / yes / gps] to enter the editing state.

In the editing state, the editing cursor is displayed. Press the number keys to enter the FIPS code. The cursor moves to the right by entering number. Turn [Scroll Control] to choose the cursor position from the left end to next to right end character, or from left end to right end character when there are already entered up to limit of length. Press the decimal key to clear all numbers.

Press [E / yes / gps] to store the code and return to the previous menu.

Note: If you try to store the County before entering all 6 digits, that County is set to "-----" as blank.

Set Delay Time

This setting controls how long the scanner stays on the Weather Channel after a transmission ends before resuming.

Turn [Scroll Control] to select the delay time setting from the following list:

- 10 sec
- 5 sec
- 2 sec
- 0 sec
- 1 sec
- 2 sec
- 5 sec
- 10 sec
- 30 sec

Then press [E / yes / gps] to accept and return to the previous menu.

Set Attenuator

You can attenuate RF reception on the frequency.

- On The frequency will be attenuated.
- Off The frequency will not be attenuated.

Press [E / yes / gps] to accept the selection and return to the previous menu.

WX Alt Priority

This setting determines how the scanner treats the Weather Channels in Scan/Hold Mode Search/Hold Mode and Close Call Mode.

- On The scanner checks the Weather Channels every 5 seconds to check for the presence of a 1050 Hz Weather Alert Tone.
- Off The scanner does not check the Weather Channels.

Press [E / yes / gps] to set this setting and return to the previous menu.

Tone-Out for ...

This menu lets you set the following items.

- Tone-Out Standby
- Tone-Out Setup

Select “Tone-Out Standby” to start monitoring the Tone-out Frequency.

Select “Tone-Out Setup” to go to *Tone-Out Setup*.

Tone-Out Standby

When this item is selected at *Tone-Out for ...*, the scanner exits from Menu Mode and goes to Tone-Out standby Mode.

Tone-Out Setup

You can edit the 10 Tone-Out channels.

The Names of the Tone-Out channels are displayed as Menu Items.

Default names as follows.

- Tone-Out 1
- Tone-Out 2
- Tone-Out 3
- :
- Tone-Out 10

Select the Name and press [E / yes / gps] to go to *Tone-Out Settings*.

Tone-Out Settings

You can edit these settings.

- Edit Name
- Set Frequency
- Set Tone
- Set Delay Time
- Set Alert

Press [E / yes / gps] to go to each setting.

Note: The first line displays the name of selected Tone-Out channel.

Edit Name

You can name the Tone-Out channel.

Refer to *FONT DATA* for the characters that *can* be *entered*.

Press [E / yes / gps] to accept the name entered. The scanner returns to the previous menu.

Set Frequency

You can set the following items.

- Edit Frequency
- Set Modulation
- Set Attenuator

Press [E / yes / gps] to go to each setting.

Edit Frequency

If you select to edit the frequency, the scanner displays the current frequency in edit mode.

Press the number keys and [. / no / pri] to enter the frequency.

Press [E / yes / gps] to return to the previous menu.

Set Modulation

You can select the modulation from following settings.

- Auto* The scanner uses the modulation normal for the frequency's band.
- NFM The scanner uses Narrowband FM demodulation.
- FM The scanner uses FM demodulation.

Press [E / yes / gps] to accept the entry and return to the previous menu.

Set Attenuator

You can attenuate RF reception on the frequency.

- On The frequency will be attenuated.
- Off The frequency will not be attenuated.

Press [E / yes / gps] to accept the selection and return to the previous menu.

Set Tone

You can set the following items.

- Edit Tone A
- Edit Tone B

Press [E / yes / gps] to go to each setting.

Edit Tone

When you select "Edit Tone A" or "Edit Tone B", you can set the frequency for Tone A or B from 250 to 3500 Hz, and 0Hz.

Press [E / yes / gps] to set the Tone frequency and it remains on Tone A / B selection.

Set Delay Time

This setting controls how long the scanner stays on Mute Off state after a transmission ends.

Turn [Scroll Control] to select setting value from:

- 0 sec
- 1 sec
- 2 sec
- 5 sec
- 10 sec
- 30 sec
- Infinite

Then press [E / yes / gps] to accept and return to the previous menu.

Set Alert

You can set these options in this menu.

- Set Alert Tone
- Set Alert Light

Press [E / yes / gps] to enter the setting.

Set Alert Tone

You can set whether the scanner should sound an Alert Tone when a tone-out channel becomes active*.

- | | |
|-----------|--|
| Off | No alert sounds. |
| Alert 1-9 | The scanner sounds Alert1-9 with the Channel becomes active. |

If you select "Off", the scanner returns to the previous menu.

If you select "Alert1-9", the scanner goes to Alert Level selection.

- | | |
|-----------|--|
| Auto | The alert is set to the same volume as normal audio. |
| Level1-15 | The alert is fixed to the selected audio level. |

Press [E / yes / gps] to accept the entry and return to the previous menu.

Set Alert Light

You can select whether the scanner should have alert light when a tone-out Channel becomes active*.

Alert Light Pattern selections.

Off	The alert light will not turn on
On	The alert light is set to on
Slow Blink	The alert light blinks slowly
Fast Blink	The alert light blinks fast

Press [E / yes / gps] to accept the entry and return to the previous menu.

*"Active" means that the scanner detects Tones and Mute state is set to Off.

Wired Clone

Connect two BC346XTs and select this menu to copy and override all data from one to another.

Master
Slave

The scanner you set to Master's data will be copied to the scanner you set to Slave. Then go to Wired Clone Mode. (See: WIRED CLONE MODE)

Settings

You can set the following items from this menu.

- Set Backlight
- Adjust Key Beep
- Battery Option
- Adjust Contrast
- Set C-CH Output
- Set GPS Format
- Set Serial Port
- Band Defaults
- See Scanner Info

Press [E / yes / gps] to enter each setting.

Set Backlight

This menu has the following items.

- Set Mode
- Set Dimmer

Press [E / yes / gps] to enter each setting.

Set Mode

This option can be used to set the backlight activation mode.

You can select from the following options.

- 10 sec
- 30 sec
- Squelch
- Keypress
- Infinite

Press [E / yes / gps] to accept the data and return to the previous menu.

Set Dimmer

This option can be used to set the brightness level of the display.

You can select from the following options.

- High
- Middle
- Low

Press [E / yes / gps] to accept the data and return to the previous menu.

Adjust Key Beep

Adjusts the beep tone volume level.

Auto	Key Beep is set to the same volume as normal audio.
Level 1–15	Key Beep is fixed to the selected volume level.
Off	Key beep is Off.

Press [E / yes / gps] to set the Beep volume level and return to the previous menu.

Battery Option

This menu has the following items.

Set Battery Save
Set Charge Time

Press [E / yes / gps] to enter each setting.

Set Battery Save

This option can be used to set the battery save feature.

On	Set battery save on
Off	Set battery save off

Press [E / yes / gps] to accept the selection and return to the previous menu.

Set Charge Time

This option can be used to set the battery charge time.

Press the number keys to enter the charge time from 1 to 16 hours.

Press [E / yes / gps] to accept the data and return to the previous menu.

Adjust Contrast

This function sets the contrast of the display from "Contrast 1" to "Contrast 15".

Press [E / yes / gps] to accept the selection and return to the previous menu.

Set C-CH Output

The scanner can output the data stream on control channel by using this function.

Off	data stream is not outputted
On	data stream is outputted
Extend	data stream and description are outputted

Press [E / yes / gps] to accept the data and return to the previous menu.

(See *Control Channel Data Stream Output* for detail)

If the baud rate is slow, the scanner cannot output all data streams. Therefore it is recommended you use a baud rate of 115200 bps.

Set GPS Format

You can set the following items for GPS.

- Set Pos Format
- Set Time Format
- Set Time Zone
- Set Unit

Press [E / yes / gps] to go to each setting menu.

Set Pos Format

The option sets the position format for latitude and longitude.

- DMS:DDD⁰MM'SS.ss
- DEG:DDD.dddddd

Note: This setting changes all Location Input displays and the GPS Mode display.

Press [E / yes / gps] to accept the selection and return to the previous menu.

Set Time Format

This option sets the time format.

- 12H The scanner uses 12-hour format.
- 24H The scanner uses 24-hour format.

Press [E / yes / gps] to accept the data and return to the previous menu.

Set Time Zone

This option sets the time zone and daylight savings time.

You can set an offset value from GMT from “-14.0 H” to “+14.0 H” in 0.5H increments.

Press [E / yes / gps] to accept the selection and return to the previous menu.

Set Unit

This option selects the unit that will be active for location range, elevation and speed of the GPS feature.

- mile
- km

Note: This selection also changes the unit used for location range and speed.

Press [E / yes / gps] to accept the selection and return to the previous menu.

Set Serial Port

You can set the serial port speed from the following items.

- 4800 bps
- 9600 bps
- 19200 bps
- 38400 bps
- 57600 bps
- 115200 bps
- Off

Press [E / yes / gps] to accept the selection and return to the previous menu.

Band Defaults

This menu lets you set the default modulation and default step for each band.

The band settings are shown as menu items.

- 25.0:AM / 5.0
- 26.9:AM / 5.0
- 27.4:AM / 5.0
- 28.0:NFM/ 20.0
- 29.7:NFM/ 10.0
- 50.0:NFM/ 20.0
- 54.0:WFM/ 50.0
- 72.0:FM / 5.0
- 76.0:WFM/ 50.0
- 88.0:FMB/100.0
- 108.0:AM / 8.3
- 137.0:NFM/ 12.5
- 144.0:NFM/ 5.0
- 148.0:NFM/ 12.5
- 150.8:NFM/ 5.0
- 162.0:NFM/ 12.5
- 174.0:WFM/ 50.0
- 216.0:NFM/ 20.0
- 400.0:NFM/ 12.5
- 406.0:NFM/ 12.5
- 420.0:NFM/ 12.5
- 450.0:NFM/ 12.5
- 470.0:NFM/ 12.5
- 806.0:NFM/ 12.5
- 849.0:NFM/ 12.5
- 894.0:NFM/ 12.5
- 1240.0:NFM/ 25.0

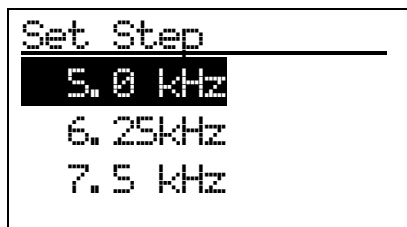
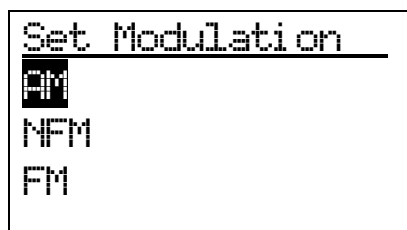
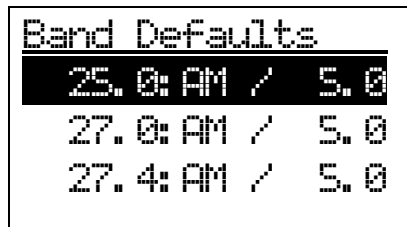

Turn [Scroll Control] to focus the cursor on the band you want to change. Then, press [E / yes / gps] to enter the modulation setting menu.

The following modulation setting values will be shown.

- AM set the current band as AM modulation
- NFM set the current band as NFM modulation
- FM set the current band as FM modulation
- WFM set the current band as WFM modulation
- FMB set the current band as FMB modulation

Turn [Scroll Control] to select the value, press [E / yes / gps] to set the selection and go to the Step Setting menu.

Selectable step values are:

- 5.0 kHz
- 6.25kHz
- 7.5kHz
- 8.33kHz
- 10.0 kHz
- 12.5 kHz
- 15.0 kHz
- 20.0 kHz
- 25.0 kHz
- 50.0 kHz
- 100.0 kHz

Turn [Scroll Control] to select the value, press [E / yes / gps] to set the selection and return to the Band Defaults setting menu.

See Scanner Info

This menu lets you see some information about the scanner, including the memory usage.

Select from the following items.

- % Memory Used
- Firmware Version

Press [E / yes / gps] to go to each setting.

% Memory Used

When you select this option, the scanner displays the percent of memory that is used, the number and percent of systems, sites and channels that are created.

This display is as follows.

Memory Used:	62%
SYSTEM 135:	27%
SITE 921:	92%
CHN 15758:	63%

The Value is displayed until you press any key and return to the previous menu.

Firmware Version

When you select this option, the scanner displays the firmware version as "Version #.#.#.#".

And the serial number of the unit is displayed as "SN#####"

Note : The serial number includes 14 digits.

Press any key to return to the previous menu.

SCAN MODE

Display during Scan Mode

The LCD display in Scan mode is as follows.

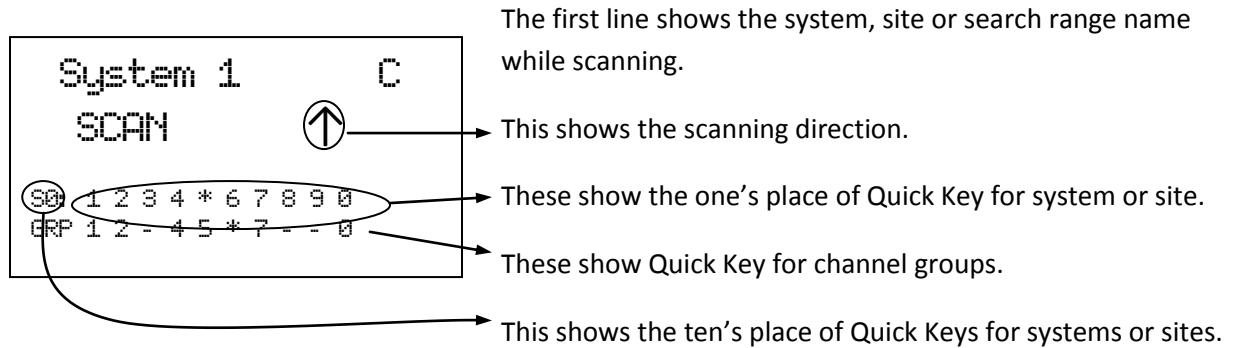

- SCAN : This scrolls to the left from the right while Scan Mode.
- S : This icon appears with icons of Quick Key numbers for Systems / Sites.
- GRP : This icon appears with icons of Quick Key number for Groups.

Startup Key Operation

The scanner can change the lockout state for each system or each site when you turn it on while pressing a number key.

First, you set the Startup Key for each system or each site.

You can set one key from 0 to 9 for each system or site.

If you hold a number key while turning on the scanner, it displays the following message after displaying the copyright message.

```
Startup Config.  
Key No. 1  
Processing  
Please Wait
```

Systems and Sites whose Startup Key matches the one you press are unlocked and systems and sites whose Startup Key do not match are locked out. Systems and Sites whose startup key are assigned "." are not affected (if they were locked or unlocked before, their lockout status does not change).

Quick keys for the matching systems and sites are also enabled.

Start Scanning

When you press [Scan / srch] to go to the Scan Mode the scanner scans all sites and systems that are not locked out and whose System/Site quick key is enabled. Then, the scanner scans all unlocked Service and Custom Search Ranges whose quick keys are enabled (Search with Scan). After Search with Scan, the scanner scans CC Hits System.

While in the Scan Mode, the first line displays currently scanned system, site or search range name and the second line displays "SCAN" (for conventional System) or "ID SCAN", "ID SEARCH" (for trunked System) scrolling from the right to the left, or a search frequency. Disabled Quick Keys are displayed as "*". The Quick Key for the Current System blinks.

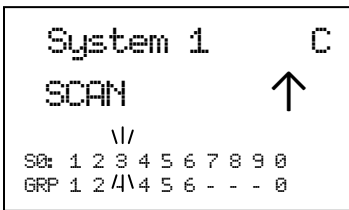

Scan for conventional system

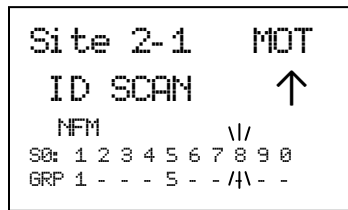

ID Scan for trunked system

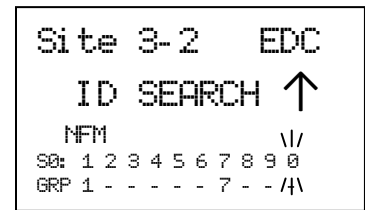

ID Search for trunked system

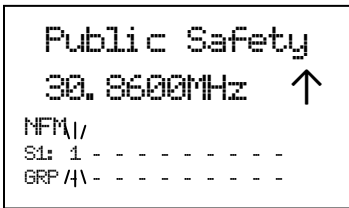

Service Search in Search with Scan

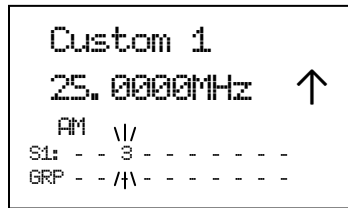

Custom Search in Search with Scan



Close Call Hits with Scan

When all channels are locked out directly or indirectly*, the scanner displays "Nothing to Scan" and the scanner stays in the Scan Mode.

*"A channel is locked out directly or indirectly" means:

1. The channel is locked out.
2. The group containing the Channel is locked out.
3. The Quick Key for groups to which that group belongs is disabled.
4. The system / site containing the channel is locked out.
5. The Quick Key for systems / sites to which that system belongs is disabled.

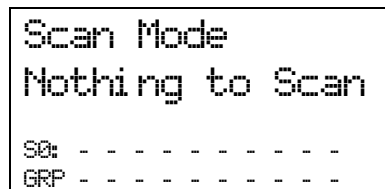

If the Channels are unlocked by cancellation of any of the above-mentioned states, the scanner will start scanning immediately.

Scanning Order

First, systems belonging to Quick Key 1 are scanned. Then systems that belong to Quick Key 2, ..., 9, 0, 11, ..., 19, 10, 21, ..., 99, 90 are scanned in order. Systems with no Quick Key are scanned last.

When the scanning of all systems ends, the scanner starts Service Search for any unlocked/enabled searches. The scanner searches Public Safety, News, . . . , and Special in turn.

When Service Search ends, it starts Custom Search. The scanner searches Custom Search from range 1 to 10 in turn.

After Custom Search ends, the scanner scans a system that is named "Close Call Hits*"

*This is a system where the scanner automatically stores the frequencies found by Close Call.

(See *CC Hit with Scan* for details.)

If "Close Call Hits" system has no frequencies, the scanner does not scan this system. After the scanner finishes scanning "Close Call Hits" system, the scanner scans from top system again.

You can change the scanning direction by turning [Scroll Control].

The scanning order of the systems / sites belonging to the same Quick Key is the order registered to that Quick Key. The scanning order of the systems / sites belonging to no Quick Key is the order set to none.

When a system / site is created, the scanner automatically sets the Quick Key to none. So, if you do not change the Quick Key setting, the scanning order will be the order of system / site creation.

The scanning order of groups in a conventional system also depends in the order set to any Group Quick Key or none. Groups with no Group Quick Key set are scanned in the order of group creation.

The scanning order of Channels in a conventional system's channel group depends in the order of Channel creation.

However, locked out or disabled items* are not scanned.

*Locked out or disabled items means locked out System / Sites, locked out Channel Groups, locked out Channels, disabled System/Site Quick Keys and disabled Group Quick Keys.

Scanning Operation

Quick Key Operation

For Conventional Systems, the SQK is set at the system level. However, for trunked systems, the SQK is set at the site level instead of the system level.

In the display, enabled SQKs show their number; disabled SQKs show "*"; SQKs with no system assigned show "-".

During scanning, you can enable or disable single digit SQKs by pressing the corresponding [1 - 9, 0] key.

For two-digit SQK's first press [./no/pri], then enter the two digits to enable or disable that SQK.

Systems belonging to disabled SQKs are not scanned.

*You cannot enable or disable an SQK if no system or site is assigned to it.

*The displayed GQKs (channel Group Quick Keys) show the status of GQKs for the system currently being scanned.

For example, the scanner displays as follows if the SQKs "3", "4", "6", and "9" are disabled.

```
System 1      C
SCAN         ↑
SQ: 1 2 * * 5 * 7 8 * 0
GRP 1 2 3 4 5 6 7 8 9 0
```

The details of scanning depend on whether the System is a conventional System or a trunked System.

The SQK's Ten's blinks when you press [./no/pri] (until you enter the SQK's first digit).

```
System 1      C
SCAN         ↑
SQ: 1 2 * * 5 * 7 8 * 0
GRP 1 2 3 4 5 6 7 8 9 0
```

If you do not press a digit within 2 seconds of pressing [./no/pri], the entry times out and nothing is changed.

Scan for Conventional Systems

In conventional scanning, the scanner steps through each unlocked channel. If there is activity on the channel, the scanner monitors activity until the transmission ends.

While monitoring the transmission, the first line alternates between the current system name and current group name every 1 second. The second line displays the current channel name.

The Quick Keys for the current system and channel group blink. Furthermore, the attenuation setting, modulation and CTCSS/DCS data of the current channel are displayed.

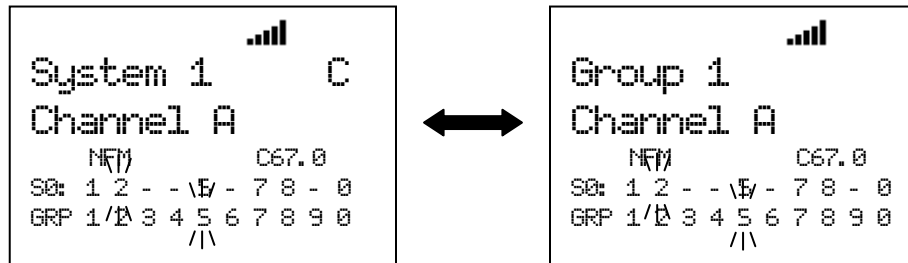

Even if the transmission ends, the scanner holds on the channel for the duration of the system delay time. After the system delay time elapses, if there is no transmission the scanner resumes scanning.

*If CTCSS/DCS is applied to a channel, the received signal must match for the scanner to hold on the transmission. (Not for AM, WFM or FMB modulation.)

The scanner continuously scans each system for the duration of the system's system hold time setting. However, the scanner scans all unlocked channels at least 1 time, even if this takes longer than the set time.

The scanner will advance to the next system once the scanner scans all unlocked channels and the system hold time has elapsed.

Scan for Trunked Systems

In trunked scanning, the scanner holds on the control channel (C-Ch) and decodes the TGIDs as they become active.

While scanning, press Function then [Scan / srch] to toggle between ID Scan and ID Search. You can also change this mode through the Menu. (See: [ID Scan/Search.](#))

ID Search :

If a TGID does not match any locked out TGID, the scanner goes to the V-Ch and monitors the transmission until it ends.

ID Scan :

If a TGID matches a TGID stored in an unlocked channel, the scanner goes to the V-Ch and monitors the transmission until it ends.

While monitoring a TGID already stored into the Memory, the first line of the display alternates between the current site name and current channel group name every 1 second, and second line displays the current channel name. The Quick Key numbers for the current site and group blinks.

While monitoring a TGID not stored into the Memory, the first line displays current site name, and the second line displays the current TGID. The current Site and Group Quick Keys blink.

While monitoring the TGID:

Press [Scan / srch] or turn [Scroll Control] to return to the C-Ch. Then the scanner waits for a moment on the C-Ch to see if another TGID is active. If the scanner finds another TGID, it monitors the found TGID. But if there is only the TGID that was being monitored just before, it monitors that TGID again.

Press [L/O] to lock out the TGID and store it to the list of ID Lockouts of the system (See: Clr All L/O IDs). This lock out information is common to every site in the system. Then the scanner returns to the C-Ch.

If the transmission ends, it returns to the C-Ch and exclusively listens for the last-active TGID until the site delay time expires.

After the system delay time elapses, the scanner checks to see if the Site Hold time has elapsed. If so, the scanner advances to the next System or Site. If the Site Hold Time has not elapsed, the scanner continues to monitor the C-Ch for TGID activity.

Lockout Operation

You can lock out each site but cannot lock out the system to which the site belongs.

In Trunked Systems (except EDACS SCAT system), one system can have multiple sites and those sites share the same TalkGroup IDs.

If you lock out a TGID, the TGID is locked out for all sites in the system.

ID Display Format

The scanner displays received ID in the following format on the second line.

Normal ID

The scanner displays as "ID:xxxx" for no-named TGID.

Example)	MOT Type I ID	:	ID:101-1	
	MOT Type II	:	ID:12345	(Decimal Format)
		:	ID:123 h	(Hexadecimal Format)
	EDACS	:	ID:01-023	(AFS Format)
		:	ID:147	(Decimal Format)
	LTR	:	ID:0-20-254	

I-Call

The scanner displays ID as "ID:xxxxxx" for no-named TGID. In order to show that ID is I-Call, "i" is displayed on the left end of the ID.

Example)	MOT Type I I-Call	:	ID:i12345	
	MOT Type II	:	ID:i12345	(Decimal Format)
		:	ID:i1234h	(Hexadecimal Format)
	EDACS I-Call	:	ID:i12345	

I-Call wild card (i0)

The scanner will display the received I-Call for wild card.

Example)	I-Call wild card	:	ID:i0	(while scanning)
			ID:i123456	(when it receives a ID)

MOT Individual Call

The scanner displays both IDs under communication as "ID:xxxxxx-yyyyyy".

In order to show that IDs are Individual Call, "i" is displayed on the left end of IDs.

Example)

	MOT Type I Individual Call	:	ID:i12345-i23456	
	MOT Type II	:	ID:i12345-i23456	(Decimal Format)
		:	ID:i1234h-i2345h	(Hexadecimal Format)

*If the left side ID is already named, the scanner only displays that ID's name.

PATCH ID

The scanner displays a PATCH list IDs and received PATCH ID as "ID:xx-xxx yy-yyy".

(xx-xxx : One of the PATCH list IDs, yy-yyy: received PATCH ID)

Example)	EDACS PATCH ID:	ID:01-012 00-002
	MOT Type II:	ID:42000 42016

*If the first PATCH list ID is already named, the scanner only displays that ID's name.

PARTIAL ID

The scanner displays the wild card portion of a PARTIAL ID as "-" in ID scanning.

When the scanner finds the ID that matches the PARTIAL ID, it displays the full received ID.

Example)	PARTIAL ID:	ID:01-01-	(while scanning)
		ID:01-015	(when it receives a ID)

Quick Save for ID Search

Press [E / yes / gps] to quickly store a TGID when the scanner stops on the TGID in ID Search.

The scanner prompts "Quick TGID Save?".

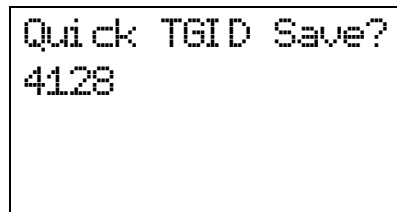

Quick TGID Save?
4128

Press [E / yes / gps] to store the TGID. The scanner creates a channel group named "Qck Save Grp" in the current system. The TalkGroup ID is stored in that channel group.

If you want to select another channel group to stores the TGID, press [./ no / pri]. Then select the group to store the channel into. The scanner stores it in the selected channel group.

Trunking Activity Indicators (Display Mode 3)

The scanner shows trunking activity when held on the C-Ch.

Press [6 / RIGHT / disp] in Function Mode to change the Display Mode in Scan Hold Mode. (See SCAN HOLD MODE.)

In EDACS and LTR systems, the order of indicators is the order of LCN.

In Motorola systems, it is the order of the frequency programming.

*This mode does not work for EDACS SCAT Systems.

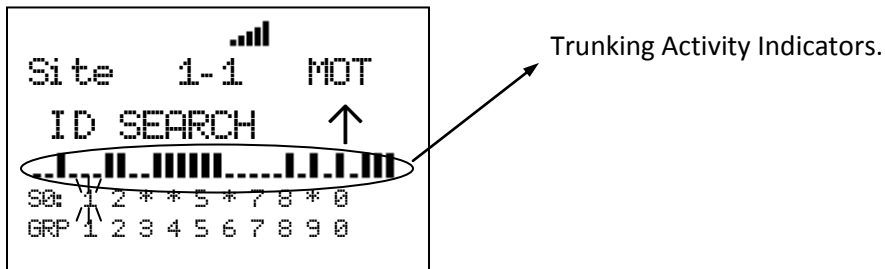

When the scanner receives a trunked system channel grant, the V-Ch blinks and the C-Ch lights. The scanner has 30 Channel Activity Indicators to visualize trunked system activity. This shows which site frequencies are in use.

The following figure shows that the scanner is staying on LCN1 and LCN3 and LCN4 are active.

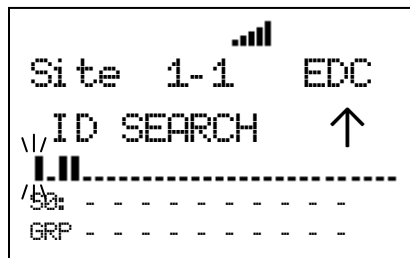

While the scanner is staying on a V-Ch, the voice channel blinks and its C-Ch turns on.

The following figure shows that the scanner is staying LCN3 and LCN1 is the control channel.

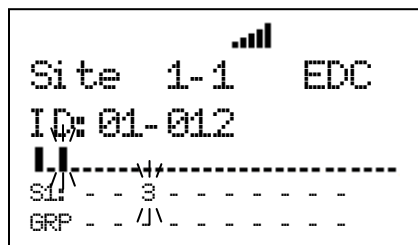

Location Based Scanning

This operation controls the lockout state for each group or site when the scanner is connected to a GPS unit.

This works automatically based on the location data from GPS when the feature is set to "On" in Set GPS Enable.

If the scanner goes within the location's range for a group or site, the scanner displays "Location Unlock" on the first line and the group name or the site name on second line.

```
GPS
Location Unlock
Site 1-1 MOT
SQ: - - - - -
GRP - - - - -
```

When the scanner goes outside the set range, the group or site is automatically temporarily locked out.

The scanner displays "Location L/O" on first line and the group name or the site name on second line.

```
GPS
Location L/O
Site 1-1 MOT
SQ: - - - - -
GRP - - - - -
```

This operation does not affect systems/sites whose SQK is disabled.

If a GPS is detected as soon as the scanner is turned on, the scanner displays "GPS CONNECTED" instead of displaying individual lock/unlock messages for groups and sites. It applies the location-based rules to all systems at one time.

```
GPS
GPS CONNECTED
SQ: - - - - -
GRP - - - - -
```

Control Channel Data Stream Output

The scanner can output the data stream on the control channel. You can turn on this feature in the menu Set C-CH Output. When it is active, the scanner will output the data stream whenever it is receiving a control channel. Also, for Motorola analog systems, the scanner will output the low speed data stream while receiving a voice channel.

Data Stream Output: ON

When data stream output is set to on, the scanner will output the data stream in the following format:
<Msg Type>,<CC data>.

Data Stream Output: Extend

When data stream output function is set to extend, the scanner will output the data stream in the following format: <Msg Type>,<CC data>,<decoded description>.

<Msg Type>=

ASCII character (3 chars):

MOT (Motorola)

EDW (EDACS Wide)

EDN (EDACS Narrow)

LTR

<CC data> =

OSW Data on Control Channel. It is deferent each Trunk System Type.

[MOT System]

MOT,<cmd>,<prv>,<id>

<cmd> = command or LCN (Hex 3 digits, 10 bits)

<prv> = private bit (1 bit)

<id> = ID (Hex 4 digit, 16 bits)

For example:

MOT,15C,0,D110

[ED Wide/Narrow]

EDW,,<cc>,<pppppp>

 = block number in a OSW (0 or 1)

<cc> = command (Hex 2 digits, 6 bits)

<pppppp> = message (Hex 6 digits, 22 bits)

For example:

EDW,0,3B,238333

EDN,0,3B,238333

Note: For EDACS narrow systems, the indicator will change from EDW to EDN.

[LTR System]

LTR,<A>-<GG>-<HH>-<III>-<FF>

<A> = Area Number (0 or 1)

<GG> = Goto Repeater Number (Hex 2 digits, 5 bits)

<HH> = Home Repeater Number (Hex 2 digits, 5 bits)

<III> = ID Number (Hex 2 digits, 8 bits)

<FF> = Free Repeater Number (Hex 2 digits, 5 bits)

For example:

LTR,0-01-01-FA-02

[MOT Subaudio]

MOT,<id>

<id> = ID (Hex 4 digit, 16 bits)

For example:

MOT,D110

<decoded description>

For Motorola system:

Decoded Description	Remark
,CNM TG-tttt CH-ccc VC-ffffff	Call for Talk Group tttt = Talk Group ID (Hex 4 digits, 16 bits) ccc = LCN (Hex 3 digits, 10 bits) ffffff = Frequency (BCD 8 digits)
,CIP TG-tttt CH-ccc VC-ffffff	Call for ICALL tttt = Talk Group ID (Hex 4 digits, 16 bits) ccc = LCN (Hex 3 digits, 10 bits) ffffff = Frequency (BCD 8 digits)
,CIV TG-tttt TGR-dddd CH-ccc VC-ffffff	Call for ICALL (Individual Call) tttt = Talk Group ID (Hex 4 digits, 16 bits) dddd = Talk Group ID for Receiver (Hex 4 digits, 16 bits) ccc = LCN (Hex 3 digits, 10 bits) ffffff = Frequency (BCD 8 digits)
,CPT TG-tttt CH-ccc VC-ffffff	Call for Patch/Multiselect tttt = Talk Group ID (Hex 4 digits, 16 bits) ccc = LCN (Hex 3 digits, 10 bits) ffffff = Frequency (BCD 8 digits)
,EVM	Event Command for Multiple OSW
,SID-ssss	System ID ssss = System ID (Hex 4 digits)
,PAT-pppp MEM-mmmm	Patch List Update pppp = Patch/Multiselect ID (Hex 4 digits, 16 bits) mmmm = Member ID (Hex 4 digits)
,SIT-nn	Site Number nn = Site Number (Hex 2 digits, 6 bits)
,CCH CH-ccc CC-ffffff	Control Channel ccc = LCN (Hex 3 digits, 10 bits) ffffff = Frequency (BCD 8 digits)

For EDACS system:

Decoded Description	Remark
,CNM TG-ttt CH-cc VC-ffffff	Call for Talk Group ttt = Talk Group ID (Hex 3 digits, 11 bits) cc = LCN (Hex 2 digits, 5 bits) ffffff = frequency (BCD 8 digits)
,CIP TG-tttt CH-cc VC-ffffff	Call for ICALL tttt = Unit ID (Hex 4 digits, 14 bits) cc = LCN (Hex 2 digits, 5 bits) ffffff = frequency (BCD 8 digits)
,CPT TG-ttt CH-cc VC-ffffff	Call for Patch tttt = Patch ID (Hex 3 digits, 11 bits) cc = LCN (Hex 2 digits, 5 bits) ffffff = frequency (BCD 8 digits)
,PAT-ppp MEM-mmm	Patch List Update ppp = Patch ID (Hex 3 digits, 11 bits) mmm = Member ID (Hex 3 digits, 11 bits)
,SIT-ss	Site ID ss = Site ID (Hex 2 digits, 6 bits)

For LTR system:

Decoded Description	Remark
,CAL TG-a-hh-dd Free-ee CH-gg VC-ffffff	Call for Talk Group a = Area (Hex 1 digits, 1 bit) hh = Home Ch (Hex 2 digits, 5 bits) dd = ID (Hex 2 digits, 8 bits) ee = Free Ch (Hex 2 digits, 5 bits) gg = Goto Ch (Hex 2 digits, 5 bits) ffffff = Frequency (BCD 8 digits)
,DIS TG-a-hh-dd Free-ee	Disconnect Code a = Area (Hex 1 digits, 1 bit) hh = Home Ch (Hex 2 digits, 5 bits) dd = ID (Hex 2 digits, 8 bits) ee = Free Ch (Hex 2 digits, 5 bits)

Temporary System Hold

*For trunked systems, “system” should be read as “site” in this section.

**In Temporary System Hold state, Priority Scan and Close Call function are not performed.

The scanner scans only one system while displaying **F** icon by pressing [FUNC] Key. This state is called "Temporary System Hold".

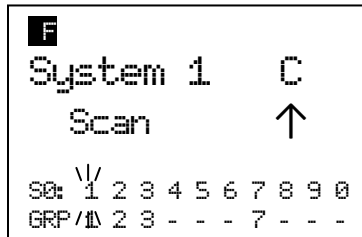

In this state, press [L/O] once to temporarily lock out a current system with “Temporary L/O” message.

Press [L/O] twice within one second to permanently lock out the current system with “Locked out” message.

Long press this key to display the prompt “Unlock All Systems?” for unlocking all systems, sites, search ranges and Close Call Hits system and enable all Quick Keys for all system/site.

Press [E / yes / gps] to unlock all data. Then scanner displays “All Systems” and “Unlocked”.

Press [. / no / pri] to return to the previous mode without unlocking.

In a trunked system, press [Scan / srch] key in Function Mode to change ID Search and ID Scan for the system.

When you select a system while the scanner is Temporary System Hold without a timeout, the scanner scans only the selected system.

If the selected system is locked out, it is automatically unlocks and scans the system. Other lockout states* are not unlocked.

When it cannot scan the selected system, the scanner displays the system name on the first line and “Nothing to Scan” on the second line.

The scanner displays this message until you press any key. Then the scanner exits Temporary System Hold Mode and starts scanning.

**“Other lockout states” means the following. The scanner displays “Nothing to Scan”.

- Quick Key for the selected system is disabled.
- All channel groups for the selected system are locked out.
- Quick key for all channel groups are disabled off.
- All channels for the selected system are locked out.

System Hold

Long press [Hold / ] to goes to the System Hold Mode.

While on System Hold, the scanner scans only one system and the scanner flashes the HOLD icon.

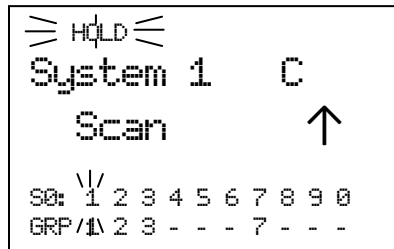

Long press [Hold / ] key to resume full system scan, and other keys will work normally.

If the selected system can't be scanned, the scanner can't go to System Hold Mode.

Quick System Select

*In trunked system, the "system" means "site" for this section.

*In Quick System Select state, Priority Scan and Close Call function are not performed.

Turn [Scroll Control] knob in Function Mode to select a System. While selecting systems, scanning is not performed.

You can select from all Systems that have 1 or more Channels. Locked out Systems and Systems belonging to disabled SQKs also appears in this selection.

Press [E / yes / gps] or the [Scroll Control] to select a system and return to the previous mode.

Press [L/O] in Function Mode to toggle lockout state for the selected system.

Press [1 - 9, 0] in Function Mode to enable or disable GQKs for the selected System.

Quick System Select Resume

Pressing [FUNC] or [E / yes / gps] or pressing the [Scroll Control] resumes scanning immediately from the selected system even if the system is locked out (it is force to be unlocked). The scanner also resumes scanning when a timeout happens.

The temporary system hold status continues after system selection.

If the scanner has no channels to scan (as listed below) in the selected system, it displays "Nothing to Scan".

- SQK for the selected system is disabled.
- All channel groups for the selected system are locked out.
- GQK for all channel groups are disabled.
- All channels for the selected system are locked out.

The scanner resumes scanning from the next system when you press any key.

System Select in Scan Hold Mode

When you go to Quick Select System from Scan Hold Mode and exit from this state, the scanner holds on the first channel of the selected system.

If you select a locked out system, the locked state for the selected system is not changed.

Quick Save for CTCSS/DCS Data

When CTCSS/DCS search is set for a conventional channel and the scanner is detecting a CTCSS/DCS tone data, you can store the tone data into the current channel by pressing [E / yes / gps]. The scanner prompts "Set Found CTCSS/DCS?" and "Yes="E" / No="."."

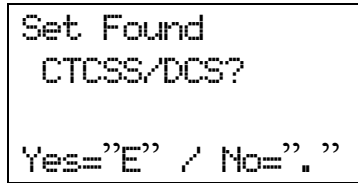

```
Set Found
CTCSS/DCS?

Yes="E" / No="."
```

Press [E / yes / gps] to store the tone data and go to the editing menu for the current channel.

Press [. / no / pri] to go to the editing menu for the current channel without storing it.

Press [Scan / srch] or [Hold / 

Press [L/O] or [MENU] to cancel the prompt and returns to the previous mode.

Key Operation During Scan

Normal Mode

[Scroll Control] knob

Turn this knob to resume scanning while monitoring.

Turn this knob to change the scan direction. If the scanner is scanning system scan, service search, then custom search turn this knob counterclockwise to scan custom search, service search, then system scan.

[Scan / srch] key

Press this key to resume scanning while monitoring.

[Hold /] key

Press this key to go to Scan Hold Mode.

Long press this key for System Hold Mode.

In System Hold Mode, long press this key for full system scan.

[L/O] key

Press this key once to temporarily lock out the monitored channel or TGID (in ID Search Mode). When the scanner is turned off, the channel or TGID is unlocked.

Press this key twice within one second to lockout the monitored channel or TGID (in ID Search Mode). When the scanner is turned off, these lockouts remain.

Long press this key to unlock all channels and TGIDs in the current system when the scanner is receiving a signal.

[1 - 9, 0] key

Press these keys to enable or disable SQKs.

[. / no / pri] key

Press this key to go to the mode that selects the ten's place for SQKs, then press the number key to jump to the ten's place.

[E / yes / gps] key

Press this key to edit the data for the current channel.

If the current system is a protected system, the scanner displays the "Protected System Access Not Allowed Press Any Key" and sound an error tone.

[MENU] key

Press this key to go to the Menu Mode at Top Menu.

Function Mode

F+[Scroll Control] knob

Turn this knob to select a system quickly. The scanner will start scanning from the selected system.

F+[Scan / srch] key

If the current system is a conventional system or search range:

- Press this key to display the prompt for starting Quick Search.
- Press [E / yes / gps] to start Quick Search.
- Press [. / no / pri] to go to Search for...
- Press [L/O] to cancel the prompt.
- Press [Hold / 

If the current system is a trunked system:

- Press this key to switch between ID Search and ID Scan.

F+[Hold /

Press this key to toggle Close Call functions.

Long press this key to start Close Call Only Mode.

F+[L/O] key

Press this key once to temporarily lock out a system, site, or a search range. When the scanner is turned off, this is unlocked.

Press this key twice in a second to lockout a system, site or a search range. When the scanner is turned off, these lockouts remain.

Long press this key to display the prompt “Unlock All Systems?” to unlock all systems, sites, search ranges and Close Call Hits system and enable all Quick Keys for all systems/sites.

Press [E / yes / gps] to unlock all data.

Press [. / no / pri] to return to the previous mode without unlocking.

F+[1 - 9, 0] key

Press this key to enable or disable GQKs for the current system.

F+[. / no / pri] key

Press this key to toggle Priority Mode for conventional priority.

F+[E / yes / gps] key

Press this key to change to the GPS Mode.

Long press this key to store the current location. Then the scanner prompts you to select the location type.

F+[MENU] key

Press this key to go to the editing menu for the current system or current search range.

If the current system is a protected system, the scanner displays the “Protected System Access Not Allowed Press Any Key” and sounds an error tone.

SCAN HOLD MODE



Press [Hold / 

Display while in Scan Hold Mode

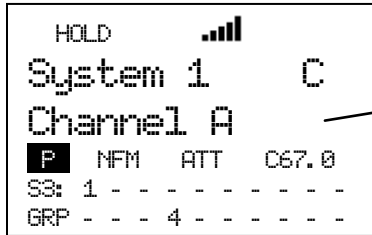
The display in Scan Hold mode is as follows.



This shows a channel name or a frequency.

C67.0	:	This appears when the channel has a CTCSS or DCS. In CTCSS/DCS Search Mode, if this is hit, the value blinks. If CTCSS/DCS is set to lockout, the display alternates between the CTCSS/DCS data and "*****".
HOLD	:	This icon appears while in Scan Hold Mode.
	:	This icon shows the strength of the signal from 0 to 5.
	:	This icon appears if the channel is set to "Priority On".
NFM	:	These icons show the modulation type.
ATT	:	This icon appears when the channel is set to "Attenuator On".
SQ:	:	This icon appears with icons of the SQK (from "0" to "99"). x shows the current ten's place for the SQK.
GRP	:	This icon appears with icons of the GQK (1 - 9,0).

General Operation

Turn [Scroll Control] to select the channel, trunk frequency, TGID or search frequency.

Hold on a Channel in Conventional System:

The scanner alternately displays the system and channel group name on the first line and it displays the channel on the second line. The SQK and GQK for the channel is displayed. The scanner continuously monitors the selected channel.

While holding on a channel, the scanner changes the display for the system name and channel group name every second.

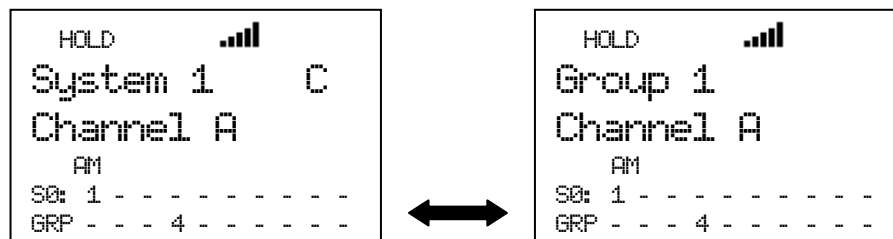

Press [E / yes / gps] to go to the editing menu of channel you are holding on at Channel Settings.

Press [FUNC] to go to the Function Mode and display the system number tag, channel number tag, IF Exchange and Volume level.

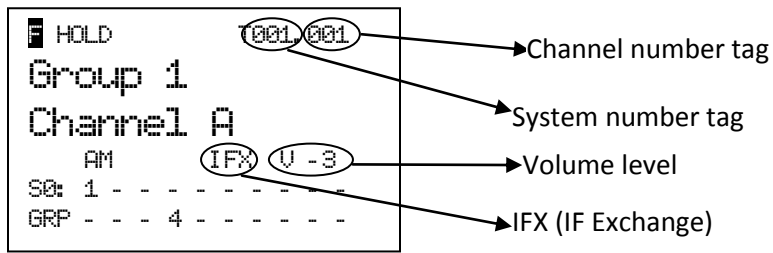

Press [6 / RIGHT / disp] in Function Mode to change the Display Mode.

The scanner displays the channel name on the second line.

In Display Mode 2, the scanner displays the current channel frequency under the channel name instead of the priority channel icon, modulation icon, and attenuator.

In Display Mode 3, since the scanner can't display the Trunking Activity Indicators for a conventional system, it displays just like Mode 1 for conventional.

For example, the scanner displays as follows when the channel name for "162.4000MHz" is "Channel A".

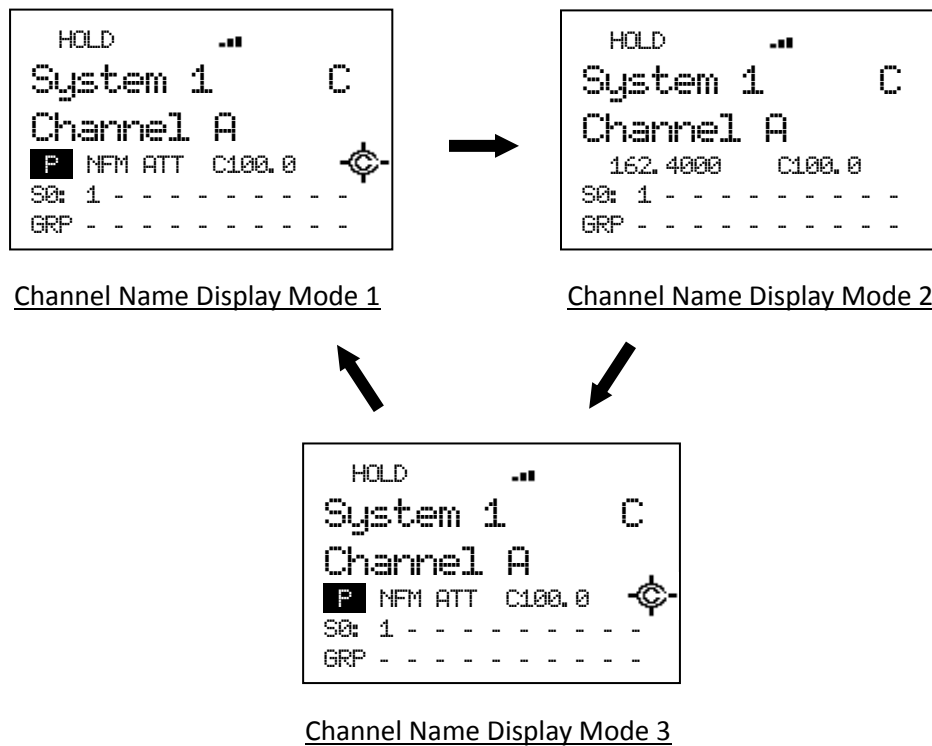

In Display Mode 2, even if the Close Call setting is "CC Pri" or "CC DND", the Close Call icon is not displayed when CTCSS/DCS setting is set or tone data has been detected in CTCSS/DCS Search mode.

Hold on a Channel (TGID) in Trunked System:

*If there are two or more sites in the system, the same TGIDs will appear in every site. The scanner checks the current site for the selected TGID.

When you hold on a channel in a trunked system and a C-Ch exists, the scanner displays as follows.

If the TGID you are holding on is stored into the system, first line alternately displays the site name and channel group name. The second line displays the TGID Name. The V-Ch frequency is displayed under the TGID display.

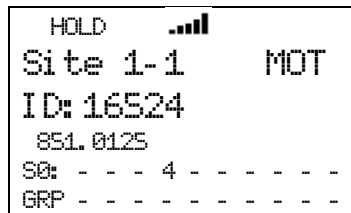

Press [6 / RIGHT / disp] in Function Mode to change the Display Mode.

In Display Mode 1, the scanner displays the TGID name on the second line and the V-Ch frequency under the second line.

In Display mode 2, the scanner displays the TGID name on the second line and TGID under the second line.

In Display mode 3, the scanner displays the TGID name on the second line and trunking activity indicators under the second line.

For example, the V-ch frequency is “851.0250MHz” and the channel name of “ID:16512” is "Police".

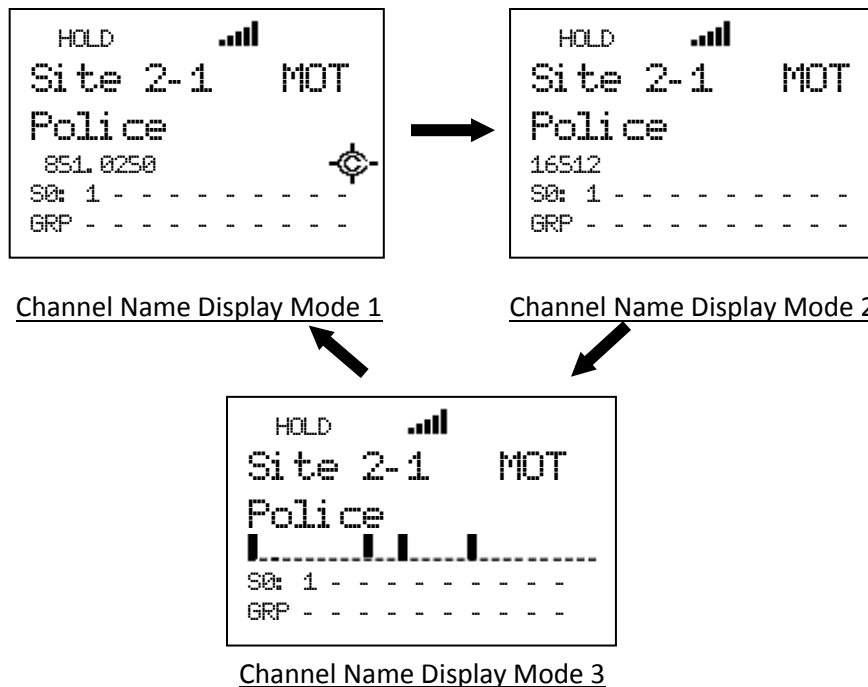

In Channel Name Display Mode 2 and 3, even if the Close Call setting is “CC Pri” or “CC DND”, the Close Call icon is not displayed.

For example, "ID:0-01-063" for the LTR System displays in Channel Name Display Mode 2.

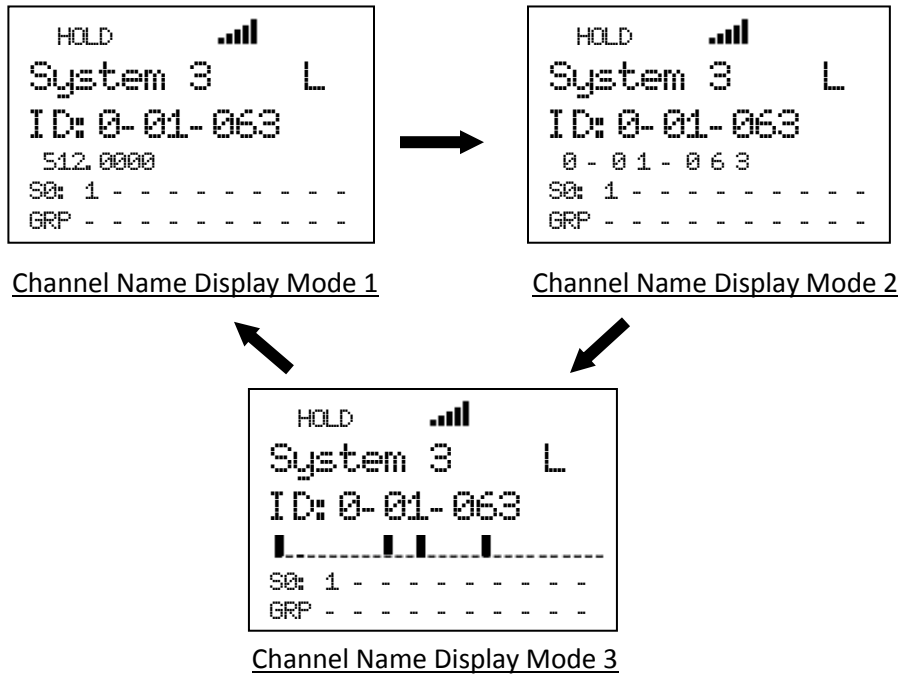

Hold on System Frequency:

The scanner displays the system name and System ID on the first line. It displays the trunk frequency on the second line.

For example, if 935.0125 MHz in "Site 3-1 MOT" belonging to Quick Key 1 is selected, the scanner displays:

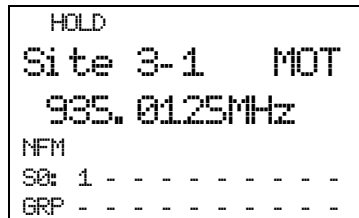

Press [E / yes / gps] to go to the System Editing menu at System Settings.

When the scanner receives a TGID, it displays the received TGID on the second line. If the TGID is already stored into the system and it is named, the channel name is displayed instead of the TGID. The holding trunked frequency is displayed under the TGID display.

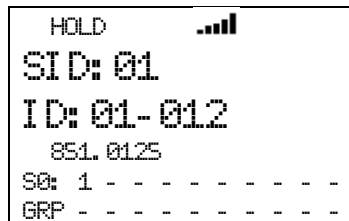

*In Motorola System, System ID is displayed as "SID:xxxxh-yyzz".

"xxxxh" means System ID. "yy" means Sub System ID. This is always is 00 for Motorola analog systems. "zz" means SITE ID.

For a system other than an EDACS SCAT System, the scanner monitors the received signal on the C-Ch or V-Ch.

*For EDACS SCAT Systems, the scanner only monitors Voice Data. It always displays system name on the first line and the trunk frequency on the second line.

Hold on Search Frequency:

The scanner displays the Search Range Name on the first line and the held frequency on the second line.



Press [E / yes / gps] to go to Quick Save Mode.

Hold on Conventional System

Turn [Scroll Control] clockwise to select the next channel.

Turn [Scroll Control] counterclockwise to select the previous channel.

If you turn [Scroll Control] clockwise when the scanner is on the last channel in the system, the scanner goes to the next system. If you turn [Scroll Control] counterclockwise when the scanner is on the first channel in the system, it goes to the previous system.

Hold on Trunked System

Turn [Scroll Control] to select the site frequency and channel (TGID).

Turn [Scroll Control] clockwise to select the next system frequency or channel and turn [Scroll Control] counterclockwise to select previous one.

If you turn [Scroll Control] clockwise when the scanner is on the last site frequency, it goes to the first channel in the System. If you turn [Scroll Control] clockwise when the scanner is on the last channel, it goes to the next system or site.

Turning [Scroll Control] counterclockwise on the first channel goes to the last site frequency. And turning [Scroll Control] counterclockwise on the first site frequency goes to the previous system or site.

When the scanner holds on a site frequency, the scanner displays the received TGID. It does not go to any voice channel. And you cannot lock out the displayed TGID.

Hold on TalkGroup ID from ID Search / ID Scan

The scanner monitors the held TGID continuously.

While monitoring a TGID already stored into Memory, the first line displays alternates between the current site name and the current group name, and the second line displays the current channel name. Also, the SQK and GQK numbers for the current monitoring site and channel group appears.

While monitoring an TGID not stored into Memory, the first line displays the current site name and the second line displays the monitored TGID. Also the SQK number for current Site appears.

Press [Scan / srch] or [Hold / 

Direct Entry

*The scanner receives nothing in this mode.

You can quickly store a frequency or a TGID using [0 - 9] and [. / no / pri].

You can also direct access channels that have channel number tags assigned.

Store Frequency

*You cannot use this function to store a frequency for a trunked System.

To quickly store a frequency into a channel for a conventional system, enter the frequency including the decimal point using the keypad, then press [E / yes / gps]. The scanner prompts "Quick Freq Save?".

*If you press [Hold / Go to Quick Search Hold Directly)



```
Quick Freq Save?  
25.0000MHz
```

If you press [E / yes / gps], the scanner creates a system named "Qck Save Cnv Sys" and creates a group named "Qck Save Grp" in the System. The scanner stores the entered frequency. If the scanner already the system and the group, the frequency is stored into the group.

If you press [. / no / pri], you can select a conventional system and the channel group for the frequency. The scanner displays only conventional systems that already exists. Next, the scanner displays channel groups and lets you select the channel group to store the entered frequency into.

Store TGID

To quickly store a TGID into a channel, enter the TGID using the number and decimal keys. Press the decimal key twice to enter a hyphen. If you press the decimal key first or at the left end, it will be entered as "i" for I-Call ID. Then press [E / yes / gps] and the scanner prompts "Quick TGID Save?".



Quick TGID Save?
4128

If you press [Hold / 

If you press [E / yes / gps], the scanner creates "Qck Save Grp" in the current system and stores this TGID there.

If you press [. / no / pri], the scanner prompts you to select a system to store this TGID.

Select the system* and the channel group, then the TGID is stored.

*In system selection, the scanner displays only the systems whose TGID format matches the TGID you entered. The ID format and system type relation are the following.

Input TGID (n: number)	System Type
nnn-nn nnnn-n n- nnn- nnnn- nnn-n nnnn innnnn	Motorola Systems (Type I, Type II)
nn-nnn nn- nn-nn- innnnn	EDACS Systems *Only AFS Format is allowed for Direct Entry except for I-Call ID.
n-nn-nnn n-nn-	LTR Systems

*For details of TGIDs, please see: [TGID FORMAT FOR TRUNKED SYSTEM.](#)

Once saved, the scanner allows you to change the Channel settings at menu location [Channel Settings.](#) Press [HOLD / 

Direct Access

Use this feature to quickly access a channel with number tags. System or channel number tags can be set in the menu. However if you set a channel number tag that already exists in the same system, or if you set a system tag that already exists in another system (include scan systems, service search with scan systems, custom search with scan systems, CC Hits with scan systems), a warning message will be displayed “No.Tag Exists Accept? (Y/N)”. Press [E / yes / gps] to set the same number tag, or press [/ no / pri] to input a new number tag.

To jump to a tagged channel from HOLD mode, enter the system number tag followed by a decimal point then the channel’s number tag, then press [MENU]. The scanner goes to Scan Hold Mode at the entered number tag.

For example, if you want to select Channel E from the below example, press [7][.][5][Menu].

System A (Number tag = 1)	Channel A (Number tag = 1)
	Channel B (Number tag = 5)
	Channel C (Number tag = 100)

System B (Number tag = 7)	Channel D (Number tag = 10)
	Channel E (Number tag = 5)
	Channel F (Number tag = 3)

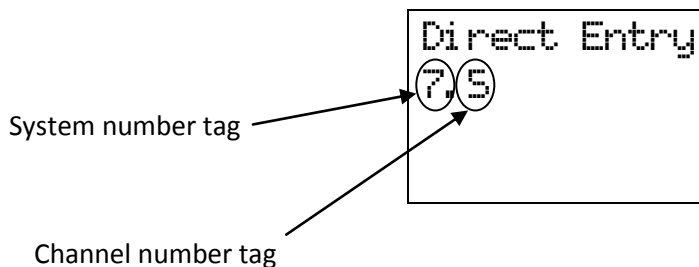

You do not have to enter the system number tag to select a channel in the current system.

When the scanner is holding on one of System A’s channels, press [1][0][0][Menu] to select Channel C.

If you press only system number tag with a dot, the scanner select the first channel of the system. Pressing [7][.][Menu], Channel D is selected. If no such system number tag exists, the scanner displays “SYS Number Tag XXX. is not Stored Press Any Key” and sounds an error tone.

If you enter an illegal channel number tag, the scanner displays “CH Number Tag XXX.XXX is not Stored Press Any Key” and sounds an error tone.

Key Operation During Scan Hold Mode

Normal Mode

[Scroll Control] knob

Turn this knob to select the channel.

[Scan / srch] key

Press this key to resume scanning.

[Hold /] key

Press this key to resume scanning.

Long press this key to activate System Hold Mode and resume scanning.

[L/O] key

Press this key once to temporarily lock out the held frequency or TGID. When the scanner is turned off, this is unlocked.

Press this key twice in a second to lock out the held frequency or TGID. When the scanner is turned off, this remains locked.

Long press this key to unlock all channels in the current system (for conventional systems).

Long press this key to unlock all frequencies of the site and all TGIDs of the current system (for trunked system / sites).

[1 - 9, 0] key

Press this key to enter numbers and go to Direct Entry.

[. / no / pri] key

Press this key to input decimal point, hyphen or “i” for Direct Entry.

[E / yes / gps] key

Press this key to edit the data for the current channel.

Press this key to edit the system when the scanner is held on a trunked frequency.

If the current system is protected system, the scanner displays “Protected System Access Not Allowed Press Any Key” and sound an error tone.

[MENU] key

Press this key to go to the Menu Mode at Top Menu.

Press this key to use Direct Access in Direct entry mode.

[FUNC] key

Press this key to go to Function Mode with a 3-second timeout. The scanner displays the system number tag and channel number tag. If you do not press a key within 3 seconds, function mode is automatically cancelled.

Long press this key to go to Function Mode without a timeout.

Function Mode



[Scroll Control] knob

Turn this knob to quickly select a system.

[Scan / srch] key

Press this key to display the prompt for starting Quick Search.

If the current system is a conventional system or search range:

- Press [E / yes / gps] to start Quick Search.
- Press [. / no / pri] to go to Search for...
- Press [L/O] to cancel this prompt.
- Press [Hold / - If the current system is a trunked system:
 - Press [E / yes / gps] to start ID Search.
 - Press [. / no / pri] to go to Search for...
 - Press [L/O] to cancel this prompt.
 - Press [Hold / 

[Hold /

Press this key to toggle Close Call functions.

Long press this key to start Close Call Only Mode.

[L/O] key

Press this key once to temporarily lock out a system or a search range. When the scanner is turned off, this is unlocked.

Press this key twice in a second to lockout a system or a search range. When the scanner is turned off, this remains locked out.

Long press this key to turn on all Quick Key settings for systems / Sites, and unlock all systems and search ranges.

Long press this key to display the prompt “Unlock All Systems?” for unlocking all systems, sites, search ranges and Close Call Hits system and enable all Quick Keys for all system/sites.

Press [E / yes / gps] to unlock all data.

Press [. / no / pri] to return to the previous mode without unlocking.

[1-3 / sr1-3] key

Press this key to start searching the search range set at Set Search Key.

[4 / LEFT / ifx] key

Press this key to exchange the IF(intermediate frequency) for receiving radio signals to avoid interference.

[5 / lvl] key

Press this key to change the volume offset level.

[6 / RIGHT / disp] key

Press this key to change the Display Mode.

(Display mode 1 -> Display mode 2 -> Display mode 3 -> Display mode 1 ->....)

[7 / att] key

Press this key to toggle the attenuator setting.

Long press this key to toggle the global attenuator setting.

[8 / rev] key

Long press this key to show the reverse frequency for the current frequency.

And release this key to return to the current frequency.

[9 / mod] key

Press this key to toggle the modulation state for global setting.

[0 / wx] key

Press this key to change WX Alert Priority Mode.

Long press this key to start WX Scan.

[. / no / pri] key

Press this key to toggle Priority Mode for conventional priority.

[E / yes / gps] key

Press this key to change to the GPS Mode.

[MENU] key

Press this key to go to the editing menu for the current system or current search range.

If the current system is a protected system, the scanner displays "Protected System Access Not Allowed Press Any Key" and sound an error tone.

PRIORITY SCAN

There are two kinds of Priority Scan. (See: [Set Priority](#))

Refer to [Set Priority](#) for setting Priority Channels.

Priority Scan

This works in Scan Mode or Scan Hold Mode when the Priority Scan setting is on. In this condition, "PRI" icon appears.

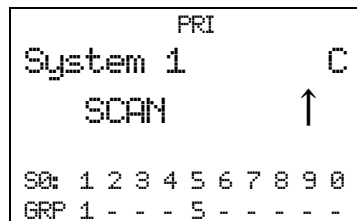

When the scanner is scanning a conventional system, it interrupts every 2 seconds to check Priority Channels (P-Ch) of all unlocked conventional Systems for activity. If there are many P-Chs, Priority Scan interrupts normal scanning for a long time.

Although any conventional frequency can be set as a priority channel, the scanner is unable to scan over 100 channels at once. If there are more than 100 unlocked priority channels, the first 100 channels will be scanned for priority scanning but others won't.

The priority for P-Channels is determined by System and Group Quick Key settings.

The highest priority is for P-Channels to which the SQK and GQK are "1". And the lowest priority is for P-Channels to which the SQK is "90" and GQK is "0".

Priority for P-Channels in the same channel group follows the order in which the channels were created.

If there are no Priority Channels or all Priority Channels are locked out, the scanner displays "Priority Scan No Channel" and sounds an Error Tone. The scanner cannot work the Priority Scan. The scanner restarts normal scanning when you press any key. Priority Scan is set to off automatically.

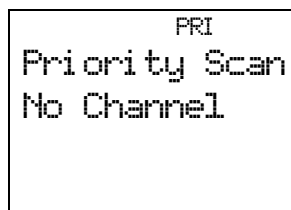

Priority Plus Scan

This works in Scan Mode or Scan Hold Mode when the setting of Priority Scan is Plus On. In this condition, the "PRI" icon blinks and the scanner scans only Priority Channels.

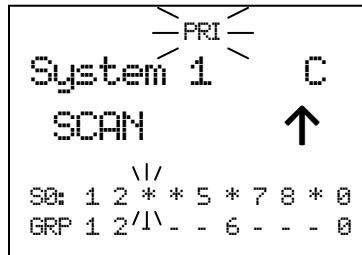

If there is no Priority Channel or all Priority Channels are locked out, the scanner displays "Priority Scan No Channel" and sounds an Error Tone. Then Priority Plus Scan stops.

Press any key to cancel it. Priority Scan is turned off automatically and it starts normal scanning.

Key Operation During Priority Scan

Key operations are the same as in Scan Mode and Scan Hold Mode.

See: [Key Operation During Scan](#) and [Key Operation During Scan Hold Mode](#).

PRIORITY ID SCAN

Refer to [Set Priority](#) to set Priority Channels. Refer to [Priority ID Scan](#) for activation of Priority ID Scan.

Priority ID Scan

Priority ID Scan works in ID Scan/Search Mode or ID Scan/Search Hold Mode when the Priority ID Scan setting is on.

This works on Motorola and EDACS (Wide, Narrow), and LTR Systems.

This function is very similar to conventional priority although there is no “interrupt” during the transmission. Priorities are checked in between transmissions, when the scanner is receiving the control channel, as during the channel delay period.

Motorola system can receive priority IDs while the scanner is on the voice channel. However, for this to work, the channel must also be assigned as a priority channel by the radio system (otherwise, the TGID will never be sent on the voice channel’s low-speed data).

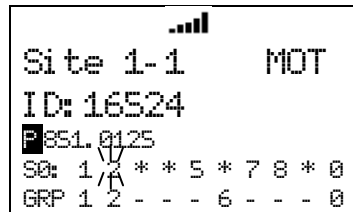

A screenshot of a scanner's LCD display. The display shows the following text: "Site 1-1 MOT", "ID: 16524", "P 851.0125", "SQ: 1 2 * * 5 * 7 8 * 0", and "GRP 1 2 - - - 6 - - - 0". There are also some small graphical icons at the top right of the display area.

The scanner can only look for priority channels on the trunked system it is currently scanning and only responds if the priority channel is unlocked..

The within the system, channels in channel groups with GQK 1 are treated with highest priority, followed by 2, 3, ... 9, 0.

Key Operation During Priority ID Scan

Key operations are same as in ID Scan Mode and ID Scan Hold Mode.

See: [Key Operation During Scan](#) and [Key Operation During Scan Hold Mode](#).

SEARCH MODE

The scanner has Service Search, Custom Search and Quick Search in Search Mode.

Display during Search Mode

The LCD display in Search mode is as follows.

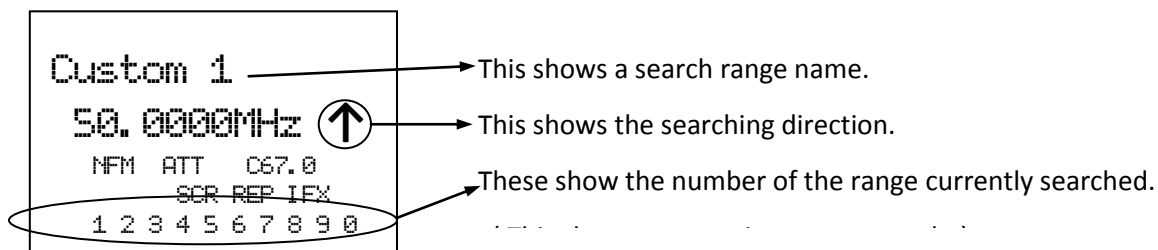

- NFM : These icons show the modulation type.
- ATT : This icon appears when the attenuator for a range or global attenuator is On.
- C67.0 : The scanner displays the data of CTCSS/DCS in the location here.
- SCR : This icon appears when one or more Broadcast Screen is set to On.
- REP : This icon appears when the Repeater Find function is On.
- IFX : This icon appears on frequency that have IF exchange On.

General Operation

While searching, frequencies are displayed in order, and the searching direction is also displayed on right end.

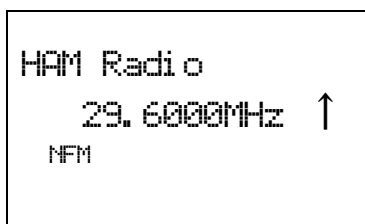

While searching, locked out frequencies are skipped. The lockout information is common to all Searches and Close Call. You can confirm or unlock these locked out frequencies at [Freq Lockouts](#).

Press [Hold / 

If CTCSS/DCS Search is On (See: [Tone/Code Search](#)), the scanner searches for any active CTCSS/DCS on the frequency. (Not for the AM, FMB and WFM modulation.)

For example, if it stops on 152.8700MHz in News and finds CTCSS is 67.0 Hz, the scanner displays as follows.

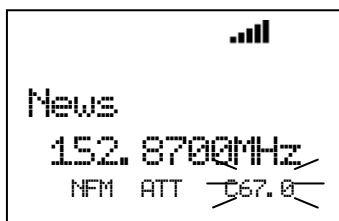

If the scanner finds DCS 023, the scanner would display “DCS023” instead of “C67.0”.

Service Search

You can search one of the pre-programmed search ranges.

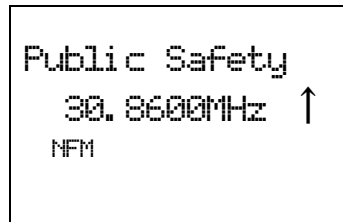

The Scanner starts from the lowest frequency of the selected range and searches in ascending or descending order. While searching, turn [Scroll Control] to change the searching direction.

If the scanner finds a transmission, it stops on the frequency and the second line displays the frequency and the unit "MHz". The scanner displays a signal meter that shows a signal level. (1 – 5)

For example, if it stops on 30.9000 MHz in Public Safety, the scanner displays as follows.



If the search range is one that includes channel numbers (like CB or Marine), the scanner displays the frequency and the channel number. The frequency unit is not displayed.

For example, if it stops on 27.4050 MHz of CB Radio, the scanner displays as follows.

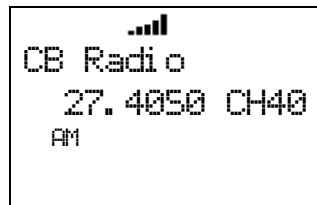

While monitoring the transmission, press [SCAN / srch] in Function Mode or turn [Scroll Control] to resume searching.

Press [L/O] once to temporarily lock out the frequency. The scanner displays "Temporary L/O".

Press [L/O] twice in a second to permanently lock out the frequency. The scanner displays "Locked Out", then resumes searching from the next frequency.

*If you lock out all frequencies in the selected range, the scanner displays "All Locked!" on the second line and searching does not work.

Custom Search

Custom search can start by selecting Custom Search.

When performing a custom search, you can turn on or off custom ranges by pressing the [0 - 9] keys. You cannot turn off the last Custom Range. If you try, the scanner sounds an Error Tone. The scanner only searches turned on custom ranges. The current search range number blinks.

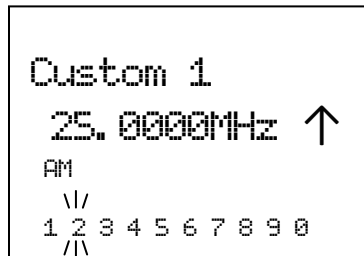

The scanner starts searching from the lowest frequency of the first turned on range and proceeds in ascending order. Or, it starts from the highest frequency of the last turned on range and searches in descending order. While searching, turn [Scroll Control] to change the search direction.

If the scanner finds a transmission, it stops on the frequency and the second line displays the frequency.

While monitoring the transmission, press [SCAN / srch] in Function Mode or turn [Scroll Control] to resume searching.

Press [L/O] once to temporarily lock out the frequency. The scanner displays "Temporary L/O".

Press [L/O] twice in a second to lock out the frequency permanently. The scanner displays "Locked Out", then resumes searching from the next frequency.

If you turn off the current search range number, the scanner searches from the next range.

The scanner stays on a frequency until the delay time expires after a transmission ends.

When you start a Custom Search by selecting "Custom Search" from the Menu, the frequency is initialized and the scanner starts searching. When searching in ascending order, the scanner searches from the lowest frequency of the lowest-numbered turned on Range. When searching in descending order, the scanner searches from highest frequency of the highest-numbered turned on Range.

When the scanner returns to Custom Search by canceling Menu Mode, it resumes searching from the previous frequency in the previous direction. However, if the limit settings of one of Custom Ranges are changed and the previous frequency becomes out of limit, it searches from the lowest frequency of the previous Range for ascending order or from highest frequency of the previous Range for descending order.

Custom Search Temporary Hold :

The scanner searches only the selected range while in Function Mode. When the scanner returns to Normal Mode, it resumes searching all enabled ranges.

Custom Search Range Select :

You can select the range by turning [Scroll Control] in Function Mode. When the scanner returns to Normal Mode, it searches from the selected range.

If you select a range that is turned off, the scanner turns on the range and starts searching from the range.

Custom Search in Control Channel Only Mode

This is valid only for Custom ranges that have the C-CH Only setting turned on at Set C-Ch Only. And this function tracks Motorola and LTR.

The scanner searches only for control channels. If a received transmission is not a control channel, searching resumes immediately.

Receive Motorola Control Channel:

The scanner starts trunking. Acquired TGIDs are displayed. The first line displays the system name and system ID name/ID in turn. The second line displays the TGID. The C-Ch frequency is displayed in the line under the TGID display.

If you have set the correct band plan for the received control channel at Set MOT BandPlan, the scanner will automatically track voice calls on the system.

The scanner toggles the following display while receiving signals.

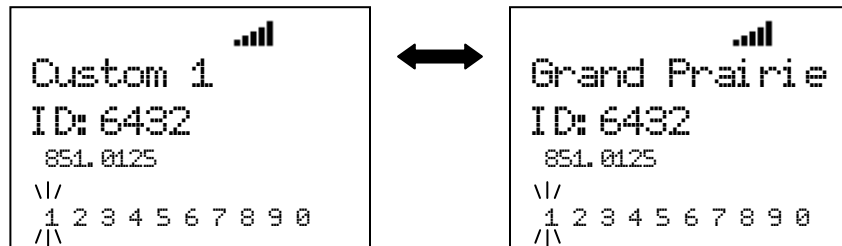

Scanner displays system name.

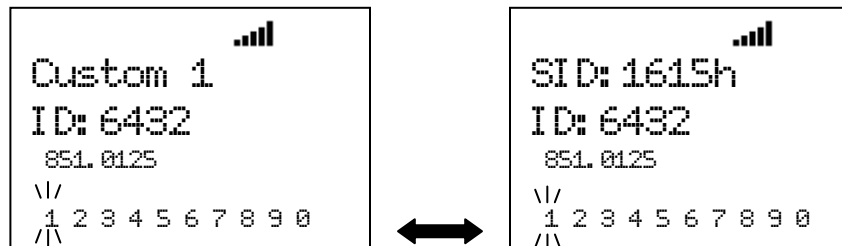

Scanner displays system ID.

If no ID exists, it displays "ID: -----".

Receive LTR Control Channel:

The scanner displays "LT System" and TGID. The scanner toggles the following display while receiving it.

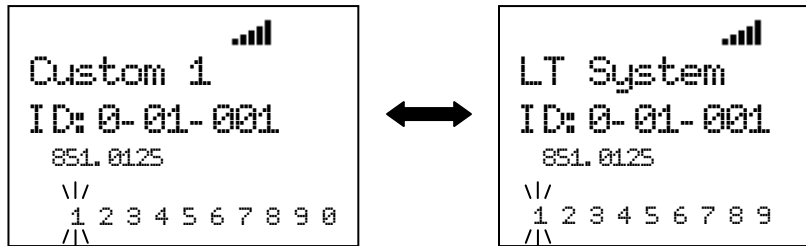

Key Operation :

Turn [Scroll Control] to resume Frequency Search.

When receiving a Motorola control channel, press [6 / RIGHT / disp] key in Function Mode to change the system ID name display (Display Mode 1,3) and system ID display (Display Mode 2). This doesn't work in Scan Mode, because this is used for Group Quick Key operation.

Search and Store

The scanner searches and stores found frequencies or TGIDs automatically. You can make the scanner perform this function by menu selection. See Search and Store for details.

In this operation, the setting of Set C-Ch Only is invalid.

Quick Search

Quick Search searches all bands.

You can start Quick Search by pressing [SCAN / srch] key in Function Mode during Scan Mode, Scan Hold Mode, Close Call Mode, Weather Scan Mode and Tone-Out Mode. The scanner prompts "Quick Search?".

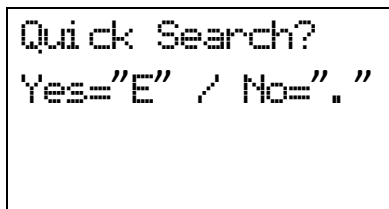

If you press [E / yes / gps], the scanner starts Quick Search.

If you press [./ no / pri], the scanner goes to the Search for... Menu at Search for...

If you press [Hold / , the scanner goes directly to Quick Search Hold Mode.

Pressing [L/O] cancels the prompt and it returns to previous mode.

Quick Search for frequency

The scanner searches from the current channel frequency when the Quick Search starts from monitoring / holding in conventional systems, Close Call Mode, Weather Scan Mode and Tone-Out Mode.

The range of this searching is all ranges of the scanner.

Turn [Scroll Control] to change the searching direction.

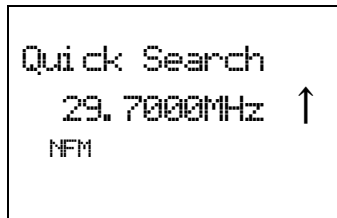

If the scanner finds a transmission, it stops on the frequency and the second line displays the frequency.

While monitoring the frequency, press [SCAN / srch] in Function Mode or turn [Scroll Control] to resume searching.

Press [L/O] once to lock out the frequency temporarily. The scanner displays "Temporary L/O".

Press [L/O] twice in a second to lock out the frequency permanently. The scanner displays "Locked Out", then resumes searching from the next frequency.

Quick Search for TalkGroup ID

When the scanner is on a trunked system in Scan Hold Mode, the scanner performs ID Search operation on the current System. The setting of ID Scan/Search is ID Search. See [Scan for Trunked Systems](#).

Key Operation During Search Mode

Normal Mode

[Scroll Control] knob

Turn this knob to change the searching direction.

While monitoring a frequency, turn this knob to resume searching.

[SCAN / srch] key

Press this key to go to Scan Mode.

[Hold /] key

Press this key to go to Search Hold Mode.

[L/O] key

Press this key to temporarily lock out the current frequency. When the scanner is turned off, the frequency is unlocked.

Press this key twice in a second to permanently lock out the current frequency. When the scanner is turned off, the frequency remains locked.

Long press this key to unlock all frequencies that are locked out in Search Mode and Close Call Mode.

[1 - 9, 0] key

Press this key to turn on or off each custom search range. However, this key operates only in Custom Search and does not operate in other searches.

[E / yes / gps] key

Press this key to quickly store the current frequency.

[MENU] key

Press this key to go to the Menu Mode at Top Menu.

Function Mode

[Scroll Control] knob

Turn this knob to select a custom search range. The scanner restarts searching from the selected search range. This knob operates only in Custom Search and does not operate in other searches.

[SCAN / srch] key

Press this key to resume searching while monitoring a frequency.

[Hold /] key

Press this key to toggle Close Call functions.

Long press this key to start Close Call Only Mode.

[L/O] key

Press this key to go to Rvw Search L/O.

[1 - 3 / sr 1 - 3] key

Press this key to start searching the search range set at Set Search Key.

[4 / LEFT / ifx] Key

While monitoring a frequency, press this key to exchange IF(intermediate frequency).

[6 / RIGHT / disp] Key

Press this key to change the system ID display and system ID name display in custom search if C-Ch Only Mode is on.

[7 / att] key

Press this key to toggle the attenuator state for the search range.

Long press this key to toggle global attenuator.

[8 / rev] key

Long press this key to show the reverse frequency for the current frequency.

And release this key to return to the current frequency.

[9 / mod] Key

Press this key to change the modulation.

[0 / WX] key

Press this key to change WX Alert Priority Mode.

Long press this key to start WX Scan.

[E / yes / gps] key

Press this key to change to the GPS Mode.

[MENU] key

Press this key to go to Search for... in Service Search and Custom Search.

Press this key to go to Srch/CloCall Opt in Quick Search.

SEARCH HOLD MODE

Press [Hold / 

General Operation

The scanner monitors the frequency continuously. The scanner displays the search range name on the first line. In Quick Search, it displays "Quick Search" on the first line. The scanner displays the monitored frequency on the second line.

Turn [Scroll Control] to select the frequency.

Press [L/O] once to temporarily lock out the frequency. The scanner displays "Temporary L/O".

Press [L/O] twice in a second to permanently lock out the frequency. The scanner displays "Locked Out".

Press [L/O] on a locked out frequency to unlock it. The scanner displays "Unlocked".

Long press [L/O] to unlock all frequencies in the current search range. The scanner displays "Srch Lockouts" and "All Unlocked".

Press [SCAN / srch] in Function Mode or [Hold / 

Custom Search Range Select :

Turn [Scroll Control] knob in Function Mode to select the Custom Search Range. Once the Range is changed, the monitoring frequency is set to upper limit frequency or lower limit frequency depends on searching direction. If the direction is ascending order, the frequency is set to lower limit frequency of selected Range. Otherwise, if that is descending order, the frequency is set to upper limit frequency.

Press [Scroll Control] knob again or [SCAN / srch] key to start searching.

Go to Quick Search Hold Directly

When the scanner stops on a received signal or holds on in any Hold Mode, the user can go to Quick Search Hold Mode directly.

Enter a frequency using [0-9] and [. / no / pri] then press [Hold / 

Direct Entry

Enter the frequency or TGID by using the number and decimal keys, then press [E / yes / gps] key to quickly store a channel. (See: Direct Entry for details.)

Quick Save

Press [E / yes / gps] without entering data to quickly store the held frequency.

This Quick Save function is almost the same as Direct Entry.

(See: *Direct Entry* for details.)

The name of the stored frequency is the frequency when the scanner is not receiving location data from a GPS unit.

If you store the detected frequency while receiving location data from a GPS unit, the channel name of the stored frequency becomes the current Latitude/Longitude data.

The channel name format depends on the format set in *Set Pos Format*.

"DMS:DDD°MM'SS.ss" is set

If the latitude data is "32°57'33.60 N" and the longitude data is "97°05'34.18 W", the channel name becomes "3257.33-09705.34".

"DEG:DD.dddddd" is set

If the latitude data is "32.959333 N" and the longitude data is "097.092827 W", the channel name becomes "32.9593-097.0928".

Key Operation During Search Hold Mode

Normal Mode

[Scroll Control] knob

Turn this knob to change the searching direction.

While monitoring a frequency, turn this knob to resume searching.

[SCAN / srch] key

Press this key to go to Scan Mode.

[Hold /] key

Press this key to resume searching.

[L/O] key

Press this key to temporarily lock out the current frequency. When the scanner is turned off, the frequency is unlocked.

Press this key twice in a second to permanently lock out the current frequency. When the scanner is turned off, the frequency stays locked.

Long press this key to unlock all frequencies that are locked out in Search Mode and Close Call Mode.

[1 - 9, 0] key

Press this key to enter numbers and go to Direct Entry.

[. / no / pri] key

Press this key to input decimal point, hyphen or "i" for Direct Entry.

[E / yes / gps] key

Press this key to quickly store the current frequency.

[MENU] key

Press this key to go to the Menu Mode at Top Menu.

Function Mode

[Scroll Control] knob

Turn this knob to select a custom search range. The monitored frequency is set to the upper limit frequency or lower limit frequency, depending on the search direction.

This knob operates only in Custom Search and does not operate in other searches.

[SCAN / srch] key

Press this key to resume searching while monitoring a frequency.

[Hold /] key

Press this key to toggle Close Call functions.

Long press this key to start Close Call Only Mode.

[L/O] key

Press this key to go to Rvw Search L/O.

[1 - 3 / sr 1 - 3] key

Press this key to start searching the search range set at Set Search Key.

[4 / LEFT / ifx] Key

Press this key to exchange IF(intermediate frequency) for the current frequency.

[6 / RIGHT / disp] Key

Press this key to change the system ID display and system ID name display if C-Ch Only Mode is on.

[7 / att] key

Press this key to toggle the attenuator state for the search range.

Long press this key to toggle global attenuator.

[8 / rev] key

Long press this key to show the reverse frequency for the current frequency.

And release this key to return to the current frequency.

[9 / mod] Key

Press this key to change the modulation.

[0 / WX] key

Press this key to change WX Alert Priority Mode.

Long press this key to start WX Scan.

[E / yes / gps] key

Press this key to change to the GPS Mode.

[MENU] key

*Press this key to go to Search for... in Service Search and Custom Search.

Press this key to go to Srch/CloCall Opt in Quick Search.

CLOSE CALL MODE

The basic Close Call feature allows the scanner to immediately lock onto a transmission above a threshold signal strength. The way the scanner treats a Close Call is based on settings of the menu at Srch/CloCall Opt and Close Call.

Display during Close Call Mode

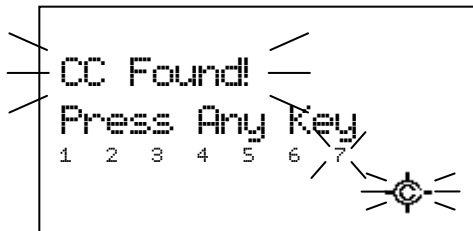

: This icon indicates when the Close Call Mode is "CC Pri".

: This icon indicates when the Close Call Mode is "CC DND".

Close Call Search

*Close Call function does not work in Temporary Hold or System Select of Scan Mode, Weather Scan Mode, Search and Store Mode and Tone-Out Mode.

**While the scanner is staying on a repeater frequency or a reverse frequency, it does not prompt for any new Close Call hits.

The scanner checks Close Call transmissions while scanning or searching every 2 seconds.

If a Close Call hit is found, the scanner alerts the user according to the setting of Set CC Alert, and the Close Call icon blinks.

CC DND is set:

The scanner does not make Close Call checks when it is already receiving a voice transmission.

"DND" means "Do Not Disturb".

CC Pri is set:

The scanner makes Close Call checks even if it is receiving a voice transmission.

You will notice a "gap" every two seconds when receiving a voice transmission.

CC Override is On:

When the scanner gets a Close Call hit, it displays as follows.

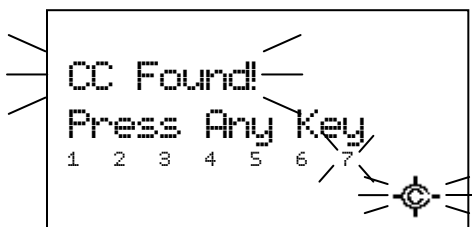

Press any key other than [Hold / ] to listen the detected frequency.

Press [Hold / 

If the scanner gets a Close Call hit in GPS Mode, it displays “Press FUNC Key” on the 4th line.

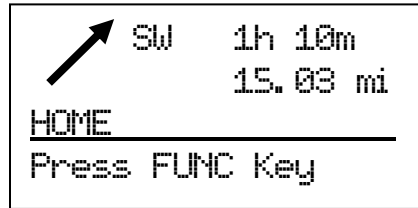

You can listen to the detected frequency by pressing [FUNC] or [Hold / 

CC Override is Off:

When the scanner gets a Close Call hit, it displays as follows.

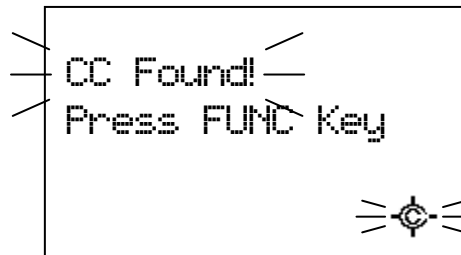

Press [FUNC] or [E / yes / gps] to listen to the detected frequency.

Press [. / no / pri] or don't press any key during the time that is set in Set CC Pause to ignore the Close Call hit and return to the previous state. In this state, pressing [Scroll Control], [L/O] or [Menu] operates the same as pressing [. / no / pri], and other keys are invalid.

If you ignored the hit during the CC Pause time, the scanner will not check for any Close Call transmission for 10 seconds.

Press [Hold / 

When the scanner gets a Close Call hit in GPS Mode, it displays “Press FUNC Key” on the 4th line and you can press [FUNC] or [Hold / 

Monitoring Close Call Transmission:

While monitoring a Close Call transmission, the scanner displays "Close Call" on the first line and the frequency on the second line. The modulation is displayed and the Close Call icon blinks.

If Attenuation, Broadcast Screen or Repeater Find for Srch/CloCall Opt are on, each icon is displayed.

For example, if the scanner finds a transmission on 462.7125 MHz, it displays as follows.



In this condition, the scanner does not check for other Close Call hits.

Press [Hold / 

Turn [Scroll Control] to cancel the monitoring condition. Then the scanner checks the remaining CC Bands. If it gets a Close Call hit, the scanner alerts again. Otherwise, it returns to the previous mode.

Press [L/O] once to temporarily lock out the frequency. The scanner displays "Temporary L/O".

Press [L/O] twice in a second to permanently lock out the frequency. The scanner displays "Locked Out" then resumes searching from the next frequency.

The scanner stays on the frequency until the Delay time expires even if the transmission ends. Then the scanner checks the remaining CC Bands. If it gets a Close Call hit, the scanner alerts again. Otherwise, it returns to the previous mode.

If all the bands are set to Off at Set CC Bands, the scanner does not check for Close Call hits. The scanner displays "Close Call" and "All Band Off!" and sounds an Error Tone when it tries to perform the Close Call check. Then the scanner sets CC Mode to Off of Set CC Mode.

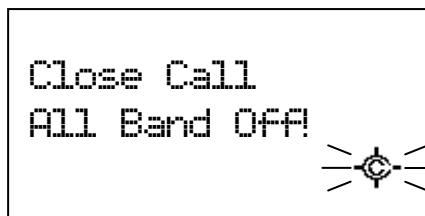

The scanner stays at this state.

In this state, press any key to turn all Close Call bands on.

Close Call Only

The scanner performs this by menu at Close Call Only. Or, long press [Hold / 

The scanner only tries to find a Close Call transmission.

“Close Call” will be displayed on the first line and the Close Call meter is displayed in the second line. This meter indicates the transmission signal level of each band.

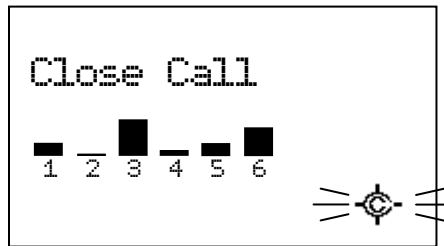

If the scanner has already received a Close Call hit and you press [Hold / 

Press the number keys from [1 / sr1] to [7 / att] to switch each band on or off. You can also use the menu to turn bands on or off. See Set CC Bands.

If the scanner gets a Close Call hit, the scanner displays "CC Found!" and "Press Any Key". And the band number that the found close call belongs to blinks.

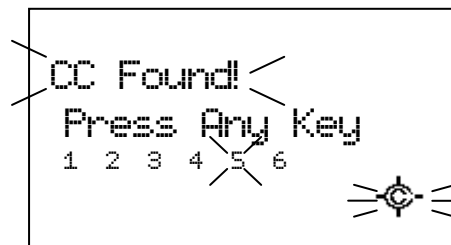

Press any key to see and hear the found frequency.

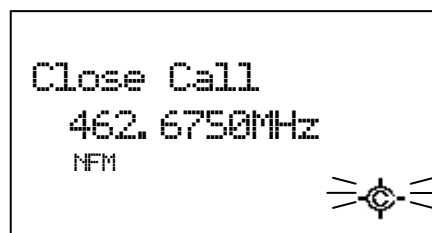

Press [Hold / 

In Close Call Only Mode, press [Menu] in Function Mode to go to Close Call Menu at Close Call.

Monitoring Close Call Transmission:

In this monitoring state, the scanner does not check other Close Call transmissions. Press [Hold / 

While the scanner is monitoring the transmission, turn [Scroll Control] to resume Close Call.

If all the bands are Off at Set CC Bands, the scanner cannot check for Close Call hits. The scanner displays "All Band Off!" and sounds an Error Tone. In this state, press any key to turn all the Close Call bands on.

Close Call Hold

In Close Call Hold, the scanner holds on the current Close Call hit frequency even if the transmission ends. The scanner displays "HOLD" and the held frequency. The Close Call Icon blinks and the modulation type is displayed.

For example, if the scanner finds a transmission on 174.0000 MHz, it displays as follows.

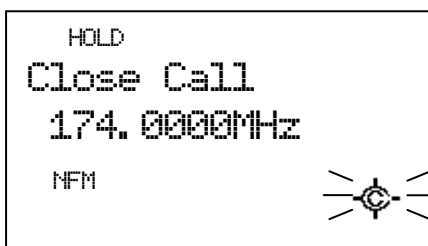

In this condition, the scanner does not check for other Close Call hits.

While holding on a frequency, turning [Scroll Control] goes to Quick Search Hold with the held frequency. And Close Call Mode will be set to off.

Press [Hold / 

*The previous state is one of these modes: Scan Mode, Scan Hold Mode, each Search Mode, each Search Hold Mode, Close Call Only Mode.

Close Call Auto Store

The scanner will automatically store Close Call hits. You can set this function using menu CC Auto Store.

During Close Call Auto Store operation, "SEARCH AND STORE" will scroll on the first Line and the Close Call meter that indicates the transmission signal level of each band will be shown in the second line.



If the scanner finds a Close Call transmission, it displays "CC Found!" on the first line. Then it performs duplication check in the "Close Call" System and displays "Memory Check" on the first line. While storing the frequency to Memory, it displays "Storing" on the first line.

The scanner will stop storing if the number of found frequencies reaches Max Auto Store. Then it displays "Limit Reached" and sounds a Confirmation Tone.

When it exceeds a limit for creating a System/Group/Channel while storing, the scanner stops storing. Then it displays "Over Limit" and sounds an Error Tone.

If the scanner's memory becomes full during the storing operation, it displays "Memory Full" on the first line and sounds an Error Tone.

The scanner does not automatically exit from CC Auto Store Mode.

Pressing [Hold / 

Pressing [Scan / srch] exits this mode and goes to Scan Mode.

Pressing [Menu] exits this mode and goes to Menu Mode. If you exit from Menu Mode, it goes to Close Call Only Mode.

Pressing [Menu] in Function Mode exits this mode and goes to the Close Call Menu.

Pressing [Scan / srch] in Function Mode prompts "Quick Search?" and exits this mode. Then press [E / yes / gps] to go to Quick Search Mode, press [. / no / pri] to go to Search Menu, press [L/O] to cancel the prompt and go to Close Call Only Mode, or press [Hold / 

CC Hit with Scan

The scanner stores the detected frequency in the "Close Call Hits" system. When the scanner is turned off, the stored frequencies are lost.

This system can store up to 10 frequencies. When there are already 10 frequencies in the "Close Call Hits" system, storing a new frequency overwrites the oldest one.

If this system does not have frequencies, the scanner does not scan this system.

The scanner does not store frequencies you skipped by pressing [L/O].

You set the Quick key, lockout state, number tag and hold time for this system at *Hits with Scan*.

Direct Entry / Quick Save / Go to Quick Search Hold Mode

Whenever it is in Close Call Hold Mode, you can enter a frequency or a TGID by pressing [0-9] or [. / no / pri] key, then press [E / yes / gps] to quickly store the entry.

(See *Direct Entry* for details.)

When the scanner monitors or holds on a Close Call transmission, press [E / yes / gps] to quickly store the current frequency.

While monitoring a Close Call frequency, if you turn [Scroll Control], the scanner goes to Quick Search Hold Mode with the frequency.

Key Operation During Close Call Only Mode

Normal Mode

[Scroll Control] knob

While monitoring a frequency, turn this knob to resume close call searching.

[Scan / srch] key

Press this key to go to Scan Mode.

[Hold /] key

If the scanner has already received a Close Call hit, press this key to hold on the frequency.

If not, the scanner will sound an Error Tone.

[L/O] key

While monitoring a frequency, press this key to temporarily lock out the current frequency. When the scanner is turned off, the frequency is unlocked.

Press this key twice in a second to permanently lock out the current frequency. When the scanner is turned off, the frequency stays locked out.

Long press this key to unlock all frequencies that are locked out in Search Mode and Close Call Mode.

[1 - 7] key

Press these keys to turn on/off each Close Call Band. This operation also can be done in menu Set CC Bands.

[E / yes / gps] key

While monitoring a frequency, press this key to quickly store the current frequency.

[Menu] key

Press this key to go to the Menu Mode at Top Menu.

Function Mode

[Scan / srch] key

Press this key to display the prompt for starting Quick Search.

The scanner displays the prompt. Press [E / yes / gps] to start Quick Search, press [./ no / pri] to go to Menu Mode at Search for..., press [L/O] to cancel the prompt or press [Hold / ] to go to Quick Search Hold Mode.

[Hold / ] key

Press this key to set the Close Call Mode to off and go to Scan Mode.

[L/O] key

Press this key to go to Rvw Search L/O.

[1 - 3 / sr 1 - 3] key

Press this key to start searching the search range set at Set Search Key.

[4 / LEFT / ifx] Key

While monitoring a frequency, press this key to exchange IF (intermediate frequency) for the current frequency.

[7 / att] key

Press this key to toggle the attenuator state for Close Call bands.

Long press this key to toggle the global attenuator status.

[8 / rev] key

Long press this key to show the reverse frequency for the current frequency.

And release this key to return to the current frequency.

[9 / mod] Key

Press this key to change the modulation.

[0 / WX] key

Press this key to change WX Alert Priority Mode.

Long press this key to start WX Scan.

[E / yes / gps] key

Press this key to change to the GPS Mode.

[Menu] key

Press this key to go to Close Call

Key Operation During Close Call Hold Mode

Normal Mode

[Scroll Control] knob

Turn this knob to go to the Quick Search Hold Mode.

[Scan / srch] key

Press this key to go to Scan Mode.

[Hold / ] key

Press this key to return to previous mode.

[L/O] key

Press this key to temporarily lock out the current frequency. When the scanner is turned off, the frequency is unlocked.

Press this key twice in a second to permanently lock out the current frequency. When the scanner is turned off, the frequency stays locked.

Long press this key to unlock all frequencies that are locked out in Search Mode and Close Call Mode.

[1 - 9, 0] key

Press this key to input a frequency or a TGID for Direct Entry.

[. / no / pri] key

Press this key to input "i" for Direct Entry.

[E / yes / gps] key

Press this key to quickly store the current frequency.

[Menu] key

Press this key to go to the Menu Mode at Top Menu.

Function Mode**[Scan / srch] key**

Press this key to display the prompt for starting Quick Search.

The scanner displays the prompt. Press [E / yes / gps] to start Quick Search, press [. / no / pri] to go to Menu Mode at Search for..., press [L/O] to cancel the prompt or press [Hold / 

[Hold / 

Press this key to set the Close Call Mode to off and go to Scan Mode.

[L/O] key

Press this key to go to Rvw Search L/O.

[1 - 3 / sr 1 - 3] key

Press this key to start searching the search range set at Set Search Key.

[4 / LEFT / ifx] Key

Press this key to exchange IF (intermediate frequency) for the current frequency.

[7 / att] key

Press this key to toggle the attenuator state for Close Call bands.

Long press this key to toggle the global attenuator status.

[8 / rev] key

Long press this key to show the reverse frequency for the current frequency.

And release this key to return to the current frequency.

[9 / mod] Key

Press this key to change the modulation mode.

[0 / WX] key

Press this key to change WX Alert Priority Mode.

Long press this key to start WX Scan.

[E / yes / gps] key

Press this key to change to the GPS Mode.

[Menu] key

Press this key to go to Close Call

WEATHER SCAN MODE

You can start scanning the 10 Weather Channels either by using the menu or by pressing Function and long pressing [0 / WX].

The scanner scans the 10 Weather Channels normally, or alerts when a 1050 Hz Weather Alert Tone or a SAME Weather Alert is broadcast on a Weather Channel.

You cannot lockout any Weather Channel.

*Close Call function does not work while during Weather Scan Mode even if "Set CC Mode" is "CC DND" or "CC Pri".

Normal Weather Scan

The scanner starts this when you select Weather Scan in Menu Mode at WX Operation.

The scanner scans 10 Weather Channels normally.

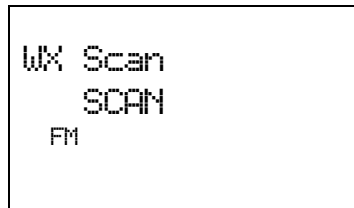

When it finds a broadcast, it stops on the Channel.



If the signal is lost, the scanner resumes scanning for Weather Channels.

Weather Alert Scan

The scanner starts this when you either select the Weather Alert function in Menu Mode at Weather Alert or press Function key and [0 / WX] key in Normal Weather Scan Mode to start this mode.

The scanner scans 10 Weather Channels and alerts when it detects a 1050 Hz Weather Alert Tone or a SAME Weather Alert.

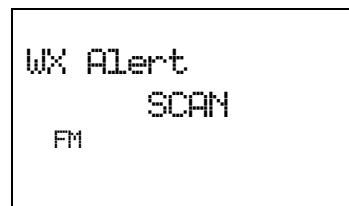

If it is set to Alert Only, the scanner immediately sounds a Weather Alert Siren (for Weather Alert Tone) and displays "Warning WX" and "WX Alert" when it detects the 1050 Hz Weather Alert Tone. This Siren sounds as long as 1050 Hz Weather Alert Tone is broadcasted, or press any key to stop the Siren. Then the scanner opens squelch and remains on the Weather Channel.

If you press any key, the scanner goes to WX Scan Hold Mode and releases the mute.

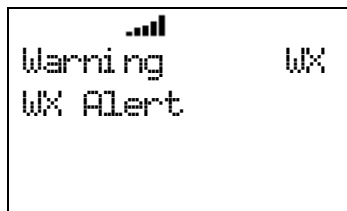

If the scanner is set to one of the SAME Groups, the scanner attempts to decode the SAME data packets that precede the Alert Tone. Then the scanner sounds a Weather Alert Siren (for Warning, Watch or Advisory) when the received County is the same as the programmed data. The scanner displays warning level as "Warning WX", "Watch WX" or "Advisory WX" on the first line and it displays the decoded Event Code on the second line. (See: [CEA2009-SAME EVENT CODE](#) for displayed characters.)

If you press any key, the scanner goes to Weather Scan Hold Mode and releases the mute and remains on the Weather Channel.

If the scanner decodes the EOM (= End of Message) in Weather Alert Scan Mode, it returns to the mute condition. However if the scanner is already in Weather Scan Hold Mode, it will not mute by decoding the EOM.

For example, the scanner displays as follows when it decodes the SAME data that has an Event Code of "EAN".

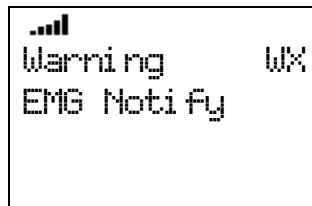

If the scanner is set to All FIPS, the scanner sounds a Weather Alert Siren (for Warning, Watch or Advisory) when it decodes the SAME data packets that precede the Alert Tone. It displays the warning level and Event Code, then opens squelch and remains on the Weather Channel.

*When the scanner detects the SAME data, it sounds each Weather Alert Siren for a maximum of 8 seconds. But you can suspend the siren by pressing any key.

*When the scanner detects the 1050 Hz Weather Alert Tone, it sounds Weather Alert Siren as long as 1050 Hz Weather Alert Tone is broadcasted, or press any key to stop the Siren.

Weather (Alert) Scan Hold

Press [Hold / 

The scanner displays "HOLD" icon and displays "WX Scan" or "WX Alert" on the first line and the Channel Number and frequency on the second line. The scanner checks only the held Channel.



The scanner does not sound until it detects the 1050 Hz Weather Alert Tone or decodes the SAME data in Weather Alert Scan Hold. See: [*Weather Alert Scan*](#) for operation when it detects the 1050 Hz Weather Alert Tone or decodes the SAME data.

Press [Hold / 

Weather Alert Priority (WX Alt Priority)

The scanner interrupts scanning or searching every 5 seconds and checks whether there is a 1050 Hz Weather Alert Tone on Weather Channels.

If the tone is detected, the scanner stays on to the Weather Channel and sounds a Weather Alert Siren (for Weather Alert Tone). Pressing any key stops this Siren.

After the Siren stops, the scanner opens squelch and remains on the Weather Channel.

If you presses any key again, the scanner goes to Weather Scan Hold Mode.

*WX Alt Priority function does not work while the scanner is in Weather Scan Mode, "Search and Store" Mode, Tone-Out Mode or CC Auto Store.

Direct Entry / Quick Save

When the scanner is holding on a Weather Channel, enter a frequency or TGID by pressing the number and decimal keys, then press [E / yes / gps] to quickly store the entered data.

When the scanner is holding or monitoring a Weather Channel, press [E / yes / gps] to quickly store the frequency.

Key Operation During Weather (Alert) Scan Mode

Normal Mode

[Scroll Control] knob

Turn this knob to resume Weather Scan.

[SCAN / srch] key

Press this key to go to Scan Mode.

[Hold /

Press this key to go to Weather Scan Hold Mode.

[E / yes / gps] key

Press this key to quickly store the current frequency.

[MENU] key

Press this key to go to the Menu Mode *at Top Menu*.

Function Mode

[SCAN / srch] key

Press this key to display the prompt for starting Quick Search.

The scanner displays the prompt. Press [E / yes / gps] to start Quick Search, press [./ no / pri] to go to Menu Mode at Search for..., press [L/O] to cancel the prompt or press [Hold / 

[1 - 3 / sr 1 - 3] key

Press this key to start searching the search range set at Set Search Key.

[4 / LEFT / ifx] Key

While monitoring a frequency, press this key to exchange IF(intermediate frequency).

[7 / att] key

Press this key to toggle the attenuator state for the search range.

Long press this key to toggle global attenuator.

[0 / WX] key

Press this key to change to WX Scan or WX Alert Scan.

If you press this key in WX Scan Mode, you can select how the WX Scan works and the scanner starts WX Alert Scan.

Or, the scanner immediately starts WX Scan when this key is pressed in any WX Alert Scan Mode.

[E / yes / gps] key

Press this key to change to the GPS Mode.

[MENU] key

Press this key to go to WX Operation.

Key Operation During Weather (Alert) Scan Hold Mode

Normal Mode

[Scroll Control] knob

Turn this knob to select the Weather Channel.

[SCAN / srch] key

Press this key to go to Scan Mode.

[Hold /

Press this key to resume each Weather Scan.

[1 - 9, 0] key

Press this key to enter numbers and go to Direct Entry.

[./ no / pri] key

Press this key to input decimal point, hyphen or “i” for Direct Entry.

[E / yes / gps] key

Press this key to quickly store the current frequency.

[MENU] key

Press this key to go to the Menu Mode *at* Top Menu.

Function Mode

[SCAN / srch] key

Press to display the Quick Search prompt. Press [E / yes / gps] to start Quick Search, press [. / no / pri] to go to Search for..., press [L/O] to cancel the prompt or press [Hold / 

[1 - 3 / sr 1 - 3] key

Press this key to start searching the search range set at Set Search Key.

[4 / LEFT / ifx] Key

Press this key to exchange IF(intermediate frequency) for the current frequency.

[7 / att] key

Press this key to toggle the attenuator state for the search range.

Long press this key to toggle global attenuator.

[0 / WX] key

Press this key to switch between WX Scan or WX Alert Scan. If you press this key in WX Scan Mode, you can select how the WX Scan works and the scanner starts WX Alert Scan. The scanner immediately starts WX Scan when this key is pressed in any WX Alert Scan Mode.

[E / yes / gps] key

Press this key to change to the GPS Mode.

[MENU] key

Press this key to go to WX Operation.

TONE-OUT MODE

Select "Tone-Out Standby" in *Tone-Out for ...*

Note: In this function, Close Call and WX Priority don't operate.

Display during Tone-Out Mode

Tone-Out Standby

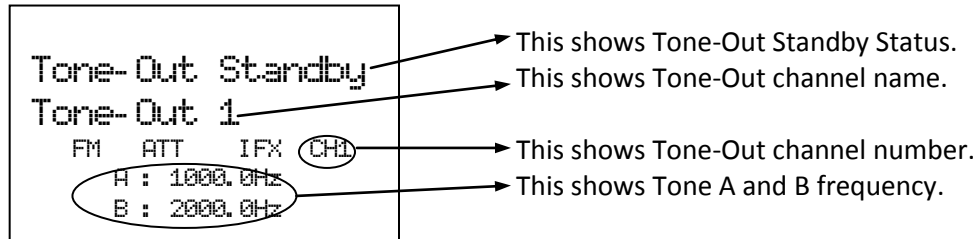

FM : These icons show the modulation type.

ATT : This icon shows the attenuator status of the current channel. When Global attenuator is on, this icon blinks.

IFX : This icon shows when the current channel is an IF exchange frequency.

Tone-Out Search

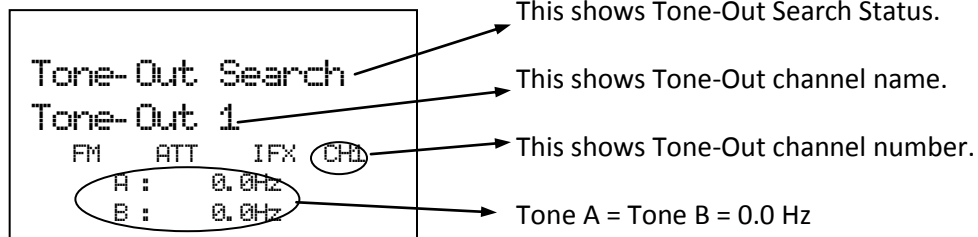

FM : These icons show the modulation type.

ATT : This icon shows the attenuator status of the current channel. When Global attenuator is on, this icon blinks.

IFX : This icon shows when the current channel is an IF exchange frequency.

Tone-Out Standby Mode

If at least one of Tone A and Tone B have a programmed tone, the scanner goes to Tone-Out Standby. While monitoring the Tone-Out frequency, the speaker is muted until matching Tones are detected.

- For two-tone pages, enter a value for Tone A and Tone B.
- For single-tone pages (alert by a single short tone), enter the tone value for Tone A and "0" for Tone B.
- For group tones (alert by a single long tone), enter "0" for Tone A and the tone value for Tone B.

When you set a tone value for Tone A and Tone B, if a transmission is detected, the scanner checks whether the tone is corresponding to Tone A.

If the first tone matches Tone A, the scanner confirms that the tone is present for more than 250ms.

Then the second tone is confirmed whether it detects second tone less than 500ms.

If the second tone matches Tone B and the tone is present for more than 100ms, the scanner opens squelch and activates the alert tone and alert light that you set for this tone set. Then the scanner goes to Tone-Out Hold Mode.

When you set a tone value for Tone A and "0" for Tone B, the scanner confirms that Tone A matches the first tone and is present for the following range.

Tone A: 1.25 – 3.75 sec

Then, the scanner goes to Tone-Out Hold Mode.

Or, when you set "0" for Tone A and a tone value for Tone B, the scanner confirms that Tone B matches the first tone and it is present for more than 3.75 sec.

Then, the scanner goes to Tone-Out Hold Mode.

Multi-Channel Monitoring

The scanner can check multiple tone combination for channels that have the same settings for frequency, Modulation and Attenuator.

For example, the scanner can check tone combination from CH 1 to CH3 at the same time when you program the scanner with the following settings.

	Frequency (MHz)	Modulation	Attenuator	Tone A (Hz)	Tone B (Hz)
CH 1	137.0000	Auto*(NFM)	Off	1000.0	2000.0
CH 2	137.0000	Auto*(NFM)	Off	2200.0	3200.0
CH 3	137.0000	NFM	Off	1500.0	2500.0
CH 4	137.0000	NFM	On	1800.0	2800.0
CH 5	137.0000	FM	Off	2000.0	3000.0
CH 6	138.0000	Auto*(NFM)	Off	1000.0	2000.0

*Modulation setting "Auto" follows the initialization of Band Coverage. However, when modulation of the frequency in Band Coverage is not FM or NFM, it is forced to FM. And "Auto" is compared as NFM or FM with other channel's setting.

*The scanner detects the Tone on the channel that its number is the smallest if you set the same tone in multiple channels.

While Tone-Out Standby Mode for Multi-Channel Monitoring, the scanner switches the channel display every 2 seconds. But the scanner checks all Tones for Multi-Channels simultaneously.

When one of the tone combinations is detected, it goes to Tone-Out Hold Mode.

Tone-Out Search Mode

When both Tone A and Tone B are set to 0.0Hz, this channel will be treated as a Tone-Out Search channel. The scanner starts the Tone-Out Search. During monitoring the Tone-Out frequency, the speaker is muted until Tones are detected.

In Tone-Out Search mode, if a transmission is detected, the scanner starts to check for two-tone pages, single-tone pages and group tones.

For two-tone pages, Tone A must be present for more than 250ms, Tone B must be present for more than 100ms, and the time gap between Tone A and Tone B must less than 500ms.

For single-tone pages, the Tone must be present between 1.25-3.75 seconds.

For group tones, Tone must be present for more than 3.75 seconds.

If one kind of these tones is detected, the scanner begins to check whether it has been registered in another tone-out channel with the same setting for frequency, Modulation and Attenuator. If it has been registered, the scanner goes to Tone-Out Hold Mode with the registered channel number. If not, the scanner goes to Tone-Out Hold Mode with the current Tone-Out search channel number.

Note: A Tone-Out Search channel is not treated as Multi-Channel even it has the same setting of frequency, Modulation and Attenuator with other channels.

When in Tone-Out Search Mode, scanner will not switch the channel display each 2 seconds for the Multi-Channel.

Tone-Out Hold Mode

You can hear the transmission in Hold Mode. When the transmission ends and the delay time expires, the scanner returns to standby condition or search condition. Or pressing [Hold / ] also returns to standby condition or search condition.

You can change to Hold Mode from Standby Mode of Search Mode by pressing [Hold / ]. Tone-out Hold Mode has no timeout.

If the scanner detects a new tone-out sequence that has not been register yet. The found tone-out sequence will flash.

You can return to the Tone-Out Search Mode by pressing [Hold / ].

If you press [E / yes / gps], you will be prompted to save the new detected tone-out sequence.

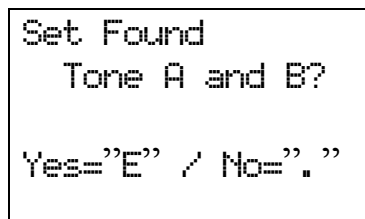

```
Set Found  
Tone A and B?  
Yes="E" / No="."
```

Press [E / yes / gps] to save the new tone-out sequence and move to the tone-out setting menu Tone-Out Settings. Press [./ no / pri] to cancel the new tone-out sequence and move to the tone-out setting menu Tone-Out Settings.

Note: If you change the Channel by turning the scroll control when in Hold Mode, the Hold condition is canceled and it moves to next channel.

Key Operation During Tone-Out Mode

Normal Mode

[Scroll Control] Knob

Turn this knob to change the channel. Then the scanner is muted if it releases the mute.

[Scan / srch] key

Press this key to go to Scan Mode.

[Hold /] Key

In Tone-Out Standby Mode or Tone-Out Search Mode, press this key to go to Tone-Out Hold Mode and release the mute.

In Tone-Out Hold Mode, press this key to go to Tone-Out Standby Mode or Tone-Out Search Mode, and the scanner is muted.

[1 - 9, 0] key

Press this key to enter a frequency or a TGID for Direct Entry.

[. / no / pri] key

Press this key to input "i" for Direct Entry.

[E / yes / gps] key

Press this key to go to the channel menu at *Tone-Out Settings*.

[Menu] Key

Press this key to go to the Menu Mode *at* Top Menu.

[L/O] Key

This key will be ignored.

Function Mode

[Scan / srch] key

Press this key to display the prompt for starting Quick Search.

The scanner displays the prompt. Press [E / yes / gps] to start Quick Search, press [. / no / pri] to go to Menu Mode at Search for..., press [L/O] to cancel the prompt or press [Hold / 

[Hold /

Press this key to go to Close Call Mode.

Long press this key to go to Close Call Only Mode

[1 - 3 / sr 1 - 3] key

Press this key to start searching the search range set at Set Search Key.

[4 / LEFT / ifx] key

Press this key to exchange IF (intermediate frequency) for the current frequency.

[7 / att] key

Press this key to toggle the attenuator setting.

Long press this key to toggle the global attenuator setting.

[9 / mod] key

Press this key to change the modulation.

[0 / WX] key

Press this key to change WX Alert Priority Mode.

Long press this key to start WX Scan.

[E / yes / gps] key

Press this key to change to the GPS Mode.

[Menu] key

Press this key to go to Tone-Out for

GPS MODE

By connecting a GPS Unit, the scanner can operate the following functions.

- Automatic lockout control for Scan Systems, Sites, and Channel Groups
- Navigation to POI (Point Of Interest)
- Location Alerts

This mode guides to the destination by connecting a GPS Unit to the serial port of the scanner and receiving location data through it.

You must set the scanner's baud rate to the same as the GPS unit. This is normally 4800 bps

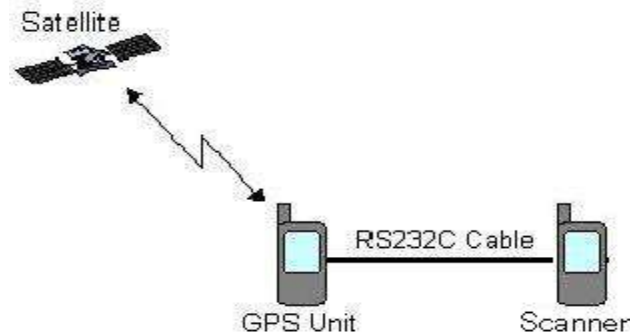

The formats of the GPS data that the scanner can receive are only GGA (Global Positioning System Fix Data) and RMC (Recommended Minimum Specific GNSS Data) based on "NMEA-0183 ver.3.01".

Display Mode in GPS Mode

There are 6 kinds of Display Mode in GPS Mode; GPS DATA, ETA, Clock, Elevation, Speed and Location. And there are two displays for a GPS Data receipt error.

If you do not select any POI, the Display Mode can be selected from GPS DATA and Location. Press [6 / RIGHT / disp] in Function Mode to change the Display Mode to the opposite side.

Or, if a POI is selected, the Display Mode can be selected from ETA, Clock, Elevation, Speed and Location. Press [6 / RIGHT / disp] in Function Mode to toggle the Display Modes in order.

*In GPS Mode, the 4th line displays the background operation of Scanner Mode. However, nothing is displayed on this area when the scanner goes to GPS Mode from Band Scope Mode.

Examples of each Display Mode are as follows.

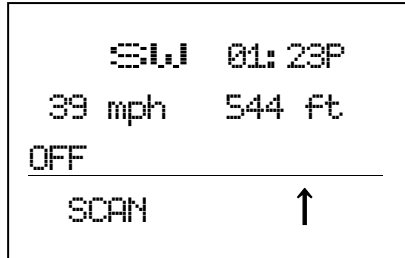

GPS DATA Display

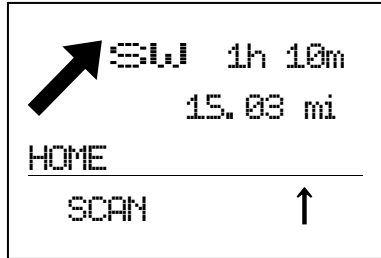

ETA Display

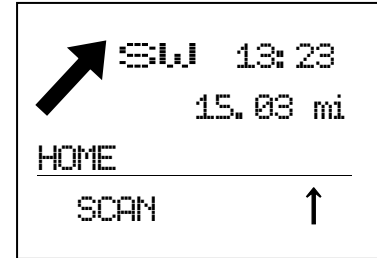

Clock Display

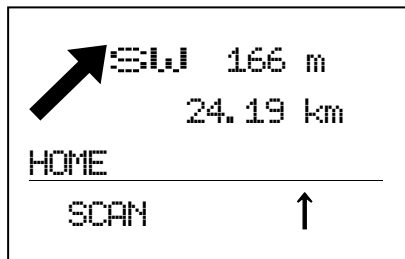

Elevation Display

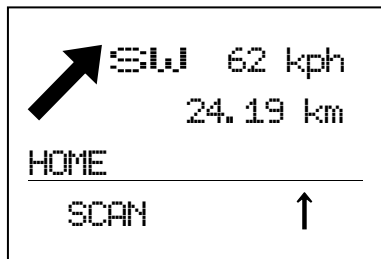

Speed Display

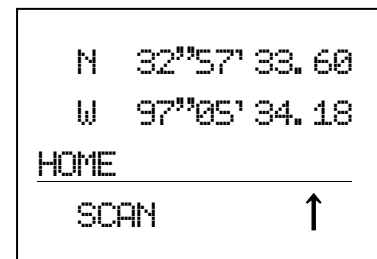

Location Display

GPS DATA Display

This Display Mode displays the direction of travel, the time, the speed and the elevation.

- The left side of the 1st line displays the current direction of travel.
- The right side of the 1st line displays the present time.
- The left side of the 2nd line displays the current speed.
- The right side of the 2nd line displays the elevation of the current location.
- The 3rd line always displays "OFF" because a POI is not selected.

ETA / Clock / Elevation / Speed Display

These Display Modes display the direction and the distance for the selected POI, the direction of travel and individual information.

- The large arrow shows the direction to the selected POI.
- The left side of the 1st line displays the current direction of travel.
- The 2nd line displays the distance to the selected POI.
- The right side of the 1st line displays individual information.
 - ETA Display Mode shows the ETA (Estimated Time for Arrival) to the selected POI.
 - Clock Display Mode shows the present time.
 - Elevation Display Mode shows the elevation of the current location.
 - Speed Display Mode shows the current speed.

The name of the selected POI is displayed on 3rd line.

Location Display

This Display Mode displays the latitude and longitude of the current location.

- The 1st line displays the latitude of the current location.
- The 2nd line displays the longitude of the current location.
- The 3rd line displays "OFF" (when a POI is not selected) or the name of the selected POI.

Display Formats of Each Information:

- The advance direction: This is one of N, NE, E, SE, S, SW, W and NW.
- The time: The time is displayed as "*hh:mm*" (*hh*: hour, *mm*: minute). If "12H" is selected at Set Time Format, "A" or "P" is displayed at a right end.
- The speed: This is a triple digits. According to the setting of Set Unit, "mph" (mile/hour) or "kph" (km/hour) is displayed for a unit.
- The elevation: This is displayed as "*EEEE* ft" (*EEEE*: elevation of a positive number) or "*-EEE* ft" (*EEE*: elevation of a negative number) using four digits. According to the setting of Set Unit, "ft" (feet) or "km" is displayed for a unit.
- The direction for the POI: One of eight directions is shown. There are "↑", "↗", "→", "↘", "↓", "↙", "←" and "↖". In Function Mode, this arrow changes to small one.
- The distance for the POI: This is displayed as "*DDDD.dd* mi" (*DDDD.dd*: distance). According to the setting of Set Unit, "mi" (mile) or "km" is displayed for a unit.
- The ETA to the POI: This is displayed as "*hhh mmm*" (*hh*: hour, *mm*: minute).
- The latitude: This is displayed as "N" or "S" and "*DD°MM'SS.ss*" (for DMS format) or "*DD.ddddd*" (for DEG format).
- The longitude: This is displayed as "W" or "E" and "*DDD°MM'SS.ss*" (for DMS format) or "*DDD.ddddd*" (for DEG format).

Error Display

When the scanner does not receive GPS data, the scanner displays “No GPS Input”.

When the scanner is searching for the satellite, the scanner displays “Searching for Satellite”.

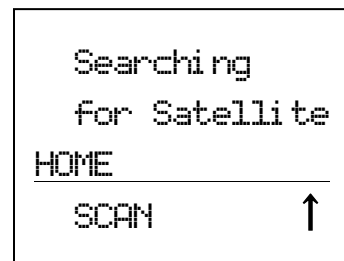
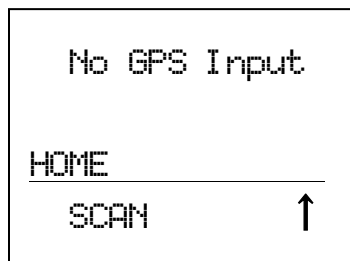

You can select a POI by turning [Scroll Control] knob even if the scanner displays an error message.

Location Alert Operation

This alerts you when you approach a destination, a Dangerous Xing or a Dangerous Road by ringing an alert.

Location Alert System Types have “POI (Point Of Interest)”, “Xing (Dangerous Xing)” and “Road (Dangerous Road) “.

Display with Location Alert

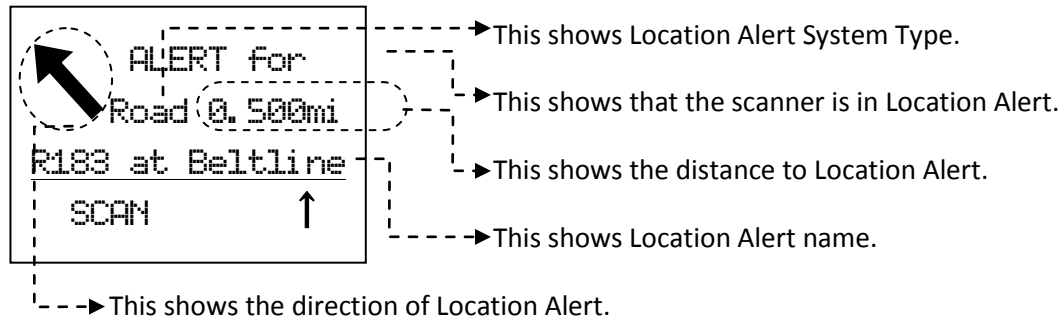

While displaying the **F** icon, Location Alert arrow changes to a small font.

Point Of Interest

The alerts you by ringing an alert if you approach the selected destination. The timing to which the alert rings is set up in Set LocationInfo. Or, the alert is set up in Set Alert.

The screen displays "ALERT for" on the first line. And the second line displays "POI" as Location Alert System Type and the distance to the destination.

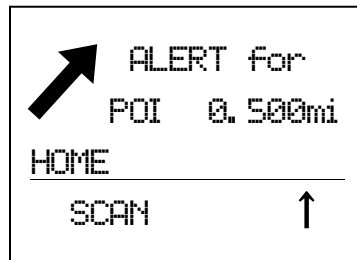

Dangerous Xing / Road

The scanner may ring an Alert three times at different timings.

The screen displays "ALERT for" on the first line. And the second line displays the Location Alert System Type and the distance to the Alert Location. An arrow which shows the direction of Alert Location is displayed too. Alert Light is turned on. (See: Set Alert Light.)

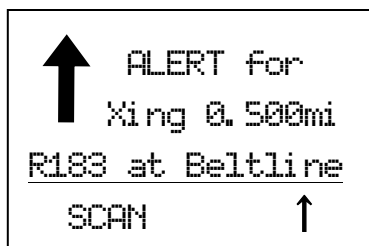

Dangerous Xing

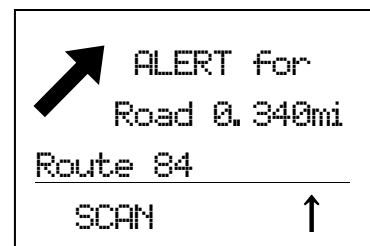

Dangerous Road

There are three ranges for Alert, 1.0mile, 0.50 mile and 0.10 mile if you select "mile" as the unit. If you select "km" as the unit, the alert distances are 1.0km, 0.50 km and 0.10 km. (See: Set Unit)

The scanner alerts only once for each range when it meets both of the following two conditions.

- First condition is heading for Alert Point. This is cleared when you heading is within $\pm 45^\circ$ of the value that is set in *Set Heading*.
- The second condition is speed. It meets this condition when the current speed exceeds the speed that is set in *Set Speed Limit*.

For example, see the following illustration. Car 1 is traveling within the range of the alert location point and its heading is within the point's set direction.

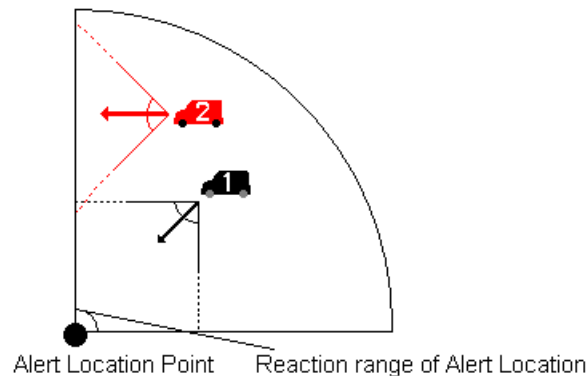

Car 2 is traveling within the range of the alert location, but its direction is outside the point's set direction.

If Car 1 is running at a speed higher than the limit set for the point, the scanner rings an Alert, the display changes to Location Alert Mode and the Alert Light is turned on.

If Car 1 is running at speed lower than the limit set for the point, the scanner does not ring an alert, the display changes to Location Alert Mode.

If Car 1 accelerates to a speed higher than the limit set for the point after it enters range, the scanner will ring an Alert and the Alert Light is turned on.

On the other hand, no Alert (Alert display, Alert Light, and Alert Beep) will sound for Car 2 regardless of its speed.

Lockout Operation

The scanner temporarily locks out the current Location Alert if you press [L/O] once while an alert for the location is active. The scanner automatically unlocks the locked out location when it moves 4 miles or more from the Alert Point.

The scanner permanently locks out the current Location Alert if you press [L/O] twice in a second. As long as you do not unlock the locked out location at menu (See: *Set Lockout*), Location Alert Operation and Alert Light for the locked out location does not work.

Turn [Scroll Control] during a location alert to temporarily lockout the displayed Location Alert.

Priority for Location Alert

When a Location Alert with a higher priority occurs during a Location Alert, the current Location Alert is canceled and the scanner alerts for the Location with the high priority.

The priority order is as follows:

- 1) Dangerous Road
- 2) Dangerous Xing
- 3) Point of Interest

GPS Operation during Scanner Display

If a Location Alert occurs when the scanner is displaying the scanner screen, the scanner displays the Location Alert data in reverse type on the bottom line and the Alert Light turns on. The scanner displays the direction of the Location Alert, Location Alert system type and the distance to the Location Alert.

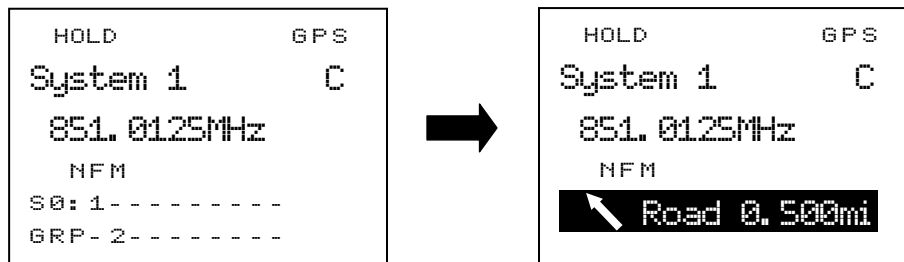

During the Location Alert, the scanner carries out the Location Alert operation with the scanner operation display. When the Location Alert operation finishes, the scanner returns to the usual scanner display.

Registration of Location Information

You can store current location data and the heading value by long pressing [E / yes / gps] key in Function Mode.

The moment you press [E / yes / gps] key in Function Mode, the scanner holds the current location data.

Then the scanner displays the dialog for selecting a location type. By pressing [E / yes / gps] for type selection, registration is completed and the name and location of stored location are displayed.

The stored data is named as "T YYMMDD hhmmss" that shows a type, date and the time.

Note: "T" means location system type. (P : POI / R : DRD / X : DXG) "YY" means year. "MM" means month. "DD" means day. "hh" means hour. "mm" means minute. "ss" means second.

For example, when a default name is "X 091020 102554", the system type is Dangerous Xing and was stored in 2009/10/20 10:25:54.

However, if the connection of GPS Unit is invalid, the scanner beeps an error tone when [E / yes / gps] is pressed.

*You can register current Location Information to a previously stored Location, too. For this operation, long press [FUNC] + [E / yes / gps] key in Review Location Mode. (See [Review Location Mode](#) for details.)

Review Location Mode

*In this mode, scanning/searching operation, navigation and Location Alert operation are invalid.

You can review all created Locations.

In GPS Mode, press [E / yes / gps] to go to Review Location Mode.

At first, the last displayed Location is selected.

The first line displays "Review Location" and the second line displays the Name of the Location. Location Type, Lockout status and GPS icon are displayed above the first line. Other parameters are displayed under the second line.

For POI, Range is displayed as "RANGE:0.10 MILE" or "RANGE:0.10 KM". For Dangerous Xing or Dangerous Road, Heading and Limit Speed are displayed as "HEAD:xxx" and "LS: 75M" (or "LS:75K"). The xxx is one of ALL, N, NE, E, SE, S, SW, W and NW.

Latitude and Longitude are displayed at the bottom of the screen.

Displays of each Type are as follows.

```
POI  L/O  GPS
Review Location
Hollywood
RANGE: 0.10 MILE
N  00° 00' 00.00
W 000° 00' 00.00
```

POI

```
DXG  L/O  GPS
Review Location
Crossroad
HEAD: ALL LS: 75M
N  00° 00' 00.00
W 000° 00' 00.00
```

Dangerous Xing

```
DRD  L/O  GPS
Review Location
Crossroad
HEAD: NW  LS: 75K
N  00.000000
W 000.000000
```

Dangerous Road

Key Operation

Key Operation of Review Location Mode is different from normal GPS Mode.

Turn [Scroll Control]: Select a Location from all stored Locations. In this mode, Locations are sorted by Location Type. The order of Type is POI, Dangerous Xing and Dangerous Road. Locations are sorted by Name in each Type.

Turn [Scroll Control] in Function Mode: This skips to the location that starts with the next letter of the alphabet.

Press [SCAN / srch]: Go to Scan Mode.

Press [Hold / 

Press [L/O] key: Change the lockout status of the displayed Location.

Long press [L/O]: Unlock all Locations of the current Type. "Unlocked All TTTs?" and "Yes="E" / No="." are displayed. The "TTT" shows Location Type as POI, DXG or DRD.

If you press [E / yes / gps], the scanner unlocks all locations of the current Type.

If you press [. / no / pri], the scanner returns to the previous mode without unlocking.

Long press [L/O] in Function Mode:

Display the prompt "Unlock All Locations?" to unlock all Locations of all Types.

If you press [E / yes / gps], the scanner unlocks all locations.

If you press [. / no / pri], the scanner returns to the previous mode without unlocking.

Press [. / no / pri]:

Return to GPS Mode.

[E / yes / gps]:

Go to the location edit menu for the selected Location.

- The construction of this edit menu is the same as the Menu of *POI Settings* or *Dangerous Xing / Road Settings*. However, pressing [MENU] in this edit menu returns to Review Location Mode, and pressing [L/O] in this menu goes to GPS Mode.
- If you select "New Location" in the editing menu, the scanner returns to Review Location Mode with new Location activation.
- If you select "Delete Location" in the editing menu, the scanner returns to Review Location Mode and the next Location is selected. If you've deleted all locations, the scanner returns to the GPS Mode immediately.

Long press [E / yes / gps] in Function Mode:

Overwrite the Latitude/Longitude of selected Location using the current Location Data from the GPS Unit. "Storing Location" is displayed and the scanner sounds an Exec Tone.

- If the GPS connection is invalid, it can not overwrite and the scanner beeps an error tone when [FUNC] + [E / yes / gps] is pressed.

Press [MENU]:

Return to GPS Mode.

Key Operation During GPS Mode

*Refer to Review Location Mode for Key Operation of Review Location Mode.

Normal Mode

[Scroll Control] knob

Turn this knob to select a POI.

While displaying the **F** icon, the location alert arrow changes to a small font.

Turn this knob during a location alert to temporarily lockout the displayed Location Alert.

[SCAN / srch] key

Press this key to return to the previous mode in scanner screen.

[Hold /] key

This key works on scanner operation which is running in the background.

If scanner operation is Scan Mode or Search Mode, the scanner goes to Hold Mode by pressing this key. Or it is Scan Hold or Search Hold, the scanner resumes scanning or searching.

[L/O] key

Press this key once to temporarily lockout the current Location Alert during a Location Alert.

When the scanner is turned off, the frequency is unlocked. Or, the scanner automatically unlocks the locked out location when it moves 4 miles or more from the Alert Point.

Press this key twice in a second to permanently lockout the current Location Alert during a Location Alert.

When the scanner is turned off, these locations remain locked out.

[E / yes / gps] key

Press this key to go to Review Location Mode.

[MENU] key

Press this key to go to the Menu Mode at Top Menu.

Function Mode

[Scroll Control] knob

Turn this knob to skip to the location that starts with the next alphabetic character.

Press this knob to go to Normal Mode.

[L/O] key

Press this key once to temporarily lockout the current Location Alert during a Location Alert.

When the scanner is turned off, the frequency is unlocked. Or, the scanner automatically unlocks the locked out location when it moves 4 miles or more from the Alert Point.

Press this key twice in a second to permanently lockout the current Location Alert during a Location Alert.

When the scanner is turned off, these locations remain locked out.

[6 / RIGHT / disp] key

Press this key to change the GPS Display.

[E / yes / gps] key

Long press this key to store the current location.

[MENU] key

Press this key to go to the editing menu for the current location system.

OBAND SCOPE MODE

Band Scope Mode searches a frequency range and displays the signal level in real time.

You can set the center frequency and span of the frequency range.

In Hold Mode, you can monitor the displayed frequency.

*Close Call, Priority Scan, Weather Scan and GPS functions do not work in Band Scope Mode.

Scope Mode

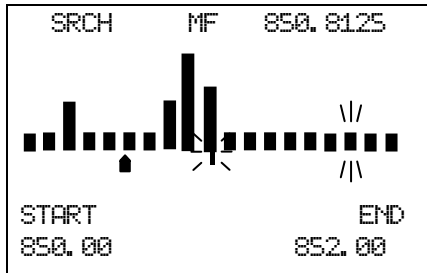

Search Mode with Normal Screen

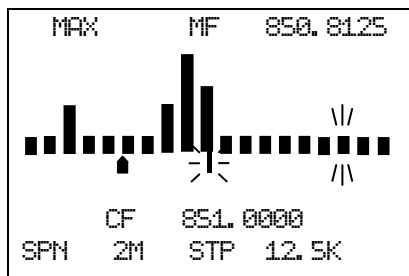

Search Mode with Setting Screen

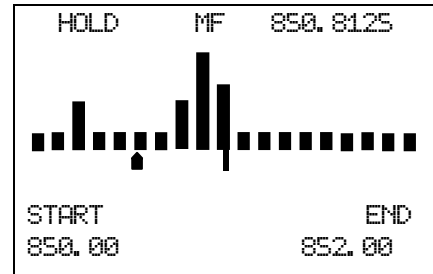

Hold Mode with Normal Screen

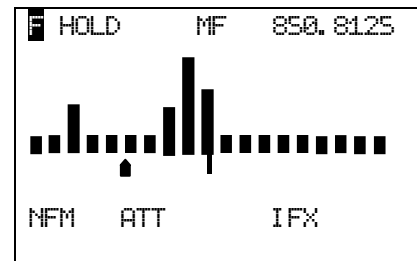

Hold Mode in Function Mode

SRCH	:	This icon appears while in Search Mode.
MAX	:	This icon appears while in MAX Hold Search Mode. This shows in the same place as " SRCH ".
HOLD	:	This icon appears while in Hold Mode. This shows in the same place as " SRCH ".
MF 850.8125:		This icon and number show the marker frequency.
■	:	This icon shows the signal level.
▲	:	This icon shows the marker point.
┆	:	This icon shows the center frequency point.
START 850.00 :		This icon and number shows the start frequency of the search range.
END 852.00 :		This icon and number shows the end frequency of the search range.
CF 851.0000 :		This icon and number shows the center frequency.
SPN 2M :		This icon and parameter shows the frequency span.
STP 12.5K:		This icon and parameter shows the search step.
NFM	:	This icon shows the modulation type.
ATT	:	This icon appears when the attenuator state for a range is On.
IFX	:	This icon appears on the frequency has IF exchange On.

Search Mode

The scanner searches and displays the signals of the frequency range in real time.

The scanner displays "SRCH".

The frequency range expressed in 32 bars is determined by the center frequency and span.

If the frequency range includes outside of the range from 25.0000 to 1300.0000 MHz, the scanner does not search that range.

While searching, the center frequency icon and the bar which shows the current frequency blink.

The scanner starts from the lowest frequency of the frequency range and searches in ascending order.

If the scanner finds a transmission, the scanner displays a signal level (0-7) in the bar including the frequency.

If the scanner finds some signals in the bar, the strongest and the latest signal are displayed.

Note: If a signal is outside of band coverage, the scanner doesn't search it.

Press [FUNC] + [Scan / srch] in Max Hold Search Mode to go to this mode.

Max Hold Search Mode

The scanner searches the signals of the frequency range.

The scanner displays the frequency for the strongest signal.

The scanner displays "MAX".

The other functions are the same as Search Mode.

Press [FUNC] + [Scan / srch] in Search Mode to go to this mode.

Hold Mode

You can monitor frequency displayed in this mode.

The scanner displays "HOLD".

Center frequency icon and bars do not blink different from Search or Max Hold Search Mode.

You can select the frequency to monitor by moving the marker pointer.

Turn Scroll Control, the marker changes the frequency every step.

Turn Scroll Control in Function Mode, the marker changes the frequency every bar.

Press [Hold / 

General Operation

Normal Screen

This screen is usually displayed in Band Scope Mode.

This screen displays the start and end frequency of the range on the bottom line.

You can control the marker to monitor a frequency in Hold Mode and register the marker frequency as the center frequency.

Setting Screen

This screen is displayed to operate the band scope settings.

This screen displays center frequency of the range, search step and span of the range on the bottom line.

You can change these parameters.

Press [./no/pri] while on the normal screen to display this screen.

In this screen, press [./no/pri] to select the next setting item.

The icon of the selected item blinks.

You can change the selected item's parameter (except "CF") by turning the Scroll Control.

When the "CF" is selected, go to the edit frequency menu to change the center frequency by pressing [E / yes / gps]. (See [Edit Frequency.](#))

If you change a parameter, the scanner clears the search result and searches again.

The scanner returns to a normal screen 10 seconds after the last operation or by pressing [L/O].

Function Mode

Press [FUNC] to go to Function Mode and display the modulation, the attenuator and IF Exchange.

Restart Searching

This function is used to clear the search result and search again.

You can restart searching by pressing [FUNC] + [L/O].

The scanner also restarts searching if you change any parameter or search mode.

In Hold Mode, the scanner searches a search range only once.

Search Setting Parameters

Center Frequency

This parameter is the center frequency of the search range.

*Please see: [Band Coverage](#) for acceptable frequencies.

When you go to Band Scope Mode from another mode with a frequency, the scanner sets that frequency as the center frequency.

Span

This parameter is the span of the search range.

You can select from 0.2 / 0.4 / 0.6 / 0.8 / 1 / 2 / 4 / 6 / 8 / 10 / 20 / 40 / 60 / 80 / 100 / 120 / 140 / 160 / 180 / 200 / 250 / 300 / 350 / 400 / 450 / 500 (MHz).

Search Step

You can change the search step to find a transmission.

The search time changes depending on the search step size.

You can select from 5 / 6.25 / 7.5 / 8.33 / 10 / 12.5 / 15 / 20 / 25 / 50 / 100 (kHz).

Modulation

Modulation can be selected from AUTO / AM / NFM / FM / WFM / FMB.

This parameter is used in HOLD Mode.

When you go to Band Scope Mode from another mode with a frequency, the scanner sets the other mode's modulation as Band Scope Mode's modulation.

Key Operation during Band Scope Mode

Normal Mode during Normal Screen

[Scroll Control] Knob

Sets the level in Volume / Squelch Level Control mode.

Turn this knob, the marker changes the frequency every step.

[Scan / srch] Key

Press this key to go to Scan Mode.

[Hold /] Key

In Search or Max Hold Search Mode, press this key to go to Hold Mode.

In Hold Mode, press this key to return to the previous search mode.

[./ no / pri] Key

Press this key to display a setting screen.

[E / yes / gps] Key

Press this key to register the marker frequency as the center frequency.

[Menu] Key

Press this key to enter the Menu Mode.

Normal Mode during Setting Screen

[Scroll Control] Knob

Sets the level in Volume / Squelch Level Control mode.

Turn this knob to change the selected item parameter except "CF" item.

[Scan / srch] Key

Press this key to go to Scan Mode.

[Hold /] Key

In Search or Max Hold Search Mode, press this key to go to Hold Mode.

In Hold Mode, press this key to return to the previous search mode.

[./ no / pri] Key

Press this key to select the next setting item.

[E / yes / gps] Key

When the "CF" item is selected, press this key to go to the edit menu for the center frequency.

[Menu] Key

Press this key to enter the Menu Mode.

Function Mode

[Scroll Control] Knob

Sets the level in Volume / Squelch Level Control mode.

Turn this knob, the marker changes the frequency every bar.

[Scan / srch] Key

Press this key in Search Mode to go to Max Hold Search Mode.

Press this key in Max Hold Search Mode to go to Search Mode.

In Hold Mode, press this key to restart searching.

[Hold /] Key

Press this key to toggle Close Call functions.

Long press this key to start Close Call Only Mode.

[L/O] Key

Press this key to restart searching.

[1 - 3 / sr1 - 3] Key

Press this key to start Service Search, Custom Search, Tone-Out Mode or Band Scope Mode in Set Search Key.

[4 / LEFT / ifx] Key

In Hold Mode, press this key to exchange IF(intermediate frequency).

[7 / att] key

Press this key to toggle the attenuator state for the search range.

Long press this key to toggle global attenuator.

[9 / mod] Key

Press this key to change the modulation.

[0 / wx] Key

Press this key to change WX Alert Priority Mode.

Long press this key to start WX Scan.

[E / yes / gps] Key

Press this key to change to the GPS Mode.

[Menu] Key

Press this key to enter the Menu Mode.

WIRED CLONE MODE

You can clone almost all the data of one scanner to another.

After connecting the two scanners, turn on the two scanners. Then select "Master" or "Slave" Wired Clone.

Confirm State

First, you select Master or Slave.



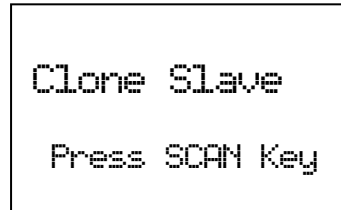

Master Unit



Slave Unit

Press [Scan / srch] on the Slave Unit, then on the Master Unit. The Master Unit checks whether the Slave Unit is connected correctly. When the Master Unit receives an acceptable response from the Slave Unit, the data transfer is started from the Master Unit to the Slave Unit. If the Master Unit doesn't receive an acceptable response in 10 second, it fails with an error.

Press [L/O] to return to Menu Mode at Wired Clone.

In the Slave Unit, when [Scan / srch] key is pressed and the display is "Clone Slave Waiting Data", the only control that will work is [ /  / ] for turning off the scanner and turning on the backlight.

Transferring State

During the data transfer, the scanners display a progress message. ("=" shows progressing transfer.)

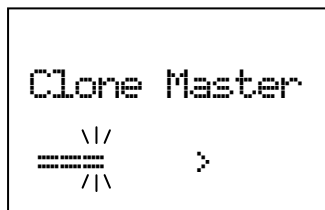

Master Unit

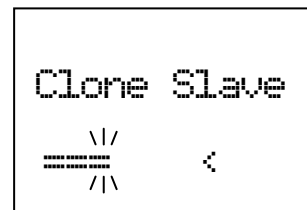

Slave Unit

Complete State

When the data transfer is completed, the scanners display "Complete".

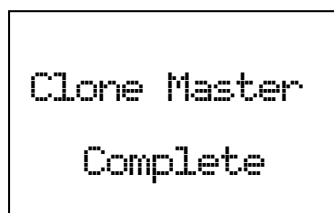

Master Unit

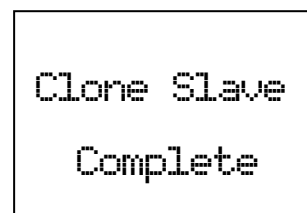

Slave Unit

Press [L/O] on the Master Unit to return to Confirm State.

When you reboot the Slave Unit, it has the new cloned data.

Note: When you reboot the Slave Unit, the Unit will check and erase the protected systems first, this process may take a few minutes which depend on the how many protected systems there are.

Error State

If the data transfer is not successful, the "Error" message appears.

Press [L/O] to return to Confirm State. Or power off the scanner.

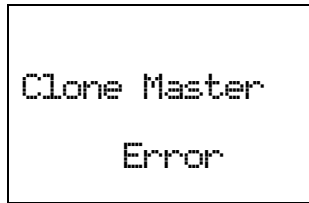

Master Unit

Note: The Slave Unit does not have an Error State. Even if the Slave Unit receives invalid data, it continues waiting for valid data.

Key Operation During Clone Mode



Confirm State

[Scan / srch] key : The scanner start data transfer.

[Menu] key : The scanner goes to Menu at Wired Clone



[FUNC] + [Menu] key : The scanner goes to Menu at Wired Clone

[L/O] key : The scanner goes to Menu at Wired Clone

[ /  / 



Another State

[L/O] key : The scanner goes back Confirm state. (Master Unit)





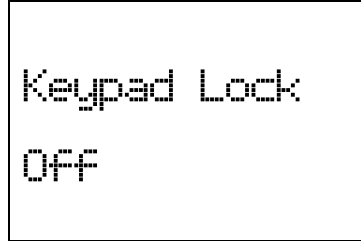

[ /  / 

Note: If you turn off the Slave scanner before cloning completes, memory is cleared when you turn the scanner back on.

KEYLOCK

Press [Func] + [ /  / 



While the keypad is locked, any key operation other than [Hold / ], [ /  / , [Func] and turning [Scroll Control] key are invalid. (Of course, [Func] + [ /  / 

Pressing any other key causes the scanner displays "Keypad Lock" and "On" and does not sound any beep.



KEY SAFE MODE

This mode prevents accidentally changing parameter or modes. This mode is for handing the scanner to someone unfamiliar with its operation.

Some keys don't work in this mode.

Changed Key Operation in Key Safe Mode

The key in which a setting is applied showed in the following table.

		Scan	Service Search	Custom Search	Quick Search	WX	Close Call	Tone-Out	GPS	Band Scope
Normal Mode	Scan / srch		O ^{*1}	O ^{*1}	O ^{*1}	O	O	O	O	O
	Hold / 						O			
	L/O	O ^{*2}	O ^{*2}	O ^{*2}	O ^{*2}		O ^{*2,4}		O ^{*2}	
	1 - 3 / sr1 - 3									
	4 / LEFT / ifx									
	5 / lvl									
	6/RIGHT/ disp									
	7 / att									
	8 / rev									
	9 / mod									
	0 / wx									
	. / no / pri									
	E / yes / gps	O	O	O	O	O	O	O	O	O
Menu	O	O	O	O	O	O	O	O	O	
Function Mode	Scan / srch	O				O	O	O	O	
	Hold / 	O ^{*4}	O ^{*4}	O ^{*4}	O ^{*4}	O ^{*4}	O ^{*4}	O ^{*4}		O ^{*4}
	L/O		O	O	O		O			
	1 - 3 / sr1 - 3	O ^{*5}	O	O	O	O	O	O		O
	4 / LEFT / ifx	O ^{*5}	O ^{*3}	O ^{*3}	O ^{*3}	O ^{*3}	O ^{*3}	O		O
	5 / lvl	O ^{*5}								
	6/RIGHT/ disp									
	7 / att	O ^{*5}	O	O	O	O	O	O		O
	8 / rev									
	9 / mod	O ^{*5}	O	O	O		O	O		O
	0 / wx	O ^{*4,5}	O ^{*4}	O ^{*4}	O ^{*4}	O	O ^{*4}	O ^{*4}		O ^{*4}
	. / no / pri									
	E / yes / gps	O	O	O	O	O	O	O	O	O
Menu	O	O	O	O	O	O	O	O	O	

*1 This key works as RESUME key in search hold mode.

*2 You can control temporary L/O and unlock permanent L/O.

*3 This function is applied in hold mode or monitoring a transmission.

*4 Long press of this key does not work.

*5 This function is applied only in hold mode.

Key Safe Operation

Turns on power while pressing and holding [FUNC] key to go to the LAST MODE* in Key Safe Mode.

The scanner displays the “Key Safe Mode On” message after displaying the copyright message.

In Key Safe Mode, the on power supply while pressing and holding [FUNC] key to return to LAST MODE* in Full Operation. The scanner displays the “Key Safe Mode Off” message after displaying the copyright message.

If you try to set this function and Startup Key Operation together by pressing and holding [FUNC] key and the number key, the scanner does not set Key Safe Operation.

LAST MODE means the mode when the scanner is turned off. It resumes Scan Mode, Custom/Service/Quick Search Mode, Weather Mode, Close Call Only, Tone-Out Mode, each Hold Mode, GPS Mode and Band Scope Mode for LAST MODE.

In ID Search Hold Mode if ID has already been registered, LAST MODE will be ID Search Hold Mode. If ID has not been registered yet, LAST MODE will be Scan Mode.

Review Location Mode is set to normal Scanner Mode (not GPS Mode).

Key Safe Message

If you try to change a parameter or change to another mode, the scanner displays the following message and sounds an Error Tone.

```
Key Safe Mode
Press FUNC while
Power On for
Full Operation
```

MEMORY INITIALIZATION

Press and hold [2 / sr 2], [9 / mod] and [Hold / 

The scanner clears all data and returns to initial setting. The display is as follows.

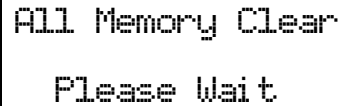

```
All Memory Clear
Please Wait
```

*If you unplug the AC Adapter or turn off the scanner during initialization, the scanner starts initializing again at next power on.

After clearing data, the scanner displays "Restore Preprogram List? Yes = "E" / No = "." " then you can select whether to restore the Preprogram List.

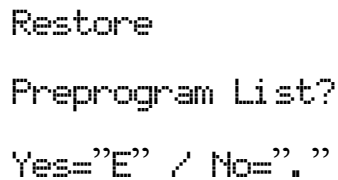

```
Restore
Preprogram List?
Yes="E" / No="."
```

Press [E / yes / gps] to restore the Preprogram List. Or, pressing [no / pri] to use without restoring the Preprogram List.

Then other keys are invalid and do not ring Key Beep.

If you press [E / yes / gps], the display is as follows.

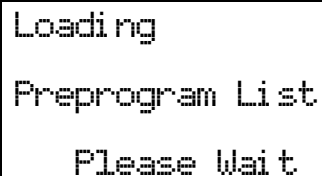

```
Loading
Preprogram List
Please Wait
```

BATTERY CHARGE

Battery Type Select

You can power the scanner non-rechargeable batteries (not supplied), nickel metal hydride (Ni-MH) rechargeable batteries or AC adapter.

You need to select the battery type before using batteries.

Turn off the scanner and remove the battery compartment cover. There is a switch to select the battery type like the following figure.

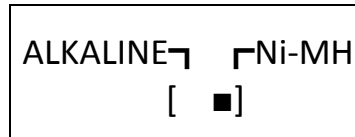

Set the switch to " Ni-MH " only if you are using Ni-MH batteries.

Set the switch to " ALKALINE " if you are using non-rechargeable batteries.

The scanner has a built-in circuit that charges the Ni-MH batteries.

To charge the batteries, connect the AC adapter to the scanner's power jack after installing the Ni-MH batteries with correct setting of the battery type switch.

The scanner charges the installed Ni-MH batteries. You can change the charging time.(See: [Set Charge Time](#))

*Never use non-rechargeable batteries in the scanner with the switch set to Ni-MH.

Charging the Battery

If an AC adapter is connected to the scanner, or a battery is installed to the scanner when an AC adapter is connected, the scanner will check the battery condition.

When the scanner is turned off:

If the battery is a rechargeable one, the scanner charges the battery.

The scanner displays "Normal Charging" while charging the battery.

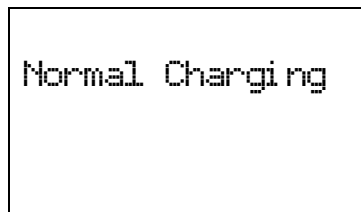

When the scanner charges the battery, it steps up the voltage gradually.

The scanner displays "Pre-Charging". "Pre-Charging" is a transition to the beginning of "Normal Charging".

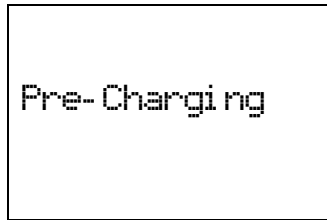

Pre-Charging

When the charge time elapses, it displays "Charge Complete".



Charge Complete

If a battery is not installed, it displays "No Battery".



No Battery

If the scanner detects that the battery cannot be charged, it displays "Battery Error".

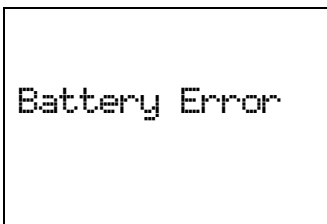

Battery Error

If there is a battery and Battery Type of the scanner is set to ALKALINE, it displays "Charge Off".

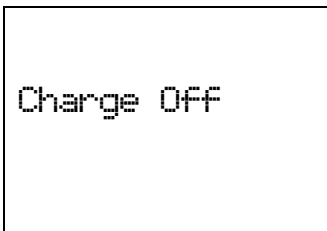

Charge Off

If the scanner detects an illegal voltage (voltage outside the allowable range), it displays "Illegal Voltage" and you cannot turn on power.

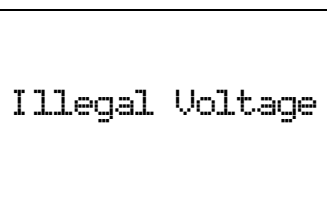

Illegal Voltage

When the scanner is turned on:

If the battery is good, the scanner charges the battery and it operates ordinarily. When the scanner cannot judge the battery to be a good one at once, the scanner checks the battery and the battery icon is displayed.

If the scanner judges the battery good, the scanner starts charging and the battery icon disappears.

If it cannot regard the battery as good within 60 seconds, the scanner stops checking and the battery icon blinks.

OTHERS

AVAILABLE SYSTEM SETTINGS

Different types of systems and sites have different settings available.

*In the following table, "CNV" means Conventional System.

System Settings

System Settings	CNV*	MOT	EDACS		LTR
			WIDE / NARROW	SCAT	
Edit Name	0	0	0	0	0
Edit Sys Option	0	0	0	0	0
Edit Site	---	0	0	0	0
Edit Group	0	0	0	---	0
Copy System	0	0	0	0	0
Delete System	0	0	0	0	0

System Option Settings

System Option Settings	CNV*	MOT	EDACS		LTR
			WIDE / NARROW	SCAT	
Set Quick Key	0	---	---	---	---
Set Startup Key	0	---	---	---	---
Set Number tag	0	0	0	0	0
Set Lockout	0	---	---	---	---
Set Hold Time	0	---	---	---	---
ID Scan/Search	---	0	0	---	0
Set Delay Time	0	0	0	0	0
Edit Fleet Map	---	0	---	---	---
Priority ID Scan	---	0	0	---	0
Set Status Bit	---	0	---	---	---
Set End Code	---	0	---	---	---
Emergency Alert	---	0	0	---	---
Set ID Format (DEC/HEX)	---	0	---	---	---
Set ID Format (AFS/DEC)	---	---	0	---	---
Rvw ID:Srch L/O	---	0	0	---	0
Clr All L/O IDs	---	0	0	---	0

Site Settings

Site Setting	MOT	EDACS		LTR
		WIDE / NARROW	SCAT	
Edit Name	0	0	---	0
Set Quick Key	0	0	0	0
Set Startup Key	0	0	0	0
Edit Band Plan	0	---	---	---
Set Site Type	---	0	---	---
Set Frequencies	0	0	0	0
Set Modulation	0	0	0	0
Set Attenuator	0	0	0	0
Set Lockout	0	0	0	0
Set Hold Time	0	0	0	0
Set LocationInfo	0	0	0	0
Delete Site	0	0	---	0
New Site	0	0	---	0

Site Frequency Settings

Site Frequency	MOT	EDACS		LTR
		WIDE / NARROW	SCAT	
Edit Frequency	0	0	0	0
Input LCN	---	0	---	0
Set Number tag	---	---	0	---
Set Lockout	0	0	0	0
Volume Offset	---	---	0	---
Delete Frequency	0	0	0	0
New Frequency	0	0	0	0

Channel Settings

Channel Settings	CNV*	MOT	EDACS		LTR
			WIDE / NARROW	SCAT	
Edit Name	0	0	0	---	0
Edit Frequency	0	---	---	---	---
Edit TGID	---	0	0	---	0
Set CTCSS/DCS	0	---	---	---	---
Set Number tag	0	0	0	---	0
Set Modulation	0	---	---	---	---
Set Attenuator	0	---	---	---	---
Set Priority	0	0	0	---	0
Set Alert	0	0	0	---	0
Set Lockout	0	0	0	---	0
Volume Offset	0	0	0	---	0
Copy Channel	0	0	0	---	0
Delete Channel	0	0	0	---	0
New Channel	0	0	0	---	0

TGID FORMAT FOR TRUNKED SYSTEM

[MOTOROLA TYPE1 SYSTEM]

Display Format

- | | |
|-----------|--|
| 1) BFF-SS | Normal ID
B is 1 digit
FF is 2 digits (0 filling)
SS is 1-2 digit(s) |
| 2) BFFF-S | Normal ID (when FLEET is 100-127)
B is 1 digit
FFF is 3 digits
S is 1 digit |
| 3) B---- | Partial ID (free FLEET and SUB-FLEET)
B is 1 digit |
| 4) BFF--- | Partial ID (free SUB-FLEET)
B is 1 digit
FF is 2 digits (0 filling) |
| 5) BFFF-- | Partial ID (free SUB-FLEET when FLEET is 100-127)
B is 1 digit
FFF is 3 digits |
| 6) NNNNN | Normal ID when SIZE CODE is 0
N is 1-5 digit(s) |
| 7) iNNNNN | I-CALL ID
N is 5 digits (0 filling) |

Input Format

- | | |
|-----------|---|
| 1) BFF-SS | Normal ID
B is 1 digit
FF should be 2 digits (0 filling)
SS is 1-2 digit(s) |
| 2) BFFF-S | Normal ID (when FLEET is 100-127)
B is 1 digit
FFF is 3 digits
S is 1 digit |
| 3) B- | Partial ID (free FLEET and SUB-FLEET)
B is 1 digit |
| 4) BFF- | Partial ID (fleet SUB-FLEET)
B is 1 digit
FF should be 2 digits (0 filling) |
| 5) BFFF- | Partial ID (fleet SUB-FLEET when FLEET is 100-127)
B is 1 digit
FFF is 3 digits |
| 6) NNNNN | Normal ID when SIZE CODE is 0
N is 1-5 digit(s) |
| 7) iNNNNN | I-CALL ID
N is 1-5 digit(s) |

Range

B : BLOCK (0-7)
FF(F) : FLEET
S(S) : SUB-FLEET

FLEET and SUB-FLEET maximum numbers depend on the SIZE CODE of each BLOCK in FLEET-MAP setting.

SIZE CODE 0:BLOCK0 : NNNNN (0- 8191)
BLOCK1 : NNNNN (8192-16383)
BLOCK2 : NNNNN (16384-24575)
BLOCK3 : NNNNN (24576-32767)
BLOCK4 : NNNNN (32768-40959)
BLOCK5 : NNNNN (40960-49151)
BLOCK6 : NNNNN (49152-57343)
BLOCK7 : NNNNN (57344-65535)
SIZE CODE 1 : FLEET (00-127) SUB-FLEET (0-3)
SIZE CODE 2 : FLEET (00-15) SUB-FLEET (0-7)
SIZE CODE 3 : FLEET (00-07) SUB-FLEET (0-7)
SIZE CODE 4 : FLEET (00) SUB-FLEET (0-15)
SIZE CODE 5 : FLEET (00-63) SUB-FLEET (0-3)
SIZE CODE 6 : FLEET (00-31) SUB-FLEET (0-7)
SIZE CODE 7 : FLEET (00-31) SUB-FLEET (0-3)
SIZE CODE 8 : FLEET (00-15) SUB-FLEET (0-3)
SIZE CODE 9 : FLEET (00-07) SUB-FLEET (0-3)
SIZE CODE 10 : FLEET (00-03) SUB-FLEET (0-7)
SIZE CODE 11 : FLEET (00-01) SUB-FLEET (0-15)
SIZE CODE 12 : FLEET (00) SUB-FLEET (0-15)
SIZE CODE 13 : FLEET (00) SUB-FLEET (0-15)
SIZE CODE 14 : FLEET (00) SUB-FLEET (0-15)

I-CALL ID : i00000-i65535

Note

The display format is also valid in remote command input.

[MOTOROLA TYPE2 SYSTEM]

<Decimal Format>

Display Format

- | | |
|-----------|-------------------------------|
| 1) NNNNN | Normal ID |
| | NNNNN is 1-5 digit(s) |
| 2) iNNNNN | I-CALL ID |
| | NNNNN is 5 digits (0 filling) |

Input Format

- | | |
|-----------|-----------------------|
| 1) NNNNN | Normal ID |
| | NNNNN is 1-5 digit(s) |
| 2) iNNNNN | I-CALL ID |
| | NNNNN is 1-5 digits. |

Range

Normal ID : 1-65535
I-CALL ID : i00000-i65535

Note

TYPE2 format cannot support PARTIAL ID.

<Hexadecimal Format>

Display Format

- | | |
|-----------|------------------------------|
| 1) NNNh | Normal ID |
| | NNN is 1-3 digit(s) |
| 2) iNNNNh | I-CALL ID |
| | NNNN is 4 digits (0 filling) |

Input Format

- | | |
|----------|---------------------|
| 1) NNN | Normal ID |
| | NNN is 1-3 digit(s) |
| 2) iNNNN | I-CALL ID |
| | NNNN is 1-4 digits. |

Range

Normal ID : 001 – FFF
I-CALL ID : i0000 – iFFFF

Note

TYPE2 format cannot support PARTIAL ID.
Normal ID: Hexadecimal Format omits lower 4 bit
Ex)
001h (Hex) -> 0016 (Dec)

[EDACS SYSTEM]

<AFS format>

Display Format

- | | |
|-----------|---------------------------------------|
| 1) AA-FFS | Normal ID |
| | AA is 2 digits (0 filling) |
| | FF is 2 digits (0 filling) |
| | S is 1 digit |
| 2) AA---- | Partial ID (free FLEET and SUB-FLEET) |
| | AA is 2 digits (0 filling) |
| 3) AA-FF- | Partial ID (free SUB-FLEET) |
| | AA is 2 digits (0 filling) |
| | FF is 2 digits (0 filling) |

Input Format

- | | |
|-----------|---------------------------------------|
| 1) AA-FFS | Normal ID |
| | AA should be 2 digits (0 filling) |
| | FF should be 2 digits (0 filling) |
| | S should be 1 digit |
| 2) AA- | Partial ID (free FLEET and SUB-FLEET) |
| | AA should be 2 digits (0 filling) |
| 3) AA-FF | Partial ID (free SUB-FLEET) |
| | AA should be 2 digits (0 filling) |
| | FF should be 2 digits (0 filling) |

Range

- | | |
|---------------|---------------------------|
| AA : AGENCY | 2digits (00-15) |
| FF : FLEET | 2digits (00-15) |
| S : SUB-FLEET | 1digit (0-7) |
| | *ALL0(00-00-0) is invalid |

Note

- Both AFS and Decimal Format are valid to input regardless of AFS setting.
- Display Format depends on AFS/Decimal setting except for I-CALL ID.
- Use Decimal format when I-CALL is needed.
- I-CALL format is always shown in Decimal Format regardless of AFS setting.
- AFS format cannot support I-CALL ID format.
- Display Format is also valid in remote command input.

<Decimal format>

Display Format

- | | |
|-----------|-------------------------------------|
| 1) NNNN | Normal ID |
| | NNNN is 1-4 digit(s) (no 0 filling) |
| 2) iNNNNN | I-CALL ID |
| | NNNNN is 5 digits (0 filling) |

Input Format

- | | |
|-----------|-----------------------|
| 1) NNNN | Normal ID |
| | NNNN is 1-4 digit(s) |
| 2) iNNNNN | I-CALL ID |
| | NNNNN is 1-5 digit(s) |

Range

Normal ID : 1-2047
I-CALL ID : i00000-i16383

Note

- Both AFS and Decimal Format are valid to input regardless of AFS setting.
- Display Format depends on AFS/Decimal Setting except for I-CALL ID.
- I-CALL format is always showed as Decimal Format regardless of AFS setting.
- Decimal format cannot support Partial ID.

[LTR SYSTEM]

Display Format

- 1) A-RR-NNN Normal ID
 A is 1 digit
 RR is 2 digits
 NNN is 3 digits
- 2) A-RR---- Partial ID
 A is 1 digit
 RR is 2 digits

Input Format

- 1) A-RR-NNN Normal ID
 A is 1 digit
 RR is 2 digits
 NNN is 3 digits
- 2) ARRNNN Normal ID (Easy Way)
 A is 1 digit
 RR should be 2 digits (01-20)
 NNN should be 3 digits (000-254)
- 3) A-RR Partial ID (free ID)
 A is 1 digit
 RR should be 2 digits (01-20)

Range

- A : AREA CODE 1digit (0 or 1)
- RR : HOME REPEATER 2digit (01-20)
- NNN : ID 3digit (000-254)

Note

LTR System has no I-CALL ID.

FLEET MAP

The range of TGIDs is from 0 to 65535. This range is split into 8 equal blocks, and each Block is set to one of 15 Size Codes.

The range of TGID	0 - 65535
Block 0	0 - 8191
Block 1	8192 - 16383
Block 2	16384 - 24575
Block 3	24576 - 32767
Block 4	32768 - 40959
Block 5	40960 - 49151
Block 6	49152 - 57343
Block 7	57344 - 65535

Size Code from 0 to 11 uses 1 Block, 12+ occupies multiple blocks.

"**Size Code 12**" occupies 2 Blocks and this can be set to even Block numbers. If you try to set this to an odd Block number, it is set to the previous Block number.

The Block after the one you set to "Size Code 12" is also treated as "Size Code 12". This number does not appear in the Block selection.

For example, if you try to set Size Code 12 to Block 3, it is set to Block 2. Then the Block 3 is skipped because Block 2 is set to "Size Code 12". Block 2 and Block 3 are treated as "Size Code 12". Then the scanner advances to Block 4 to select its Size Code.

"**Size Code 13**" occupies 4 Blocks and this can be set only for Block 0 or Block 4. If you try to set this to Block number 1 - 3, it is set to Block 0. And if you try to set this to Block number 5 - 7, it is set to Block 4.

When you set a block to "Size Code 13", the following three blocks are also be treated as "Size Code 13".

The "**Size Code 14**" occupies all 8 Blocks. So, this Size Code can only be set for Block 0. If you try to set this to another Block, it is set to Block 0. Then only the Block 0 is displayed. All Blocks are treated as "Size Code 14".

If you change a Size Code from these 3 Codes to a Size Code which occupies a fewer number of Block, the scanner sets the other Blocks to "Size Code 0".

For example, if you changes the Block 0 from "Size Code 13" to "Size Code 5", the setting of Blocks are: Block 0 = Size Code 5, Block 1 - 3 = Size Code 0.

Details of each Size Code are as follows.

Size Code	Fleet-SubFleet-ID	Number of Blocks occupied
0	(as Type II ID)	1
1	128-4-16	1
2	16-8-64	1
3	8-8-128	1
4	1-16-512	1
5	64-4-32	1
6	32-8-32	1
7	32-4-64	1
8	16-4-128	1
9	8-4-256	1
10	4-8-256	1
11	2-16-256	1
12	1-16-1024	2
13	1-16-2048	4
14	1-16-4096	8

*The numbers of "Fleet-SubFleet-ID" means the number of each. If the number of Fleets is 4, there are 4 Fleets and the range is from 0 to 3.

PRESET FLEET MAPS

*The numbers in the table shows the number of SIZE CODE.

BLOCK No.	0	1	2	3	4	5	6	7
Preset 1	11	11	11	11	11	11	11	11
Preset 2	4	4	4	4	4	4	4	4
Preset 3	4	4	4	4	4	4	12	(12)
Preset 4	12	(12)	4	4	4	4	4	4
Preset 5	4	4	12	(12)	4	4	4	4
Preset 6	3	10	4	4	12	(12)	12	(12)
Preset 7	10	10	11	4	4	4	4	4
Preset 8	1	1	2	2	3	3	4	4
Preset 9	4	4	0	0	0	0	0	0
Preset 10	0	0	0	0	0	0	4	4
Preset 11	4	0	0	0	0	0	0	0
Preset 12	0	0	0	0	0	0	0	4
Preset 13	3	3	11	4	4	0	0	0
Preset 14	4	3	10	4	4	4	12	(12)
Preset 15	4	4	4	11	11	0	12	(12)
Preset 16	3	10	10	11	0	0	12	(12)

WEATHER CHANNELS

The modulation for all Weather Channels is FM.

CH No.	Frequency
1	162.5500 MHz
2	162.4000 MHz
3	162.4750 MHz
4	162.4250 MHz
5	162.4500 MHz
6	162.5000 MHz
7	162.5250 MHz
8	161.6500 MHz
9	161.7750 MHz
10	163.2750 MHz

CTCSS FREQUENCY

The scanner can detect the following 50 CTCSS frequencies.

67.0Hz	88.5Hz	114.8Hz	151.4Hz	177.3Hz	203.5Hz	250.3Hz
69.3Hz	91.5Hz	118.8Hz	156.7Hz	179.9Hz	206.5Hz	254.1Hz
71.9Hz	94.8Hz	123.0Hz	159.8Hz	183.5Hz	210.7Hz	
74.4Hz	97.4Hz	127.3Hz	162.2Hz	186.2Hz	218.1Hz	
77.0Hz	100.0Hz	131.8Hz	165.5Hz	189.9Hz	225.7Hz	
79.7Hz	103.5Hz	136.5Hz	167.9Hz	192.8Hz	229.1Hz	
82.5Hz	107.2Hz	141.3Hz	171.3Hz	196.6Hz	233.6Hz	
85.4Hz	110.9Hz	146.2Hz	173.8Hz	199.5Hz	241.8Hz	

DCS CODE

The scanner can detect the following 104 hexadecimal DCS codes.

023	051	114	143	174	245	266	332	411	452	506	612	703
025	053	115	145	205	246	271	343	412	454	516	624	712
026	054	116	152	212	251	274	346	413	455	523	627	723
031	065	122	155	223	252	306	351	423	462	526	631	731
032	071	125	156	225	255	311	356	431	464	532	632	732
036	072	131	162	226	261	315	364	432	465	546	654	734
043	073	132	165	243	263	325	365	445	466	565	662	743
047	074	134	172	244	265	331	371	446	503	606	664	754

CEA2009-SAME EVENT CODE(ANSI/CEA-2009-A October 2005)

Standard	Event Code	EVENT LEVEL			LCD Display
		Warning			
		Watch	Advisory		
ADR	Administrative Message			O	Admin Message
AVA	Avalanche Watch		O		Avalanche
AVW	Avalanche Warning	O			Avalanche
BHW	Biological Hazard Warning	O			Biological
BWW	Boil Water Warning	O			Boil Water
BZW	Blizzard Warning	O			Blizzard
CAE	Child Abduction Emergency			O	Child Emergency
CDW	Civil Danger Warning	O			Civil Danger
CEM	Civil Emergency Message	O			Civil EMG
CFA	Coastal Flood Watch		O		Coastal Flood
CFW	Coastal Flood Warning	O			Coastal Flood
CHW	Chemical Hazard Warning	O			Chemical
CWW	Contaminated Water Warning	O			Contam. Water
DBA	Dam Watch		O		Dam Break
DBW	Dam Break Warning	O			Dam Break
DEW	Contagious Disease Warning	O			Contagious
DMO	Practice/Demo			O	System Demo
DSW	Dust Storm Warning	O			Dust Storm
EAN	Emergency Action Notification	O			EMG Notify
EAT	Emergency Action Termination			O	EMG Terminate
EQW	Earthquake Warning	O			Earthquake
EVA	Evacuation Watch		O		Evacuate Note
EVI	Immediate Evacuation	O			Evacuate Note
FCW	Food Contamination Warning	O			Food
FFA	Flash Flood Watch		O		Flash Flood
FFS	Flash Flood Statement			O	Flash Flood
FFW	Flash Flood Warning	O			Flash Flood
FLA	Flood Watch		O		Flood
FLS	Flood Statement			O	Flood
FLW	Flood Warning	O			Flood
FRW	Fire Warning	O			Fire
FSW	Flash Freeze Warning	O			Flash Freeze
FZW	Freeze Warning	O			Freeze
HLS	Hurricane Statement			O	Hurricane
HMW	Hazardous Material Warning	O			Hazardous
HUA	Hurricane Watch		O		Hurricane
HUW	Hurricane Warning	O			Hurricane
HWA	High Wind Watch		O		High Wind
HWW	High Wind Warning	O			High Wind

IBW	Iceberg Warning	O			Iceberg
IFW	Industrial Fire Warning	O			Industrial Fire
LAE	Local Area Emergency			O	Local EMG
LEW	Law Enforcement Warning	O			Law Enforcement
LSW	Land Slide Warning	O			Land Slide
NAT	National Audible Test			O	National Audible
NIC	National Information Center			O	National Info
NMN	Network Notification Message			O	Network Message
NPT	National Periodic Test			O	Nation Period
NST	National Silent Test			O	Nation Silent
NUW	Nuclear Power Plant Warning	O			Nuclear Plant
POS	Power Outage Advisory			O	Power Outage
RHW	Radiological Hazard Warning	O			Radiological
RMT	Required Monthly Test			O	Monthly
RWT	Required Weekly Test			O	Weekly
SMW	Special Marine Warning	O			Special Marine
SPS	Special Weather Statement			O	Special WX
SPW	Shelter In-Place Warning	O			Shelter
SVA	Severe Thunderstorm Watch		O		Thunderstorm
SVR	Severe Thunderstorm Warning	O			Thunderstorm
SVS	Severe Weather Statement			O	Severe WX
TOA	Tornado Watch		O		Tornado
TOE	911 Telephone Outage Emergency			O	911 Phone Outage
TOR	Tornado Warning	O			Tornado
TRA	Tropical Storm Watch		O		Tropical Storm
TRW	Tropical Storm Warning	O			Tropical Storm
TSA	Tsunami Watch		O		Tsunami
TSW	Tsunami Warning	O			Tsunami
TXB	Transmitter Backup On			O	TX Backup On
TXF	Transmitter Carrier Off			O	TX Carrier Off
TXO	Transmitter Carrier On			O	TX Carrier On
TXP	Transmitter Primary On			O	TX Primary On
VOW	Volcano Warning	O			Volcano
WFA	Wild Fire Watch		O		Wild Fire
WFW	Wild Fire Warning	O			Wild Fire
WSA	Winter Storm Watch		O		Winter Storm
WSW	Winter Storm Warning	O			Winter Storm
**A	Unrecognized Watch		O		Unrecognized
**E	Unrecognized Emergency			O	Unrecognized
**S	Unrecognized Statement			O	Unrecognized
**W	Unrecognized Warning	O			Unrecognized

REMOTE COMMAND

【 Remote Communication Format 】

BPS rate : 4800/9600/19200/38400/57600/115200 bps
Start/Stop bit : 1 bit, 1 bit
Data Length : 8 bit
Parity Check : None
Code : ASCII
Flow Control : None
Return Code : Carriage Return only

【 FORMAT OF THIS DOCUMENT 】

<COMMAND NAME>

Summary explanation of the function of the command

Controller → Radio

Command format

Radio → Controller

Response format

NOTE

1. Commands are required to wait a response from the scanner, then, next command is accepted.
2. All memory access commands are acceptable in only Program Mode.
Use PRG command to enter Program Mode, and EPG command to exit.
3. Error messages aren't described for each command, but the scanner returns error message to the controller as follows.
 - 1) Command format error / Value error : ERR[\r]
 - 2) The command is invalid at the time : NG[\r]
 - 3) Framing error : FER[\r]
 - 4) Overrun error : ORER[\r]
4. [\r] means "to hit the Enter key" or "to send the Return code".
5. Several commands or responses with long format are described like multi-line because of the page width but their formats are only single line, actually.
In set command, only "," parameters are not changed.
6. The set command is aborted if any format error is detected.
7. [INDEX] or [xxx_INDEX] is the index of internal memory chain.
Dynamic Memory Allocation Structure always uses it as a handle to access data and to trace forward/reverse or up/down index.
The range of the index is from 1 to maximum memory block (about 45000).
8. [FRQ], [BASEx] and [LIMIT_x] are frequency format.
It is showed by 8 digit number without decimal point.
The order of the digits is from 1 GHz digit to 100 Hz digit.
ex. 08510125 means 851.0125MHz
9. [TGID] shows TGID format. The formats depend on Trunked System Type.
See another Appendix to get further information.
10. [NAME] shows each custom name. If you set only a space character, the name will return to default name.
11. [LATITUDE] shows North or South Latitude.
The data shows "DDMMSSsL" at DMS Format.

DD	:	Degree	(00 - 90 : Double figure fixation)
MM	:	Minute	(00 - 59 : Double figure fixation)
SSss	:	Second	(SS : 00 - 59 : Double figure fixation)

(ss : 00 - 99 : Double figure fixation)
 L : Bearing (N : North / S : South)
 ex) "North Latitude 40°42'51.12" shows "40425112N".

12. [LONGITUDE] shows West or East Longitude.

The data shows "DDMMSSssL" at DMS Format.

DDD : Degree (000 - 180 : Triple figure fixation)
 MM : Minute (00 - 59 : Double figure fixation)
 SSss : Second (SS : 00 - 59 : Double figure fixation)
 (ss : 00 - 99 : Double figure fixation)
 L : Bearing (W : West / E : East)
 ex) "West Longitude 74°00'23.05" shows "074002305W".

Remote Command List

No.	Category	Command	Function	Program Mode Only
	Remote Control	GID	Get Current TalkGroup ID Status	
		KEY	Push KEY	
		POF	Power Off	
		QSH	Go to quick search hold mode	
		QSC	Set current frequency and get reception status	
		CSC	Go to Custom search and get reception status	
		PWR	Get RSSI Level	
		STS	Get Current Status	
		GLG	Get Reception Status	
		JPM	Jump Mode	
		JNT	Jump to Number Tag	
		MNU	Menu Mode	
		System Information	MDL	Get Model Info
	VER		Get Firmware Version	
	Program Control Mode	PRG	Enter Program Mode	
		EPG	Exit Program Mode	
	System Settings	BLT	Get/Set Backlight	0
		BSV	Get/Set Battery Info	0
		COM	Get/Set COM port setting	0
		CLR	Clear All Memory	0
		KBP	Get/Set Key Beep and setting	0
		OMS	Get/Set Opening Message	0
		PRI	Get/Set Priority Mode	0
		AGV	Get/Set Auto Gain Control	0
		SCT	Get System Count	0
	Scan Settings	SIH	Get System Index Head	0
		SIT	Get System Index Tail	0
		QSL	Get/Set System/Site Quick Lockout	0
		QGL	Get/Set Group Quick Lockout	0

		CSY	Create System	0
		DSY	Delete System	0
		SIN	Get/Set System Info	0
		TRN	Get/Set Trunk Info	0
		AST	Append Site	0
		SIF	Get/Set Site Info	0
		MCP	Get/Set Motorola Custom Band Plan	0
		TFQ	Get/Set Trunk Frequency Info	0
		AGC	Append Channel Group	0
		AGT	Append TalkGroup ID Group	0
		DGR	Delete Group / Site	0
		GIN	Get/Set Group Info	0
		ACC	Append Channel / Trunk Frequency	0
		ACT	Append TalkGroup ID	0
		DCH	Delete Channel	0
		CIN	Get/Set Channel Info	0
		TIN	Get/Set TalkGroup ID Info	0
		GLI	Get Lockout TalkGroup ID (for Rvw L/O ID)	0
		SLI	Get Search L/O TalkGroup ID	0
		ULI	Unlock TalkGroup ID (for Rvw L/O ID)	0
		LOI	Lockout ID (TalkGroup ID)	0
		REV	Get Rev Index	0
		FWD	Get Fwd Index	0
		RMB	Get Remains of Memory Block	0
		MEM	Get Memory Used	0
	Location Setting	LIH	Get Location Alert System Index Head	0
		LIT	Get Location Alert System Index Tail	0
		CLA	Create Location Alert System	0
		DLA	Delete Location Alert System	0
		LIN	Get/Set Location Alert System Info	0
	Search / Close Call Settings	SCO	Get/Set Search/Close Call Settings	0
		BBS	Get/Set Broadcast Screen Band Settings	0
		SHK	Get / Set Search Key Settings	0
		GLF	Get Global Lockout Freq	0
		ULF	Unlock Global L/O	0
		LOF	Lock Out Frequency	0
		CLC	Get/Set Close Call Settings	0
	Service Search Settings	SSP	Get/Set Service Search Settings	0
	Custom Search Settings	CSG	Get/Set Custom Search Group	0
		CBP	Get/Set C-Ch Only Custom search MOT Band Plan	0
		CSP	Get/Set Custom Search Settings	0
	Weather Settings	WXS	Get/Set Weather Settings	0
		SGP	Get/Set SAME Group Settings	0
	Tone-Out Setting	TON	Get/Set Tone-Out Settings	0
	LCD Contrast Settings	CNT	Get/Set LCD Contrast Settings	0
	Scanner Option Settings	SCN	Get/Set Scanner Option Settings	0
	Volume Level Settings	VOL	Get/Set Volume Level Settings	

	Squelch Level Settings	SQL	Get/Set Squelch Level Settings	
	Default Band Coverage Settings	DBC	Get/Set Default Band Coverage Settings	0
	GPS Settings	GDO	Get/Set GPS Format	0
	Band Scope Settings	BSP	Get/Set Band Scope Settings	0
	IF exchange list Settings	GIE	Get Global IF exchange Frequency	0
		CIE	Clear IF exchange Frequency	0
		RIE	Register IF exchange Frequency	0
	TEST	BAV	Get Battery Voltage	
		WIN	Get Window Voltage	

<COMMAND GID>
Get Current TGID Status
Controller → Radio
GID[\r]
Radio → Controller
GID, [SITE_TYPE], [TGID], [ID_SRCH_MODE], [NAME1], [NAME2], [NAME3] [\r]

[SITE_TYPE] : Site Type
CNV : CONVENTIONAL system site
MOT : MOTOROLA system site
EDC : EDACS Narrow / Wide system site
EDS : EDACS SCAT system site
LTR : LTR system site

[TGID] : TGID
[ID_SRCH_MODE] : ID SCAN / ID SEARCH Mode
0:ID SCAN Mode / 1:ID SEARCH Mode)
[NAME1] : SYSTEM / SITE NAME (Alpha Tag)
[NAME2] : GROUP NAME (Alpha Tag)
[NAME3] : TGID NAME (Alpha Tag)

FUNCTION

This command return TGID currently displayed on LCD.
If you get the TGID once, the scanner returns , , , , , [\r] until next reception.

NOTE :

This command return , , , , , [\r], when TGID is not displayed.

<COMMAND KEY>

Push KEY

Controller → Radio

KEY, [KEY_CODE], [KEY_MODE] [\r]

Radio → Controller

KEY,OK[\r]

[KEY_CODE]	M	:	MENU
	F	:	FUNC
	H	:	HOLD
	S	:	SCAN/SEARCH
	L	:	L/O
	1	:	1
	2	:	2
	3	:	3
	4	:	4
	5	:	5
	6	:	6
	7	:	7
	8	:	8
	9	:	9
	0	:	0
	.	(dot)	: ./NO
	E	:	E/YES
	>	:	VFO RIGHT * Set "P" to KEY_MODE.
	<	:	VFO LEFT * Set "P" to KEY_MODE.
	^	:	VFO PUSH
	P	:	POWER/LIGHT/LOCK

[KEY_MODE]	P	:	Press
	L	:	Long Press
	H	:	Hold (Press and Hold until Release receive)
	R	:	Release (Cancel Hold state)

Ex.1) Press MENU KEY

→ KEY,M,P[\r]

← OK[\r]

Ex.2) Press F + SCAN KEY

→ KEY,F,P[\r] : Hold F KEY

← OK[\r]

→ KEY,S,P[\r] : Press SCAN KEY (F + SCAN KEY operation)

← OK[\r]

→ KEY,F,P[\r] : Release F KEY

→ OK[\r]

Ex.3) Press and Hold L/O KEY

→ KEY,L,L[\r]

← OK[\r]

The status of KEY HOLD does time-out in 10 seconds after having received the command of KEY HOLD when there is not communication. (For example, "KEY,F,H".)

```

<COMMAND POF>
  Power OFF
  Controller → Radio
POF[\r]
  Radio → Controller
POF,OK[\r]

```

Turns off the scanner.
 After this command, the scanner doesn't accept any command.

```

<COMMAND QSH>
  Go to quick search hold mode
  Controller → Radio
QSH, [FRQ], [RSV], [MOD], [ATT], [DLY], [RSV], [CODE_SRCH], [BSC], [REP], [RSV],
[RSV], [RSV], [RSV] [\r]
  Radio → Controller
QSH,OK[\r] or QSH,NG[\r]

```

```

[FRQ]           : Frequency (The right frequency)
[MOD]           : Modulation      (AUTO/AM/FM/NFM/WFM/FMB)
[ATT]           : Attenuation     (0:OFF / 1:ON)
[DLY]           : Delay Time      (-10,-5,-2,0,1,2,5,10,30)
[CODE_SRCH]     : CTCSS/DCS Search
                 (0:OFF / 1: CTCSS/DCS)
[BSC]           : Broadcast Screen (16digit: #####.##)
                 (each # is 0 or 1)
                 0 means OFF
                 1 means ON
[REP]           : Repeater Find   (0:OFF / 1:ON)
[RSV]           : Reserve Parameter * This is always only ",".

```

	··+-	Band10
		:
	+-----	Band 2
	+-----	Band 1
	+-----	Reserve
	+-----	NOAA WX
	+-----	VHF TV
	+-----	UHF TV
	+-----	FM
	+-----	Pager

This command is invalid when the scanner is in Menu Mode, during Direct Entry operation, during Quick Save operation.

FUNCTION

UASD specifies arbitrary frequency and changes to Quick Search Hold (VFO) mode. Parameter, such as STP, changes the contents of Srch/CloCall option.

Note:

Even when only [FRQ] parameter is set, this command will work.

<COMMAND QSC>

Set current frequency and get reception status

Controller → Radio

QSC, [FRQ], [RSV], [MOD], [ATT], [DLY], [RSV], [CODE_SRCH], [BSC], [REP], [RSV],
[RSV], [RSV], [RSV] [\r]

Radio → Controller

QSC, [RSSI], [FRQ], [SQL] [\r] or QSC, NG [\r]

[FRQ]	:	Frequency (The right frequency)	
[MOD]	:	Modulation (AUTO/AM/FM/NFM/WFM/FMB)	
[ATT]	:	Attenuation (0:OFF / 1:ON)	
[DLY]	:	Delay Time (-10,-5,-2,0,1,2,5,10,30)	
[CODE_SRCH]	:	CTCSS/DCS Search (0:OFF / 1: CTCSS/DCS Search)	
[BSC]	:	Broadcast Screen (16digit: #####.#)	
	(each # is 0 or 1)		·+ Band10
	0 means OFF		:
	1 means ON		+----- Band 2
			+----- Band 1
			+----- Reserve
			+----- NOAA WX
			+----- VHF TV
			+----- UHF TV
			+----- FM
			+----- Pager
[REP]	:	Repeater Find	(0:OFF / 1:ON)
[RSSI]	:	RSSI A/D Value	(0-1023)
[SQL]	:	Squelch Status	(0:CLOSE / 1:OPEN)
[RSV]	:	Reserve Parameter	* This is always only ",".

This command is invalid when the scanner is in Menu Mode, during Direct Entry operation, during Quick Save operation.

FUNCTION

UASD specifies arbitrary frequency and changes to Quick Search Hold (VFO) mode. Parameter, such as STP, changes the contents of Srch/CloCall option.

<COMMAND CSC>

Go to Custom search and get reception status

Controller → Radio

- ① CSC,ON[\r]
- ② CSC,OFF[\r]

Radio → Controller

- ① CSC,[RSSI],[FRQ],[SQL][\r]

CSC,[RSSI],[FRQ],[SQL][\r]

CSC,[RSSI],[FRQ],[SQL][\r]

....

....

....

CSC,[RSSI],[FRQ],[SQL][\r]

- ② CSC,OK[\r]
[RSSI] : RSSI A/D Value (0-1023)
[FRQ] : Current Frequency
[SQL] : Squelch Status (0:CLOSE / 1:OPEN)

This command outputs custom search status of each frequency sequentially.
Use CSC,OFF command to stop the output.

This command is invalid when the scanner is in Menu Mode, during Direct Entry operation, during Quick Save operation.

<COMMAND PWR>

*Get RSSI Level

Controller → Radio

PWR[\r]

Radio → Controller

PWR,[RSSI],[FRQ][\r]

[RSSI] : RSSI A/D Value (0-1023)
[FRQ] : Current Frequency

Returns current RSSI level and its frequency.
The order of the frequency digits is from 1 GHz digit to 100 Hz digit.

<COMMAND STS>

Get Current Status

Controller → Radio

STS[\r]

Radio → Controller

STS, [DSP_FORM], [L1_CHAR], [L1_MODE], [L2_CHAR], [L2_MODE], [L3_CHAR], [L3_MODE], [L4_CHAR], [L4_MODE], ..., [L8_CHAR], [L8_MODE], [SQL], [MUT], [BAT], [WAT], [RSV], [RSV], [SIG_LVL], [RSV], [BK_DIMMER] [\r]

- [DSP_FORM] : Display Form (4 - 8digit:#####)
(each # is 0 or 1) 0 means Small Font / 1 means Large Font.
- [L1_CHAR] : Line1 Characters 16char (fixed length)
- [L1_MODE] : Line1 Display Mode 16char
- [L2_CHAR] : Line2 Characters 16char (fixed length)
- [L2_MODE] : Line2 Display Mode 16char
- [L3_CHAR] : Line3 Characters 16char (fixed length)
- [L3_MODE] : Line3 Display Mode 16char
- [L4_CHAR] : Line4 Characters 16char (fixed length)
- [L4_MODE] : Line4 Display Mode 16char
- :
- [L8_CHAR] : Line8 Characters 16char (fixed length)
- [L8_MODE] : Line8 Display Mode 16char
- [SQL] : Squelch Status (0:CLOSE / 1:OPEN)
- [MUT] : Mute Status (0:OFF / 1:ON)
- [RSV] : Reserve Parameter * This is always only "0".
- [BAT] : Battery Low Status (0:No Alert / 1:Alert)
- [WAT] : Weather Alert Status (0:No Alert / 1: Alert / \$\$\$: Alert
SAME CODE)
- [SIG_LVL] : Signal Level (0 - 5)
- [RSV] : Reserve parameter, always ","
- [BK_DIMMER] : Backlight Dimmer (0:OFF / 1:Low / 2:Middle / 3:High)

NOTE :) Display Mode for Line1 - Line8
 (space) : NORMAL CHAR, *: REVERSE CHAR
 _ (Under bar) : Underline
 If all 16chars are normal, only "," is sent.

The number of [Lx_CHAR] and [Lx_MODE] depend on Display Form.

Ex.1)

```

┌-----┐
│ -- M E N U -- │   Squelch Status      : OPEN
│ Program System │   Mute Status          : OFF
│ Program Location│   Battery Low Status  : No Alert
│ Srch/CloCall Opt│   Weather Alert Status : No Alert
└-----┘
→ STS[\r]
← 1111,
   -- M E N U -- , ← [L1_CHAR]
   _____ , ← [L1_MODE]
```



```

Program System , ← [L2_CHAR]
***** , ← [L2_MODE]
Program Location, ← [L3_CHAR]
, ← [L3_MODE]
Srch/CloCall Opt, ← [L4_CHAR]
, ← [L4_MODE]
1,0,0,0,,,0,,,[\r]

```

Returns current scanner status.

Ex.2)

```

┌-----┐
| HOLD L/O |
| System 1 | Squelch Status : CLOSE
| 851.0125MHz | Mute Status : ON
| P NFM ATT | Battery Low Status : No Alert
| S1: 5 | Weather Alert Status : Alert
| GRP 2 WX |
└-----┘

```

```

→ STS[\r]
← 011000,
    HOLD L/O , ← [L1_CHAR]
    , ← [L1_MODE]
    SYSTEM 1 , ← [L2_CHAR]
    , ← [L2_MODE]
    851.0125MHz , ← [L3_CHAR]
    , ← [L3_MODE]
    P NFM ATT , ← [L4_CHAR]
    , ← [L4_MODE]
    S1: 5 , ← [L5_CHAR]
    , ← [L5_MODE]
    GRP 2 WX, ← [L6_CHAR]
    , ← [L6_MODE]
0,1,0,0,,,1,,,[\r]

```

Returns current scanner status.

<COMMAND GLG>

Get Reception Status

Controller → Radio

GLG[\r]

Radio → Controller

GLG, [FRQ/TGID], [MOD], [ATT], [CTCSS/DCS], [NAME1], [NAME2], [NAME3], [SQL], [MUT],

[SYS_TAG], [CHAN_TAG], [RSV] [\r]

GLG,,,,,,,,, [\r]

- [FRQ/TGID] : Frequency or TGID
- [MOD] : Modulation (AM/FM/NFM/WFM/FMB)
- [ATT] : Attenuation (0:OFF / 1:ON)
- [CTCSS/DCS] : CTCSS/DCS Status (0-231)
*See CTCSS/DCS CODE LIST about the details of this code.
- [NAME1] : System, Site or Search Name
- [NAME2] : Group Name
- [NAME3] : Channel Name
- [SQL] : Squelch Status (0:CLOSE / 1:OPEN)
- [MUT] : Mute Status (0:OFF / 1:ON)
- [SYS_TAG] : Current system number tag (0-999/NONE)
- [CHAN_TAG] : Current channel number tag (0-999/NONE)
- [RSV] : Reserve parameter, always "",

Get reception status.

The Scanner returns GLG,,,,,,,,, [\r] until it detects a frequency or a TGID.

<COMMAND JPM>

Jump Mode

Controller → Radio

JPM, [JUMP_MODE], [INDEX] [\r]

Radio → Controller

JPM,OK[\r]

- [JUMP_MODE] : SCN_MODE Scan mode
- SVC_MODE Service Search mode
- CTM_MODE Custom Search mode
- CC_MODE Close Call Only mode
- WX_MODE WX SCAN mode
- FTO_MODE Tone-Out mode
- [INDEX] : SCN_MODE Channel Index
- SVC_MODE PublicSafety
- News
- HAM
- Marine
- Railroad
- Air
- CB
- FRS/GMRS/MURS
- Racing
- FM
- Special

CTM_MODE	RESERVE
CC_MODE	RESERVE
WX_MODE	NORMAL
	A_ONLY
	SAME_1
	SAME_2
	SAME_3
	SAME_4
	SAME_5
	ALL_FIPS
FTO_MODE	RESERVE

Note) Scanner returns NG in the state that the mode switch cannot be done.

<COMMAND MNU>

Menu Mode
 Controller → Radio
 MNU, [MENU_INDEX] [\r]
 Radio → Controller
 MNU, OK [\r]

[MENU_INDEX]	:	SVC_MENU	:	Service Search Select Menu
WX_MENU	:		:	WX Select Menu
CCBAND_MENU	:		:	Close Call Band Filter Menu
SCR_OPT_MENU	:		:	Broadcast Screen Band Menu
GL_LIST_MENU	:		:	Search Global Lockout List Review Menu
SETTING_MENU	:		:	Setting Menu

Note) Scanner returns NG in the state that the mode switch cannot be done.

<COMMAND JNT>

Jump to Number Tag
 Controller → Radio
 JNT, [SYS_TAG], [CHAN_TAG] [\r]
 Radio → Controller
 JNT, OK [\r]

[SYS_TAG]	:	System Number Tag	(0-999/NONE)
[CHAN_TAG]	:	Channel Number Tag	(0-999/NONE)

When both [SYS_TAG] and [CHAN_TAG] are set as blank, scanner returns error.
 When [SYS_TAG] is set as blank, [CHAN_TAG] is set with a number tag, scanner jump to the channel number tag in current system.
 When [SYS_TAG] is set with a number tag, [CHAN_TAG] is set as blank, scanner jump to the first channel of the system number tag.

```
<COMMAND MDL>
  Get Model Info
  Controller → Radio
MDL[\r]
  Radio → Controller
MDL,BC346XT[\r]
```

Returns Model Information.

```
<COMMAND VER>
  Get Firmware Version
  Controller → Radio
VER[\r]
  Radio → Controller
VER,Version 1.00.00[\r]
```

Returns Firmware Version.

```
<COMMAND PRG>
  Enter Program Mode
  Controller → Radio
PRG[\r]
  Radio → Controller
PRG,OK[\r]
PRG,NG[\r]
```

This command is invalid when the scanner is in Menu Mode, during Direct Entry operation, during Quick Save operation.

The scanner goes to Program Mode.

The scanner displays "Remote Mode" on first line and "Keypad Lock" on second line in Program Mode.

```
<COMMAND EPG>
  Exit Program Mode
  Controller → Radio
EPG[\r]
  Radio → Controller
EPG,OK[\r]
```

The scanner exits from Program Mode.

Then the scanner goes to Scan Hold Mode.

<COMMAND BLT>

Get/Set Backlight
Controller → Radio
BLT[\r]
BLT, [EVNT], [RSV], [DIMMER] [\r]
Radio → Controller
BLT, [EVNT], [RSV], [DIMMER] [\r]
BLT,OK[\r]

[EVENT]

IF : INFINITE
10 : 10sec
30 : 30sec
KY : KEYPRESS
SQ : SQUELCH

[RSV] : Reserve parameter, always “,”
[DIMMER] : Backlight Dimmer (1:Low / 2:Middle / 3:High)

Get/Set Backlight Setting.

This command is only acceptable in Programming Mode.

<COMMAND BSV >

Get/Set Battery Info
Controller → Radio
BSV [\r]
BSV, [BAT_SAVE], [CHARGE_TIME] [\r]

Radio → Controller
BSV, [BAT_SAVE], [CHARGE_TIME] [\r]
BSV,OK[\r]

[BAT_SAVE] Battery Save (0:OFF / 1:ON)
[CHARGE_TIME] Battery Charge Time (1-16)

< COMMAND COM >
Get/Set COM port setting
Controller → Radio
COM, [/r]
COM, [BAUDRATE], [RSV] [/r]

Radio → Controller
COM, [BAUDRATE], [RSV] [/r]
COM, OK [/r]

[BAUDRATE]	:	
	OFF	:OFF
	4800	:4800bps
	9600	:9600bps
	19200	:19200bps
	38400	:38400bps
	57600	:57600bps
	115200	:115200b

Note:

When receive "COM,OK", next command should not be send in 2 second.
Only PC Control (Baud Rate) does not become an initial-setting value.

<COMMAND CLR>
Clear All Memory
Controller → Radio
CLR[\r]
Radio → Controller
CLR, OK [\r]

All the memories are set for initial setting.
This command is only acceptable in Programming Mode.

Note :

It takes dozens of seconds.

Only PC Control (Baud Rate) does not become an initial-setting value.

Memory index pointers are reset to "0". Some data may still exist in deleted memory area.

<COMMAND KBP>

Get/Set Key Beep and setting

Controller → Radio

KBP[\r]

KBP,[LEVEL],[LOCK],[SAFE][\r]

Radio → Controller

KBP,[LEVEL],[LOCK],[SAFE][\r]

KBP,OK[\r]

[LEVEL] : Beep Level (0:Auto / 1-15 / 99:OFF)
[LOCK] : Key Lock status (0:OFF / 1:ON)
[SAFE] : Key Safe status (0:OFF / 1:ON)

Get/Set Key Beep Setting.

This command is only acceptable in Programming Mode.

<COMMAND OMS>

Get/Set Opening Message

Controller → Radio

OMS[\r]

OMS,[L1_CHAR],[L2_CHAR],[L3_CHAR],[L4_CHAR][\r]

Radio → Controller

OMS,[L1_CHAR],[L2_CHAR],[L3_CHAR],[L4_CHAR][\r]

OMS,OK[\r]

[L1_CHAR] : Line1 Characters (max.16char)
[L2_CHAR] : Line2 Characters (max.16char)
[L3_CHAR] : Line3 Characters (max.16char)
[L4_CHAR] : Line4 Characters (max.16char)

If only space code is set in character area, the message returns default message.

This command is only acceptable in Programming Mode.

<COMMAND PRI>

Get/Set Priority Mode

Controller → Radio

PRI[\r] : Get Priority Mode Setting

PRI,[PRI_MODE],[MAX_CHAN],[INTERVAL][\r]

Radio → Controller

PRI,[PRI_MODE],[MAX_CHAN],[INTERVAL][\r]

PRI,OK[\r]

[PRI_MODE] : Priority Setting (0:OFF / 1:ON / 2:PLUS ON)
[MAX_CHAN] : Priority Scan max channels at once (1-100)
[INTERVAL] : Priority Scan Interval time (1-10)

Get/Set Priority Mode.

This command is only acceptable in Programming Mode.

```

<COMMAND SCT>
Get System Count
Controller → Radio
SCT[\r]
Radio → Controller
SCT,###[\r]      : ### (0 - 500)

```

Returns the number of stored System.
This command is only acceptable in Programming Mode.

```

<COMMAND SIH>
Get System Index Head
Controller → Radio
SIH[\r]
Radio → Controller
SIH,[SYS_INDEX][\r]

```

Returns the first index of stored system list.
This command is only acceptable in Programming Mode.

```

<COMMAND SIT>
Get System Index Tail
Controller → Radio
SIT[\r]
Radio → Controller
SIT,[SYS_INDEX][\r]

```

Returns the last index of stored system list.
This command is only acceptable in Programming Mode.

```

<COMMAND QSL>
Get/Set System/Site Quick Lockout
Controller → Radio
QSL[\r]
QSL,[PAGE0],[PAGE1],[PAGE2],[PAGE3],[PAGE4],[PAGE5],[PAGE6],[PAGE7],[PAGE8],
[PAGE9][\r]
Radio → Controller
QSL,[PAGE0],[PAGE1],[PAGE2],[PAGE3],[PAGE4],[PAGE5],[PAGE6],[PAGE7],[PAGE8],
[PAGE9][\r]
QSL,OK[\r]

```

```

[PAGE0] - [PAGE9] : ##### (each # is 0 - 2)
    0 : Not assigned (Displayed as "-" on the scanner.)
    1 : On           (Displayed as each number on the scanner.)
    2 : Off          (Displayed as "*" on the scanner.)
                The Order of Quick Key is as same as LCD Icon.
[PAGE0]          : Quick Key 1 - 9, 0
[PAGE1]          : Quick Key11 - 19,10
[PAGE2]          : Quick Key21 - 29,20
[PAGE3]          : Quick Key31 - 39,30

```



```

[PAGE4]           : Quick Key41 - 49,40
[PAGE5]           : Quick Key51 - 59,50
[PAGE6]           : Quick Key61 - 69,60
[PAGE7]           : Quick Key71 - 79,70
[PAGE8]           : Quick Key81 - 89,80
[PAGE9]           : Quick Key91 - 99,90

```

This command is only acceptable in Programming Mode.
It cannot turn on/off the Quick Key that has no System / Site.

```

<COMMAND QGL>
Get/Set Group Quick Lockout
Controller → Radio
QGL,[SYS_INDEX][\r]
QGL,[SYS_INDEX],#####[\r]
Radio → Controller
QGL,#####[\r]
QGL,OK[\r]

```

```

##### (each # is 0 - 2)      : Group Quick Key status of [SYS_INDEX].
      0 : Not assigned (Displayed as "-" on the scanner.)
      1 : On           (Displayed as each number on the scanner.)
      2 : Off          (Displayed as "*" on the scanner.)

```

The Order of Quick Key is as same as LCD Icon (1 - 9, 0).
This command is only acceptable in Programming Mode.
It cannot turn on/off the Quick Key that has no Group.

```

<COMMAND CSY>
Create System
Controller → Radio
CSY,[SYS_TYPE],[PROTECT][\r]
Radio → Controller
CSY,[SYS_INDEX][\r]

```

```

[SYS_TYPE] : System Type
      CNV      : CONVENTIONAL
      MOT      : MOTOROLA TYPE
      EDC      : EDACS Narrow / Wide
      EDS      : EDACS SCAT
      LTR      : LTR

```

```

[SYS_INDEX] : The Index of Created System
[PROTECT]   : Protect bit Status          (0:OFF / 1:ON)

```

Creates a system and return created system index.
The index is a handle to get/set system information.
Returns -1 if the scanner failed to create because of no resource.
This command is only acceptable in Programming Mode.

```

<COMMAND DSY>
Delete System
Controller → Radio
DSY,[SYS_INDEX][\r]
Radio → Controller
DSY,OK[\r]

```

[SYS_INDEX] : System Index

This command deletes a System.
This command is only acceptable in Programming Mode.

```

<COMMAND SIN>
Get/Set System Info

```

```

Controller → Radio
SIN,[INDEX][\r]
SIN,[INDEX],[NAME],[QUICK_KEY],[HLD],[LOUT],[DLY],[RSV],[RSV],[RSV],[RSV],
[RSV],[START_KEY],[RSV],[RSV],[RSV],[RSV],[RSV],[RSV],[RSV],[NUMBER_TAG],
[RSV],[RSV],[RSV][\r]
Radio → Controller
SIN,[SYS_TYPE],[NAME],[QUICK_KEY],[HLD],[LOUT],[DLY],[RSV],[RSV],[RSV],[RSV],
[RSV],[REV_INDEX],[FWD_INDEX],[CHN_GRP_HEAD],[CHN_GRP_TAIL],[SEQ_NO],
[START_KEY],[RSV],[RSV],[RSV],[RSV],[RSV],[NUMBER_TAG],[RSV],
[RSV],[RSV],[PROTECT],[RSV][\r]
SIN,OK[\r]

```

```

[INDEX]           : System Index
[SYS_TYPE]        : System Type
    CNV           : CONVENTIONAL
    MOT           : MOTOROLA TYPE
    EDC           : EDACS Narrow / Wide
    EDS           : EDACS SCAT
    LTR           : LTR
[NAME]            : Name                (max.16char)
[QUICK_KEY]       : Quick Key           (0-99/(dot) means none)
[HLD]             : System Hold Time    (0-255)
[LOUT]           : Lockout              (0:Unlocked / 1:Lockout)
[DLY]            : Delay Time           (-10,-5,-2,0,1,2,5,10,30)
[REV_INDEX]       : Reverse System Index of the Scan Setting
[FWD_INDEX]       : Forward System Index of the Scan Setting
[CHN_GRP_HEAD]    : Channel Group Index Head of the conventional system or
Site Index Head of the Trunked System
[CHN_GRP_TAIL]    : Channel Group Index Tail of the conventional system or
Site Index Tail of the Trunked System
[SEQ_NO]          : System Sequence Number    (1 - 500)
[START_KEY]       : Startup Configuration Key (0-9/(dot) means none)
[NUMBER_TAG]      : Number tag             (0-999 / NONE)
[PROTECT]         : Protect bit Status     (0:OFF / 1:ON)
[RSV]             : Reserve Parameter      * This is always only ",".

```

Get/Set System Information.

The scanner returns only "," to punctuate for parameters which are not appropriate the system type.

In set command, the scanner neglects the parameters that are not appropriate the system type.

In set command, only "," parameters are not changed.

The set command is aborted if any format error is detected.

This command is only acceptable in Programming Mode.

When the system protect bit is ON, except [SYS_TYPE], [NAME], [REV_INDEX], [FWD_INDEX], [CHN_GRP_HEAD], [CHN_GRP_TAIL], other parameters will be send as a reserve parameter in the Radio -> Controller command.

```
<COMMAND TRN>
Get/Set Trunk Info
Controller → Radio
TRN,[INDEX][\r]
TRN,[INDEX],[ID_SEARCH],[S_BIT],[END_CODE],[AFS],[RSV],[RSV],[EMG],[EMGL],
[FMAP],[CTM_FMAP],[RSV],[RSV],[RSV],[RSV],[RSV],[RSV],[RSV],[RSV],[RSV],
[RSV],[MOT_ID],[RSV],[EMG_PATTERN],[RSV],[PRI_ID_SCAN][\r]
Radio → Controller
TRN,[ID_SEARCH],[S_BIT],[END_CODE],[AFS],[RSV],[RSV],[EMG],[EMGL],[FMAP],
[CTM_FMAP],[RSV],[RSV],[RSV],[RSV],[RSV],[RSV],[RSV],[RSV],[RSV],[RSV],
[TGID_GRP_HEAD],[TGID_GRP_TAIL],[ID_LOUT_GRP_HEAD],[ID_LOUT_GRP_TAIL],
[MOT_ID],[RSV],[EMG_PATTERN],[RSV],[PRI_ID_SCAN][\r]
TRN,OK[\r]

[INDEX]      : System Index
[ID_SEARCH]  : ID Search/Scan (0:ID Scan mode / 1: Search Mode)
[S_BIT]      : Motorola Status Bit (0:Ignore, 1:Yes)
[END_CODE]   : Motorola End Code(0:Ignore,1:Yes)
[AFS]        : EDACS ID Format (0:Decimal / 1:AFS)
[EMG]        : Emergency Alert (0:Ignore / 1-9:Alert)
[EMGL]       : Emergency Alert Level (0:OFF / 1 - 15)
[FMAP]       : Fleet Map (0-16, 0-15:Preset, 16:Custom)
[CTM_FMAP]   : Custom Fleet Map Setting (##### : # is 0-E)
                # means Size Code of each BLOCK (from 0 to 7)
                0 : Size Code 0   5 : Size Code 5   A : Size Code 10
                1 : Size Code 1   6 : Size Code 6   B : Size Code 11
                2 : Size Code 2   7 : Size Code 7   C : Size Code 12
                3 : Size Code 3   8 : Size Code 8   D : Size Code 13
                4 : Size Code 4   9 : Size Code 9   E : Size Code 14
[TGID_GRP_HEAD] : TGID Index Head of the System
[TGID_GRP_TAIL] : TGID Index Tail of the System
[ID_LOUT_GRP_HEAD]: L/O TGID Group Index Head of the System
[ID_LOUT_GRP_TAIL]: L/O TGID Group Index Tail of the System
[MOT_ID]       : Motorola ID Format (0:Decimal / 1:HEX )
[EMG_PATTERN]  : Emergency Alert Light Pattern(0:ON/1:Slow /2:Fast)
[PRI_ID_SCAN]  : Priority ID Scan ( 0:OFF / 1: ON)
[RSV]         : Reserve Parameter * This is always only ",",.
```

Get/Sets Trunked System Information.

The scanner returns only "," to punctuate for parameters which are not appropriate the system type.
 In set command, the scanner neglects the parameters that are not appropriate the system.
 In set command, only "," parameters are not changed.
 The set command is aborted if any format error is detected.
 When the system protect bit is ON, except [TGID_GRP_HEAD], [TGID_GRP_TAIL], [ID_LOUT_GRP_HEAD], [ID_LOUT_GRP_TAIL], other parameters will be send as a reserve parameter in the Radio -> Controller command.
 This command is only acceptable in Programming Mode.

```
<COMMAND AST>
Append Site
Controller → Radio
AST,[SYS_INDEX],[RSV][\r]
Radio → Controller
AST,[SITE_INDEX][\r]
```

```
[SYS_INDEX]           : System Index
[SITE_INDEX]          : Appended Site Index
```

Append Site to the system.
 Returns "-1" if the scanner failed to create because of no resource.
 This command is only acceptable in Programming Mode.

```
<COMMAND SIF>
Get/Set Site Info
Controller → Radio
SIF,[INDEX][\r]
SIF,[INDEX],[NAME],[QUICK_KEY],[HLD],[LOUT],[MOD],[ATT],[RSV],[RSV],[RSV],
[START_KEY],[LATITUDE],[LONGITUDE],[RANGE],[GPS_ENABLE],[RSV],[MOT_TYPE],
[EDACS_TYPE],[RSV],[RSV][\r]
Radio → Controller
SIF,[RSV],[NAME],[QUICK_KEY],[HLD],[LOUT],[MOD],[ATT],[C-CH],[RSV],[RSV],
[REV_INDEX],[FWD_INDEX],[SYS_INDEX],[CHN_HEAD],[CHN_TAIL],[SEQ_NO],
[START_KEY],[LATITUDE],[LONGITUDE],[RANGE],[GPS_ENABLE],[RSV],[MOT_TYPE],
[EDACS_TYPE],[RSV],[RSV][\r]
SIF,OK[\r]
```

```
[INDEX]           : Site Index
[NAME]            : Name (max.16char)
[QUICK_KEY]       : Quick Key (0-99/(dot) means none)
[HLD]             : Site Hold Time (0-255)
[LOUT]           : Lockout (0:Unlocked / 1:Lockout)
[MOD]            : Modulation (AUTO/FM/NFM)
[ATT]            : Attenuation (0:OFF/1:ON)
[C-CH]           : This parameter is always "1"
[REV_INDEX]       : Reverse Site Index of the Scan Setting
[FWD_INDEX]       : Forward Site Index of the Scan Setting
```

```

[SYS_INDEX]      : System Index
[CHN_HEAD]      : Channel Index Head of the Group List
[CHN_TAIL]      : Channel Index Tail of the Group List
[SEQ_NO]        : Site Sequence Number (1-256)
[START_KEY]     : Startup Configuration (0-9/.(dot) means none)
[LATITUDE]      : North or South Latitude
[LONGITUDE]     : West or East Longitude
[RANGE]         : Range (1-250 : 1= 0.5 mile or km)
[GPS_ENABLE]    : GPS Location detection (0:OFF/1:ON)
[MOT_TYPE]      : Band type for MOT/EDACS(STD/ SPL/CUSTOM)
[EDACS_TYPE]    : EDACS (WIDE/NARROW)
[RSV]           : Reserve Parameter * This is always only ",".

```

Get/Set Site Information.

The scanner returns only ",," to punctuate for parameters which are not appropriate the site type.

In set command, the scanner neglects the parameters that are not appropriate the system type.

In set command, only ",," parameters are not changed.

The set command is aborted if any format error is detected.

When the system protect bit is ON, except [REV_INDEX], [FWD_INDEX], [SYS_INDEX], [CHN_HEAD], [CHN_TAIL], other parameters will be send as a reserve parameter in the Radio -> Controller command.

This command is only acceptable in Programming Mode.

<COMMAND MCP>

Get/Set Motorola Custom Band Plan

Controller → Radio

MCP, [INDEX] [\r]

MCP, [INDEX], [LOWER1], [UPPER1], [STEP1], [OFFSET1], [LOWER2], [UPPER2], [STEP2], [OFFSET2], [LOWER3], [UPPER3], [STEP3], [OFFSET3], [LOWER4], [UPPER4], [STEP4], [OFFSET4], [LOWER5], [UPPER5], [STEP5], [OFFSET5], [LOWER6], [UPPER6], [STEP6], [OFFSET6] [\r],

Radio → Controller

MCP, [LOWER1], [UPPER1], [STEP1], [OFFSET1], [LOWER2], [UPPER2], [STEP2], [OFFSET2], [LOWER3], [UPPER3], [STEP3], [OFFSET3], [LOWER4], [UPPER4], [STEP4], [OFFSET4], [LOWER5], [UPPER5], [STEP5], [OFFSET5], [LOWER6], [UPPER6], [STEP6], [OFFSET6] [\r],

MCP, OK [\r]

```

[INDEX]      : Site Index
[LOWER n]    : Lower Frequency n
[UPPER n]    : Upper Frequency n
[STEP n]     : Step n
              "500": 5.0k      "625": 6.25k    "1000": 10.0k
              "1250": 12.5k    "1500": 15.0k   "1875": 18.75k
              "2000": 20.0k    "2500": 25.0k   "3000": 30.0k
              "3125": 31.25k   "3500": 35.0k   "3750": 37.5k
              "4000": 40.0k    "4375": 43.75k  "4500": 45.0k
              "5000": 50.0k    "5500": 55.0k   "5625": 56.25k
              "6000": 60.0k    "6250": 62.5k   "6500": 65.0k

```

"6875": 68.75k	"7000": 70.0k	"7500": 75.0k
"8000": 80.0k	"8125": 81.25k	"8500": 85.0k
"8750": 87.5k	"9000": 90.0k	"9375": 93.75k
"9500": 95.0k	"10000": 100.0k	

[OFFSETn] : Offset n (-1023 to 1023)

Get/Sets Band Plan Setting for MOT 800 custom/VHF/UHF site.

In set command, if only "," parameters are send the Band Plan setting of the site will not changed.

The set command is aborted if any format error is detected.

When the system protect bit is ON, all the parameters will be send as a reserve parameter in the Radio -> Controller command.

Before using this command, user should set Band Plan type as "Custom" first by using SIF command.

This command is only acceptable in Programming Mode.

<COMMAND TFQ>

Get/Set Trunk Frequency Info

Controller → Radio

TFQ, [CHN_INDEX] [\r]

TFQ, [CHN_INDEX], [FRQ], [LCN], [LOUT], [RSV], [NUMBER_TAG], [VOL_OFFSET], [RSV] [\r]

Radio → Controller

TFQ, [FRQ], [LCN], [LOUT], [REV_INDEX], [FWD_INDEX], [SYS_INDEX], [GRP_INDEX], [RSV], [NUMBER_TAG], [VOL_OFFSET], [RSV] [\r]

TFQ,OK[\r]

[CHN_INDEX]	:	Trunk Frequency Index
[FRQ]	:	Trunk Frequency
[LCN]	:	LCN
		(EDACS WIDE/NARROW system: 0 to 20
		LTR system: 0 to 30)
[LOUT]	:	Lockout (0:Unlocked / 1:Lockout)
[REV_INDEX]	:	Reverse Frequency Index of the Site
[FWD_INDEX]	:	Forward Frequency Index of the Site
[SYS_INDEX]	:	System Index of the Frequency
[GRP_INDEX]	:	Index of the Site
[NUMBER_TAG]	:	Number tag (0-999 / NONE)
[VOL_OFFSET]	:	Volume Offset (-3 - +3)

In set command, only "," parameters are not changed.

The set command is aborted if any format error is detected.

This command is only acceptable in Programming Mode.

For Motorola or EDACS SCAT System, [LCN] is ignored.

When the system protect bit is ON, except [REV_INDEX], [FWD_INDEX], [SYS_INDEX], [GRP_INDEX], other parameters will be send as a reserve parameter in the Radio -> Controller command.

[NUMBER_TAG] and [VOL_OFFSET] are just used for SCAT system.

```
<COMMAND AGC>
Append Channel Group
Controller → Radio
AGC, [SYS_INDEX] [\r]
Radio → Controller
AGC, [GRP_INDEX] [\r]
```

```
[SYS_INDEX] : System Index
[GRP_INDEX] : appended Channel Group Index
```

Append Channel Group to the system.
Returns "-1" if the scanner failed to create because of no resource.
This command is only acceptable in Programming Mode.

```
<COMMAND AGT>
Append TGID Group
Controller → Radio
AGT, [SYS_INDEX] [\r]
Radio → Controller
AGT, [GRP_INDEX] [\r]
```

```
[SYS_INDEX] : System Index
[GRP_INDEX] : appended TGID Group Index
```

Append TGID Group to the system.
Returns "-1" if the scanner failed to create because of no resource.
This command is only acceptable in Programming Mode.

```
<COMMAND DGR>
Delete Group / Site
Controller → Radio
DGR, [INDEX] [\r]
Radio → Controller
DGR, OK [\r]
```

```
[INDEX] : Group / Site Index
```

This command deletes a Channel Group, TGID Group or Site.
This command is only acceptable in Programming Mode.

```

<COMMAND GIN>
Get/Set Group Info
Controller → Radio
GIN, [GRP_INDEX] [\r]
GIN, [GRP_INDEX], [NAME], [QUICK_KEY], [LOUT], [LATITUDE], [LONGITUDE], [RANGE],
[GPS ENABLE] [\r]
Radio → Controller
GIN, [GRP_TYPE], [NAME], [QUICK_KEY], [LOUT], [REV_INDEX], [FWD_INDEX], [SYS_INDEX],
[CHN_HEAD], [CHN_TAIL], [SEQ_NO] , [LATITUDE], [LONGITUDE], [RANGE], [GPS ENABLE] [\r]
GIN, OK [\r]

```

For Group Information

```

[GRP_INDEX]      : Group Index
[GRP_TYPE]       : Group Type          (C: Channel Group / T: TGID Group)
[NAME]           : Name                (max.16char)
[QUICK_KEY]      : Quick Key (1-9,0: means 10, .(dot): means none)
[LOUT]           : Lockout              (0:Unlocked / 1:Lockout)
[REV_INDEX]      : Reverse Group Index of the System
[FWD_INDEX]      : Forward Group Index of the System
[SYS_INDEX]      : System Index
[CHN_HEAD]       : Channel Index Head of the Group List
[CHN_TAIL]       : Channel Index Tail of the Group List
[SEQ_NO]         : Group Sequence Number of the System
[LATITUDE]       : North or South Latitude
[LONGITUDE]      : West or East Longitude
[RANGE]          : Range                (1-250 : 1= 0.5 mile or km)
[GPS ENABLE]     : GPS Location detection (0:OFF/1:ON)

```

Get/Set Group Information.

In set command, only ", " parameters are not changed.

The set command is aborted if any format error is detected.

When the system protect bit is ON, except [NAME], [REV_INDEX], [FWD_INDEX], [SYS_INDEX], [CHN_HEAD], [CHN_TAIL], other parameters will be send as a reserve parameter in the Radio -> Controller command.

This command is only acceptable in Programming Mode.

```
<COMMAND ACC>
Append Channel / Trunk Frequency
Controller → Radio
ACC, [GRP_INDEX] [\r]
Radio → Controller
ACC, [CHN_INDEX] [\r]
```

```
[GRP_INDEX] : Channel Group Index
[CHN_INDEX] : Appended Channel Index
```

- or -

```
[GRP_INDEX] : Site Index
[CHN_INDEX] : Appended Trunk Frequency Index
```

Append Channel to the group. Or, append Trunk Frequency to the Site. Returns "-1" if the scanner failed to create because of no resource. This command is only acceptable in Programming Mode.

```
<COMMAND ACT>
Append TGID
Controller → Radio
ACT, [GRP_INDEX] [\r]
Radio → Controller
ACT, [INDEX] [\r]
```

```
[GRP_INDEX] : TGID Group Index
[TGID_INDEX] : appended TGID Index
```

Append TGID to the group. Returns "-1" if the scanner failed to create because of no resource. This command is only acceptable in Programming Mode.

```
<COMMAND DCH>
Delete Channel
Controller → Radio
DCH, [INDEX] [\r]
Radio → Controller
DCH,OK[\r]
```

```
[INDEX] : Channel Index, TGID Index or Trunked Frequency Index
```

This command deletes a Channel and TGID. This command is also valid for deleting a Trunk Frequency. This command is only acceptable in Programming Mode.

```

<COMMAND CIN>
Get/Set Channel Info
Controller → Radio
CIN, [INDEX] [\r]
CIN, [INDEX], [NAME], [FRQ], [MOD], [CTCSS/DCS], [TLOCK], [LOUT], [PRI], [ATT], [ALT],
[ALTL], [RSV], [RSV], [RSV], [NUMBER_TAG], [RSV], [ALT_PATTERN],
[VOL_OFFSET] [\r]
Radio → Controller
CIN, [NAME], [FRQ], [MOD], [CTCSS/DCS], [TLOCK], [LOUT], [PRI], [ATT], [ALT], [ALTL],
[REV_INDEX], [FWD_INDEX], [SYS_INDEX], [GRP_INDEX], [RSV], [RSV], [RSV],
[NUMBER_TAG], [RSV], [ALT_PATTERN], [VOL_OFFSET] [\r]
CIN,OK[\r]

```

[INDEX]	: Channel Index
[NAME]	: Name (max.16char)
[FRQ]	: Channel Frequency
[MOD]	: Modulation (AUTO/AM/FM/NFM/WFM/FMB)
[ATT]	: Attenuation (0:OFF / 1:ON)
[CTCSS/DCS]	: CTCSS/DCS Status (0-231)
	*See <u>CTCSS/DCS</u> CODE LIST about the details of this code.
[TLOCK]	: CTCSS/DCS Tone Lockout(0:OFF / 1:ON)
[LOUT]	: Lockout (0:Unlocked / 1:Lockout)
[PRI]	: Priority (0:OFF / 1:ON)
[ALT]	: Alert Tone (0:OFF / 1-9:Tone No)
[ALTL]	: Alert Tone Level (0:AUTO/ 1-15)
[REV_INDEX]	: Reverse Channel Index of the Chan0nel Group
[FWD_INDEX]	: Forward Channel Index of the Channel Group
[SYS_INDEX]	: System Index of the Channel
[GRP_INDEX]	: Group Index of the Channel
[NUMBER_TAG]	: Number tag (0-999 / NONE)
[ALT_PATTERN]	: Alert Light Pattern(0:ON / 1:SLow / 2:Fast)
[VOL_OFFSET]	: Volume Offset (-3 - +3)

Get/Set Channel Information.

In set command, only ", " parameters are not changed.

The set command is aborted if any format error is detected.

This command is only acceptable in Programming Mode.

When the system protect bit is ON, except [REV_INDEX], [FWD_INDEX], [SYS_INDEX], [GRP_INDEX], other parameters will be send as a reserve parameter in the Radio -> Controller command.

```

<COMMAND TIN>
Get/Set TGID Info
Controller → Radio
TIN,[INDEX][\r]
TIN,[INDEX],[NAME],[TGID],[LOUT],[PRI],[ALT],[ALTL],[RSV],[RSV],
[NUMBER_TAG],[RSV],[ALT_PATTERN],[VOL_OFFSET][\r]
Radio → Controller
TIN,[NAME],[TGID],[LOUT],[PRI],[ALT],[ALTL],[REV_INDEX],[FWD_INDEX],
[SYS_INDEX],[GRP_INDEX],[RSV],[RSV],[NUMBER_TAG],[RSV],
[ALT_PATTERN],[VOL_OFFSET][\r]
TIN,OK[\r]

```

```

[INDEX]           : TGID Index
[NAME]            : Name (max.16char)
[TGID]            : TGID
[LOUT]            : Lockout                (0:Unlocked / 1:Lockout)
[PRI]             : Priority                (0:OFF / 1:ON)
[ALT]             : Alert Tone             (0:OFF / 1-9:Tone No)
[ALTL]            : Alert Tone Level       (0:AUTO/ 1-15)
[REV_INDEX]       : Reverse TGID Index of the Group
[FWD_INDEX]       : Forward TGID Index of the Group
[SYS_INDEX]       : System Index of the TGID
[GRP_INDEX]       : Group Index of the TGID
[NUMBER_TAG]      : Number tag              (0-999 / NONE)
[ALT_PATTERN]     : Alert Light Pattern(0:ON / 1:SLow / 2:Fast)
[VOL_OFFSET]      : Volume Offset          (-3 - +3)

```

Get/Set TGID Information.

In set command, only "," parameters are not changed.

The set command is aborted if any format error is detected.

This command is only acceptable in Programming Mode.

When the system protect bit is ON, except [REV_INDEX], [FWD_INDEX], [SYS_INDEX], [GRP_INDEX], other parameters will be send as a reserve parameter in the Radio -> Controller command.

```

<COMMAND GLI>
Get Lockout TGID (for Rvw L/O ID)
Controller → Radio
GLI,[SYS_INDEX][\r]
Radio → Controller
GLI,[TGID][\r]
GLI,-1[\r]           : No more lockout TGID

```

This command is used to get L/O TGID list of a system.

You should call this command again and again to get all L/O TGID until the scanner returns "-1".

"-1" means that no more L/O TGID exists.

When the system protect bit is ON, only "-1" will be send in the Radio -> Controller command.

This command is only acceptable in Programming Mode.

```
<COMMAND SLI>
Get Search L/O TGID
Controller → Radio
SLI,[SYS_INDEX][\r]
Radio → Controller
SLI,[TGID][\r]
SLI,-1[\r]           : No more lockout TGID
```

This command is used to get Search L/O TGID list of the system.
Search L/O TGID is the L/O TGID which doesn't belong to any group in the system as a TGID.

Compared with GLI command, this command doesn't return any L/O TGID which is belong to one of group in the system.

You should call this command again and again to get all L/O TGID until the scanner returns "-1".

"-1" means that no more L/O TGID exists.

This command is only acceptable in Programming Mode.

```
<COMMAND ULI>
Unlock TGID (for Rvw L/O ID)
Controller → Radio
ULI,[SYS_INDEX],[TGID][\r]
Radio → Controller
ULI,OK[\r]
```

This command unlocks a L/O TGID in a system.

The TGID is deleted from L/O list.

This command is only acceptable in Programming Mode.

```
<COMMAND LOI>
Lockout ID (TGID)
Controller → Radio
LOI,[SYS_INDEX],[TGID][\r]
Radio → Controller
LOI,OK[\r]
```

This command locks out a TGID for the system.

The TGID is added to L/O list.

This command is only acceptable in Programming Mode.

```
<COMMAND REV>
Get Rev Index
Controller → Radio
REV, [INDEX] [\r]
Radio → Controller
REV, [INDEX] [\r]
```

[INDEX] : Index of system, site, group, channel, TGID or Location Alert System.

Returns reverse(backward) index of the index in the memory chain.

Returns -1 if no more index exists.

This command is only acceptable in Programming Mode.

```
<COMMAND FWD>
Get Fwd Index
Controller → Radio
FWD, [INDEX] [\r]
Radio → Controller
FWD, [INDEX] [\r]
```

[INDEX] : Index of system, site, group, channel, TGID or Location Alert System.

Returns forward index of the index in the memory chain.

Returns -1 if no more index exists.

This command is only acceptable in Programming Mode.

```
<COMMAND RMB>
Get Remains of Memory Block
Controller → Radio
RMB [\r]
Radio → Controller
RMB, ##### [\r]
```

Returns the number of idle(free) memory block.

: ##### (not zero-padding)

This command is only acceptable in Programming Mode.

```

<COMMAND MEM>
Get Memory Used
Controller → Radio
MEM[\r]
Radio → Controller
MEM, [MEMORY_USED], [SYS], [SITE], [CHN], [LOC] [\r]

[MEMORY_USED] : The percent of memory that is used      (0 - 100)
[SYS]          : The number of systems that is created   (0 - 500)
[SITE]         : The number of sites that is created     (0 - 1000)
[CHN]          : The number of channels that is created  (0 - 9000)
[LOC]          : The number of location system that is created (0 - 1000)

```

This command is only acceptable in Programming Mode.

```

<COMMAND LIH>
Get Location Alert System Index Head
Controller → Radio
LIH, [LAS_TYPE] [\r]
Radio → Controller
LIH, [INDEX] [\r]

[LAS_TYPE]      : Location Alert Type
                 (POI:POI / DROAD: Dangerous Road / DXING : Dangerous Xing)

```

Returns the first index of stored location alert system list.
This command is only acceptable in Programming Mode.

```

<COMMAND LIT>
Get Location Alert System Index Tail
Controller → Radio
LIT, [LAS_TYPE] [\r]
Radio → Controller
LIT, [INDEX] [\r]

[LAS_TYPE]      : Location Alert Type
                 (POI:POI / DROAD: Dangerous Road / DXING : Dangerous Xing)

```

Returns the last index of stored location alert system list.
This command is only acceptable in Programming Mode.

```
<COMMAND CLA>
Create Location Alert System
Controller → Radio
CLA, [LAS_TYPE] [\r]
Radio → Controller
CLA, [INDEX] [\r]
```

```
[LAS_TYPE] : Location Alert Type
              (POI: POI / DROAD: Dangerous Road / DXING: Dangerous Xing)
[INDEX] : Location Alert System Index
```

Creates a system and return created location alert system index.
The index is a handle to get/set location alert system information.
Returns "-1" if the scanner failed to create because of no resource.
This command is only acceptable in Programming Mode.

```
<COMMAND DLA>
Delete Location Alert System
Controller → Radio
DLA, [INDEX] [\r]
Radio → Controller
DLA, OK [\r]
```

```
[INDEX] : Location Alert System Index
```

This command deletes a location alert system.
This command is only acceptable in Programming Mode.

```

<COMMAND LIN>
Get/Set Location Alert System Info
Controller → Radio
LIN, [INDEX] [\r]
LIN, [INDEX], [LAS_TYPE], [NAME], [LOUT], [ALT], [ALTL], [LATITUDE], [LONGITUDE],
[RANGE], [SPEED], [DIR], [RSV], [ALT_PATTERN] [\r]
Radio → Controller
LIN, [LAS_TYPE], [NAME], [LOUT], [ALT], [ALTL], [REV_INDEX], [FWD_INDEX], [SEQ_NO],
[LATITUDE], [LONGITUDE], [RANGE], [SPEED], [DIR], [RSV], [ALT_PATTERN] [\r]
LIN, OK [\r]

```

```

[INDEX]           : Location Alert System Index
[LAS_TYPE]        : Location Alert Type
                  (POI: POI / DROAD: Dangerous Road / DXING: Dangerous Xing)
[NAME]            : Name (max.16char)
[LOUT]            : Lockout (0:Unlocked / 1:Lockout)
[ALT]             : Alert Tone (0:OFF/1 - 4:Tone No.)
[ALTL]           : Alert Tone Level (0:AUTO/1-15)
[REV_INDEX]       : Reverse System Index of Location Alert System
[FWD_INDEX]       : Forward System Index of Location Alert System
[SEQ_NO]          : Location Alert System Sequence Number
[LATITUDE]        : North or South Latitude
[LONGITUDE]       : West or East Longitude
[RANGE]           : Range (1-80: 1=0.05 mile or km)
[SPEED]           : Speed Limit (0-200: 1 means 1 mile/hour or km/h)
[DIR]             : Heading (0-358/360 : 2' step, 360=All range)
[ALT_PATTERN]     : Alert Light Pattern(0:ON / 1:SLow / 2:Fast)

```

Get/Set Location Alert System Information.

In set command, the scanner neglects the parameters that are not appropriate the system type.

In set command, only "," parameters are not changed.

The set command is aborted if any format error is detected.

This command is only acceptable in Programming Mode.

```

<COMMAND SCO>
Get/Set Search/Close Call Settings
Controller → Radio
SCO[\r]
SCO, [RSV], [MOD], [ATT], [DLY], [RSV], [CODE_SRCH], [BSC], [REP], [RSV], [RSV],
[ MAX_STORE], [RSV], [RSV], [RSV], [RSV] [\r]
Radio → Controller
SCO, [RSV], [MOD], [ATT], [DLY], [RSV], [CODE_SRCH], [BSC], [REP], [RSV], [RSV],
[ MAX_STORE], [RSV], [RSV], [RSV], [RSV] [\r]
SCO,OK[\r]

```

```

[MOD]      : Modulation          (AUTO/AM/FM/NFM/WFM/FMB)
[ATT]      : Attenuation         (0:OFF / 1:ON)
[DLY]      : Delay Time         (-10,-5,-2,0,1,2,5,10,30)
[CODE_SRCH]: CTCSS/DCS Search
              (0:OFF / 1: CTCSS/DCS Search)
[BSC]      : Broadcast Screen   (16digit: #####*#)
              (each # is 0 or 1)   |||||||*+ Band10
              0 means OFF         |||||||      :
              1 means ON         |||||+----- Band 2
                                   |||||+----- Band 1
                                   |||||+----- Reserve
                                   |||+----- NOAA WX
                                   ||+----- VHF TV
                                   |+----- UHF TV
                                   +----- FM
                                   +----- Pager
[REP]      : Repeater Find      (0:OFF / 1:ON)
[ MAX_STORE]: Max Auto Store    (1-256)

```

Get/Set Search/Close Call Settings.
 In set command, only ", " parameters are not changed.
 The set command is aborted if any format error is detected.
 This command is only acceptable in Programming Mode.

```

<COMMAND BBS>
Get/Set Broadcast Screen Band Settings
Controller → Radio
BBS, [INDEX] [\r]
BBS, [INDEX], [LIMIT_L], [LIMIT_H] [\r]
Radio → Controller
BBS, [LIMIT_L], [LIMIT_H] [\r]
BBS,OK[\r]

```

```

[INDEX]      : Index          (1-9,0 means 10)
[LIMIT_L]    : Lower Limit Frequency (00000000 -99999999)
[LIMIT_H]    : Upper Limit Frequency (00000000 -99999999)

```

Get/Set Broadcast Screen Band Settings. This command is only acceptable in Programming Mode.

```

<COMMAND SHK>
Get/Set Search Key Settings
Controller → Radio
SHK[\r]
SHK,[SRCH_KEY_1],[SRCH_KEY_2],[SRCH_KEY_3],[RSV],[RSV],[RSV][\r]
Radio → Controller
SHK,[SRCH_KEY_1],[SRCH_KEY_2],[SRCH_KEY_3],[RSV],[RSV],[RSV][\r],SHK,OK[\r]

```

```

[SRCH_KEY_1] - [SRCH_KEY_3] : Search Range
.(dot) : Not assign
PublicSafety: Public Safety range CUSTOM_1: Custom 1 range
News : News range CUSTOM_2: Custom 2 range
HAM : HAM Radio range CUSTOM_3: Custom 3 range
Marine : Marine range CUSTOM_4: Custom 4 range
Railroad : Railroad range CUSTOM_5: Custom 5 range
Air : Air range CUSTOM_6: Custom 6 range
CB : CB Radio range CUSTOM_7: Custom 7 range
FRS/GMRS/MURS: FRS/GMRS/MURS range CUSTOM_8: Custom 8 range
Racing : Racing range CUSTOM_9: Custom 9 range
FM : FM Broadcast range CUSTOM_10: Custom 10 range
Special : Special range TONE_OUT: Tone Out mode

```

Get/Set Search Key Settings.
This command is only acceptable in Programming Mode.

```

<COMMAND GLF>
Get Global Lockout Freq
Controller → Radio
GLF[\r]
Radio → Controller
GLF,[FRQ][\r]
GLF,-1[\r]

```

```

[FRQ] : Lockout Frequency (250000-13000000)

```

This command is used to get Global L/O frequency list.
You should call this command again and again to get all-global L/O frequency until the scanner returns "-1".
"-1" means that no more L/O frequency exists.
This command is only acceptable in Programming Mode.

```
<COMMAND ULF>
Unlock Global L/O
Controller → Radio
ULF,[FRQ][\r]
Radio → Controller
ULF,OK[\r]
```

[FRQ] : Lockout Frequency (250000-13000000)

This command unlocks a L/O frequency.
The frequency is deleted from L/O list.
This command is only acceptable in Programming Mode.

```
<COMMAND LOF >
Lock Out Frequency
Controller → Radio
LOF,[FRQ][\r]
Radio → Controller
LOF,OK[\r]
```

[FRQ] : Frequency (250000-13000000)

This command locks out a frequency.
The frequency is added to L/O list.
This command is only acceptable in Programming Mode.

```

<COMMAND CLC>
Get/Set Close Call Settings
Controller → Radio
CLC[\r]
CLC,[CC_MODE],[CC_OVERRIDE],[RSV],[ALTB],[ALTL],[ALTP],[CC_BAND],[LOUT],
[HLD],[QUICK_KEY],[NUMBER_TAG],[RSV],[ALT_PATTERN][\r]
Radio → Controller
CLC,[CC_MODE],[CC_OVERRIDE],[RSV],[ALTB],[ALTL],[ALTP],[CC_BAND],[LOUT],
[HLD],[QUICK_KEY],[NUMBER_TAG],[RSV],[ALT_PATTERN][\r]
CLC,OK[\r]

```

```

[CC_MODE]           : Mode           ( 0:OFF / 1:CC PRI / 2:CC DND)
[CC_OVERRIDE]       : Override         (1:ON / 0:OFF)
[ALTB]              : Alert Beep      (0:OFF / 1-9:Tone No)
[ALTL]              : Alert Tone Level (0:AUTO/ 1-15)
[ALTP]              : Close Call Pause
                    3      : 3 sec           5      : 5 sec
                    10     : 10 sec          15     : 15 sec
                    30     : 30 sec          45     : 45 sec
                    60     : 60 sec          INF    : Infinite
[CC_BAND]           : Close Call Band  (7digit ##### )
                    (each # is 0 or 1)  |||||+- 800MHz+
                    0 means OFF         ||||+--- UHF
                    1 means ON          |||+---- Reserve
                                         ||+----- VHF HIGH
                                         |+----- AIR BAND
                                         |+----- VHF LOW2
                                         +----- VHF LOW1
[LOUT]              : Lockout for CC Hits with Scan(0:Unlocked/1:Lockout)
[HLD]               : System Hold Time for CC Hits with Scan (0-255)
[QUICK_KEY]         : Quick Key for CC Hits with Scan (0 - 99/.(dot) )
                    *".(dot)" means that nothing is assigned.
[NUMBER_TAG]        : Number tag        (0-999 / NONE)
[ALT_PATTERN]       : Alert Light Pattern(0:ON / 1:Slow / 2:Fast)
[RSV]               : Reserve Parameter * This is always only ",".

```

Get/Set Close Call Settings.
 In set command, only ", " parameters are not changed.
 The set command is aborted if any format error is detected.
 This command is only acceptable in Programming Mode.

<COMMAND SSP>

Get/Set Service Search Settings

Controller → Radio

SSP,[SRCH_INDEX][\r]

SSP,[SRCH_INDEX],[DLY],[ATT],[HLD],[LOUT],[QUICK_KEY],[START_KEY],[RSV],[NUMBER_TAG],[RSV],[RSV],[RSV] [\r]

Radio → Controller

SSP,[SRCH_INDEX],[DLY],[ATT],[HLD],[LOUT],[QUICK_KEY],[START_KEY],[RSV],[NUMBER_TAG],[RSV],[RSV],[RSV] [\r]

SSP,OK[\r]

[SRCH_INDEX]	: Service Search Range		
	1 : Public Safety	6 : Air	12 : Special
	2 : News	7 : CB Radio	
	3 : HAM Radio	8 : FRS/GMRS/MURS	
	4 : Marine	9 : Racing	
	5 : Railroad	11 : FM Broadcast	
[DLY]	: Delay Time	(-10,-5,-2,0,1,2,5,10,30)	
[ATT]	: Attenuation	(0:OFF/1:ON)	
[HLD]	: System Hold Time for Search with Scan	(0-255)	
[LOUT]	: Lockout for Search with Scan	(0:Unlocked/1:Lockout)	
[QUICK_KEY]	: Quick Key	(0 - 99 / .(dot))	
[START_KEY]	: Startup Configuration Key	(0 - 9 / .(dot))	
[NUMBER_TAG]	: Number tag	(0-999 / NONE)	

The set command is aborted if any format error is detected.

This command is only acceptable in Programming Mode.

<COMMAND CSG>

Get/Set Custom Search Group

Controller → Radio

CSG[\r]

CSG,#####[\r] : Status of Each Search Range

Radio → Controller

CSG,#####[\r]

CSG,OK[\r]

(each # is 0 or 1) : 0 : valid / 1 : invalid

The Order of Range is as same as LCD Icon (1 - 10).

Get/Set current status of the custom search range.

This command is only acceptable in Programming Mode.

*It can not set all Custom Search Ranges to "0".

<COMMAND CBP>

Get/Set C-Ch Only Custom Search MOT Band Plan Settings

Controller → Radio

CBP, [SRCH_INDEX] [\r]

CBP, [SRCH_INDEX], [MOT_TYPE], [LOWER1], [UPPER1], [STEP1], [OFFSET1], [LOWER2], [UPPER2], [STEP2], [OFFSET2], [LOWER3], [UPPER3], [STEP3], [OFFSET3], [LOWER4], [UPPER4], [STEP4], [OFFSET4], [LOWER5], [UPPER5], [STEP5], [OFFSET5], [LOWER6], [UPPER6], [STEP6], [OFFSET6] [\r],

Radio → Controller

CBP, [MOT_TYPE], [LOWER1], [UPPER1], [STEP1], [OFFSET1], [LOWER2], [UPPER2], [STEP2], [OFFSET2], [LOWER3], [UPPER3], [STEP3], [OFFSET3], [LOWER4], [UPPER4], [STEP4], [OFFSET4], [LOWER5], [UPPER5], [STEP5], [OFFSET5], [LOWER6], [UPPER6], [STEP6], [OFFSET6] [\r],

CBP, OK [\r]

[SRCH_INDEX]	:	Index	(1-9,0 means 10)
[MOT_TYPE]	:	Band type for MOT(STD/ SPL/CUSTOM)	
[LOWER n]	:	Lower Frequency n	
[UPPER n]	:	Upper Frequency n	
[STEP n]	:	Step n	
		"500": 5.0k	"625": 6.25k "1000": 10.0k
		"1250": 12.5k	"1500": 15.0k "1875": 18.75k
		"2000": 20.0k	"2500": 25.0k "3000": 30.0k
		"3125": 31.25k	"3500": 35.0k "3750": 37.5k
		"4000": 40.0k	"4375": 43.75k "4500": 45.0k
		"5000": 50.0k	"5500": 55.0k "5625": 56.25k
		"6000": 60.0k	"6250": 62.5k "6500": 65.0k
		"6875": 68.75k	"7000": 70.0k "7500": 75.0k
		"8000": 80.0k	"8125": 81.25k "8500": 85.0k
		"8750": 87.5k	"9000": 90.0k "9375": 93.75k
		"9500": 95.0k	"10000": 100.0k
[OFFSETn]	:	Offset n (-1023 to 1023)	

Get/Sets Band Plan Setting for MOT 800custom/VHF/UHFsite when trunking control channel in custom search.

In set command, if only "," parameters are send the Band Plan setting will not changed. The set command is aborted if any format error is detected.

If [MOT_TYPE] is not CUSTOM, any other setting will be ignored.

This command is only acceptable in Programming Mode.

<COMMAND CSP>

Get/Set Custom Search Settings

Controller → Radio

CSP, [SRCH_INDEX] [\r]

CSP, [SRCH_INDEX], [NAME], [LIMIT_L], [LIMIT_H], [STP], [MOD], [ATT], [DLY], [RSV], [HLD], [LOUT], [C-CH], [RSV], [RSV], [QUICK_KEY], [START_KEY], [RSV], [NUMBER_TAG], [RSV], [RSV], [RSV] [\r]

Radio → Controller

CSP, [NAME], [LIMIT_L], [LIMIT_H], [STP], [MOD], [ATT], [DLY], [RSV], [HLD], [LOUT], [C-CH], [RSV], [RSV], [QUICK_KEY], [START_KEY], [RSV], [NUMBER_TAG], [RSV], [RSV], [RSV] [\r]

CSP,OK[\r]

[SRCH_INDEX]	: Index	(1-9,0 means 10)
[NAME]	: Name	(max.16char)
[LIMIT_L]	: Lower Limit Frequency	(250000-13000000)
[LIMIT_H]	: Upper Limit Frequency	(250000-13000000)
[STP]	: Search Step	
AUTO : AUTO	833	: 8.33k 2000 : 20k
500 : 5k	1000	: 10k 2500 : 25k
625 : 6.25k	1250	: 12.5k 5000 : 50k
750 : 7.5 k	1500	: 15k 10000 : 100k
[MOD]	: Modulation	(AUTO/AM/FM/NFM/WFM/FMB)
[ATT]	: Attenuation	(0:OFF / 1:ON)
[DLY]	: Delay Time	(-10,-5,-2,0,1,2,5,10,30)
[HLD]	: System Hold Time	(0-255)
[LOUT]	: Lockout	(0:Unlocked / 1:Lockout)
[C-CH]	: Control Channel Only	(0:OFF / 1:ON)
[QUICK_KEY]	: Quick Key	(0 - 99 / .(dot))
[START_KEY]	: Startup Configuration Key	(0 - 9/ .(dot))
[NUMBER_TAG]	: Number tag	(0-999 / NOE)

Get/Set Custom Search Settings.

In set command, only ", " parameters are not changed.

The set command is aborted if any format error is detected.

This command is only acceptable in Programming Mode.

```

<COMMAND WXS>
Get/Set Weather Settings
Controller → Radio
WXS[\r]
WXS,[DLY],[ATT],[ALT_PRI],[RSV],[RSV],[RSV] [\r]
Radio → Controller
WXS,[DLY],[ATT],[ALT_PRI],[RSV],[RSV],[RSV] [\r]
WXS,OK[\r]

[DLY]          : Delay Time                (-10,-5,-2,0,1,2,5,10,30)
[ATT]          : Attenuation                (0:OFF / 1:ON)
[ALT_PRI]     : Weather Alert Priority      (0:OFF / 1:ON)

```

Get/Set Weather Priority Settings.
This command is only acceptable in Programming Mode.

```

<COMMAND SGP>
Get/Set SAME Group Settings
Controller → Radio
SGP,[SAME_INDEX] [\r]
SGP,[SAME_INDEX],[NAME],[FIPS1],[FIPS2],[FIPS3],[FIPS4],[FIPS5],[FIPS6],
[FIPS7],[FIPS8] [\r]
Radio → Controller
SGP,[NAME],[FIPS1],[FIPS2],[FIPS3],[FIPS4],[FIPS5],[FIPS6],[FIPS7],[FIPS8] [\r]
SGP,OK[\r]

[SAME_INDEX]: SAME Index      (1 - 5 )
[NAME]      : SAME Group Name (max.16char)
[FIPS1-8]   : FIPS Code (6digit:000000-999999, or ----- means none)

```

Get/Set SAME Group Settings.
In set command, only ", " parameters are not changed.
The set command is aborted if any format error is detected.
This command is only acceptable in Programming Mode.

```

<COMMAND TON>
Get/Set Tone-Out Settings
Controller → Radio
TON,[INDEX][\r]
TON,[INDEX],[NAME],[FRQ],[MOD],[ATT],[DLY],[ALT],[ALTL],[TONE_A],[RSV],
[TONE_B],[RSV],[RSV],[RSV],[RSV],[ALT_PATTERN],[RSV],[RSV],
[RSV][\r]
Radio → Controller
TON,[INDEX],[NAME],[FRQ],[MOD],[ATT],[DLY],[ALT],[ALTL],[TONE_A],[RSV],
[TONE_B],[RSV],[RSV],[RSV],[RSV],[ALT_PATTERN],[RSV],[RSV],
[RSV][\r]
TON,OK[\r]

```

```

[INDEX]      : Index                (1-9,0 means 10)
[NAME]       : Name                  (max.16char)
[FRQ]        : Channel Frequency
[MOD]        : Modulation            (AUTO / FM / NFM)
[ATT]        : Attenuation           (0:OFF / 1:ON)
[DLY]        : Delay Time            (0,1,2,5,10,30 / INF : Infinite)
[ALT]        : Alert Tone            (0:OFF/1-9:Tone No.)
[ALTL]       : Alert Tone Level      (0:AUTO/1-15)
[TONE_A]     : Tone A Frequency
                ex.) 10000 means 1000.0Hz
                00000 means 0.0Hz
[RSV]        : Reserve Parameter     * This is always only "",".
[TONE_B]     : Tone B Frequency
[ALT_PATTERN]: Alert Light Pattern(0:ON / 1:Slow / 2:Fast)

```

Get/Set Tone-Out Settings.
This command is only acceptable in Programming Mode.

```

<COMMAND CNT>
Get/Set LCD Contrast Settings
Controller → Radio
CNT[\r]
CNT,[CONTRAST][\r]
Radio → Controller
CNT,[CONTRAST][\r]
CNT,OK[\r]

```

```

[CONTRAST]      : LCD Contrast          (1 - 15)

```

Get/Set LCD Contrast Settings.
This command is only acceptable in Programming Mode.

<COMMAND SCN>

Get/Set Scanner Option Settings

Controller → Radio

SCN[\r]

SCN, [DISP_MODE], [RSV], [CH_LOG], [G_ATT], [RSV], [RSV] [RSV], [RSV], [RSV],
[RSV], [RSV], [RSV], [RSV], [RSV], [RSV], [RSV], [RSV], [RSV], [RSV], [RSV] [\r]

Radio → Controller

SCN, [DISP_MODE], [RSV], [CH_LOG], [G_ATT], [RSV], [RSV], [RSV], [RSV], [RSV], [RSV],
[RSV], [RSV], [RSV], [RSV], [RSV], [RSV], [RSV], [RSV], [RSV], [RSV], [RSV] [\r]

SCN,OK[\r]

[DISP_MODE] : DISPLAY MODE (1:MODE1 / 2:MODE2 / 3:MODE3)
[CH_LOG] : Control Channel Logging (0:OFF / 1:ON / 2:Extend)
[G_ATT] : Global attenuator (0: OFF / 1: ON)
[RSV] : Reserve Parameter * This is always only ",".

Get/Set Scanner Option Settings

This command is only acceptable in Programming Mode.

<COMMAND VOL>

Get/Set Volume Level Settings

Controller → Radio

VOL[\r]

VOL, [LEVEL] [\r]

Radio → Controller

VOL, [LEVEL] [\r]

VOL,OK[\r]

[LEVEL] : Volume Level (0 - 15)

<COMMAND SQL>

Get/Set Squelch Level Settings

Controller → Radio

SQL[\r]

SQL, [LEVEL] [\r]

Radio → Controller

SQL, [LEVEL] [\r]

SQL,OK[\r]

[LEVEL] : Squelch Level (0:OPEN / 1-14 / 15:CLOSE)

```

<COMMAND DBC>
Get/Set Default Band Coverage Settings
Controller → Radio
DBC, [BNAD_NO] [\r]
DBC, [BNAD_NO], [STEP], [MOD] [\r]

```

```

Radio → Controller
DBC, [STEP], [MOD] [\r]
DBC, OK [\r]

```

```

[BAND_NO]          : Band No (1-31)
                    Band number of band coverage
[STP]              : Search Step
    500   : 5k       625   : 6.25k   750   : 7.5 k
    833   : 8.33k   1000  : 10k     1250  : 12.5k
    1500  : 15k     2000  : 20k     2500  : 25k
    5000  : 50k     10000 : 100k
[MOD]             : Modulation      (AM / NFM / FM / WFM / FMB)

```

This command is only acceptable in Programming Mode.

```

<COMMAND GDO>
Get/Set GPS Disp Option
Controller → Radio
GDO [\r]
GDO, [DISP_MODE], [UNIT], [TIME_FORMAT], [TIME_ZONE], [POS_FORMAT] [\r]
Radio → Controller
GDO, [DISP_MODE], [UNIT], [TIME_FORMAT], [TIME_ZONE], [POS_FORMAT] [\r]
GDO, OK [\r]

```

```

[DISP_MODE] : Display GPS Mode
              ( 0:ETA / 1:Clock / 2:Elevation / 3:Speed / 4:Location )
[UNIT]       : Distance Unit      ( 0: mile / 1: km )
[TIME_FORMAT]: Time Format         ( 0: 12 H / 1: 24H)
[TIME_ZONE]  : Time Zone (-14.0/-13.5/.../-0.5/0.0/0.5/.../13.5/14.0)
              ex) "-14.0" means "- 14.0 H".
[POS_FORMAT]: Position Format      ( DMS / DEG )

```

This command is only acceptable in Programming Mode.

```

<COMMAND BSP>
Get/Set Band Scope System Settings
Controller → Radio
BSP[\r]
BSP, [FRQ], [STP], [SPN], [MAX_HOLD] [\r]
Radio → Controller
BSP, [FRQ], [STP], [SPN], [MAX_HOLD] [\r]
BSP,OK[\r]
    [FRQ]                : Center Frequency
    [STP]                : Search Step
        500      : 5k          625      : 6.25k          750      : 7.5 k
        833      : 8.33k       1000     : 10k           1250     : 12.5k
        1500     : 15k         2000     : 20k           2500     : 25k
        5000     : 50k         10000    : 100k
    [SPN]                : Sweep Span
        0.2M,     0.4M,       0.6M,
        0.8M,     1M,         2M,
        4M,       6M,         8M,
        10M,     20M,        40M,
        60M,     80M,        100M,
        120M,    140M,       160M,
        180M,    200M,       250M,
        300M,    350M,       400M,
        450M,    500M
    [MAX_HOLD]          : Max Hold Display          (0:OFF / 1:ON)

```

Get/Set Band Scope System Settings.
 In set command, only "," parameters are not changed.
 The set command is aborted if any format error is detected.

This command is only acceptable in Programming Mode.

```

<COMMAND GIE>
Get Global IF exchange Frequency
Controller → Radio
GIE [\r]
Radio → Controller
GIE, [FRQ] [\r]
GIE, -1 [\r]

    [FRQ]                : IF Exchange Frequency          (250000-13000000)

```

This command is used to get Global IF exchange frequency list.
 You should call this command again and again to get all global IF exchange frequencies until the scanner returns "-1".
 "-1" means that no more IF exchange frequency exists.
 This command is only acceptable in Programming Mode.

```
<COMMAND CIE>
Clear IF exchange Frequency
Controller → Radio
CIE,[FRQ][\r]
Radio → Controller
CIE,OK[\r]
```

[FRQ] : IF Exchange Frequency (250000-13000000)

This command clear Frequency from Global IF exchange Frequency list.
This command is only acceptable in Programming Mode.

```
<COMMAND RIE>
Register IF exchange Frequency
Controller → Radio
RIE,[FRQ][\r]
Radio → Controller
RIE,OK[\r]
```

[FRQ] : IF Exchange Frequency (250000-13000000)

This command register Frequency to Global IF exchange Frequency list.
This command is only acceptable in Programming Mode.

```
<COMMAND BAV>
*Get Battery Voltage

Controller → Radio
BAV[\r]
Radio → Controller
BAV,####[\r] : A/D Value (0-1023)
```

Battery Level[V] = (3.2[V] * #### * 2)/1023

Returns current battery voltage.
This command is for test mode.

```
<COMMAND WIN>
*Get Window Voltage
Controller → Radio
WIN[\r]
Radio → Controller
WIN,###,[FRQ][\r] : ### : A/D Value (0-255)
```

Returns current window voltage and its frequency.
The order of the frequency digits is from 1 GHz digit to 100 Hz digit.
This command is for test mode.

CTCSS/DCS CODE LIST

CTCSS

MODE	CODE
CTCSS 67.0Hz	64
CTCSS 69.3Hz	65
CTCSS 71.9Hz	66
CTCSS 74.4Hz	67
CTCSS 77.0Hz	68
CTCSS 79.7Hz	69
CTCSS 82.5Hz	70
CTCSS 85.4Hz	71
CTCSS 88.5Hz	72
CTCSS 91.5Hz	73
CTCSS 94.8Hz	74
CTCSS 97.4Hz	75
CTCSS 100.0Hz	76
CTCSS 103.5Hz	77
CTCSS 107.2Hz	78
CTCSS 110.9Hz	79

CTCSS 114.8Hz	80
CTCSS 118.8Hz	81
CTCSS 123.0Hz	82
CTCSS 127.3Hz	83
CTCSS 131.8Hz	84
CTCSS 136.5Hz	85
CTCSS 141.3Hz	86
CTCSS 146.2Hz	87
CTCSS 151.4Hz	88
CTCSS 156.7Hz	89
CTCSS 159.8Hz	90
CTCSS 162.2Hz	91
CTCSS 165.5Hz	92
CTCSS 167.9Hz	93
CTCSS 171.3Hz	94
CTCSS 173.8Hz	95
CTCSS 177.3Hz	96

CTCSS 179.9Hz	97
CTCSS 183.5Hz	98
CTCSS 186.2Hz	99
CTCSS 189.9Hz	100
CTCSS 192.8Hz	101
CTCSS 196.6Hz	102
CTCSS 199.5Hz	103
CTCSS 203.5Hz	104
CTCSS 206.5Hz	105
CTCSS 210.7Hz	106
CTCSS 218.1Hz	107
CTCSS 225.7Hz	108
CTCSS 229.1Hz	109
CTCSS 233.6Hz	110
CTCSS 241.8Hz	111
CTCSS 250.3Hz	112
CTCSS 254.1Hz	113

DCS

MODE	CODE
DCS 023	128
DCS 025	129
DCS 026	130
DCS 031	131
DCS 032	132
DCS 036	133
DCS 043	134
DCS 047	135
DCS 051	136
DCS 053	137
DCS 054	138
DCS 065	139
DCS 071	140
DCS 072	141
DCS 073	142
DCS 074	143
DCS 114	144
DCS 115	145
DCS 116	146
DCS 122	147
DCS 125	148
DCS 131	149
DCS 132	150
DCS 134	151
DCS 143	152
DCS 145	153
DCS 152	154
DCS 155	155
DCS 156	156
DCS 162	157
DCS 165	158
DCS 172	159
DCS 174	160
DCS 205	161
DCS 212	162
DCS 223	163
DCS 225	164
DCS 226	165

DCS 243	166
DCS 244	167
DCS 245	168
DCS 246	169
DCS 251	170
DCS 252	171
DCS 255	172
DCS 261	173
DCS 263	174
DCS 265	175
DCS 266	176
DCS 271	177
DCS 274	178
DCS 306	179
DCS 311	180
DCS 315	181
DCS 325	182
DCS 331	183
DCS 332	184
DCS 343	185
DCS 346	186
DCS 351	187
DCS 356	188
DCS 364	189
DCS 365	190
DCS 371	191
DCS 411	192
DCS 412	193
DCS 413	194
DCS 423	195
DCS 431	196
DCS 432	197
DCS 445	198
DCS 446	199
DCS 452	200
DCS 454	201
DCS 455	202
DCS 462	203
DCS 464	204

DCS 465	205
DCS 466	206
DCS 503	207
DCS 506	208
DCS 516	209
DCS 523	210
DCS 526	211
DCS 532	212
DCS 546	213
DCS 565	214
DCS 606	215
DCS 612	216
DCS 624	217
DCS 627	218
DCS 631	219
DCS 632	220
DCS 654	221
DCS 662	222
DCS 664	223
DCS 703	224
DCS 712	225
DCS 723	226
DCS 731	227
DCS 732	228
DCS 734	229
DCS 743	230
DCS 754	231

FONT DATA

Character pattern of 8 x 16 dot

This character pattern is Large Font.

*In this document, characters of these areas are described as normal characters.

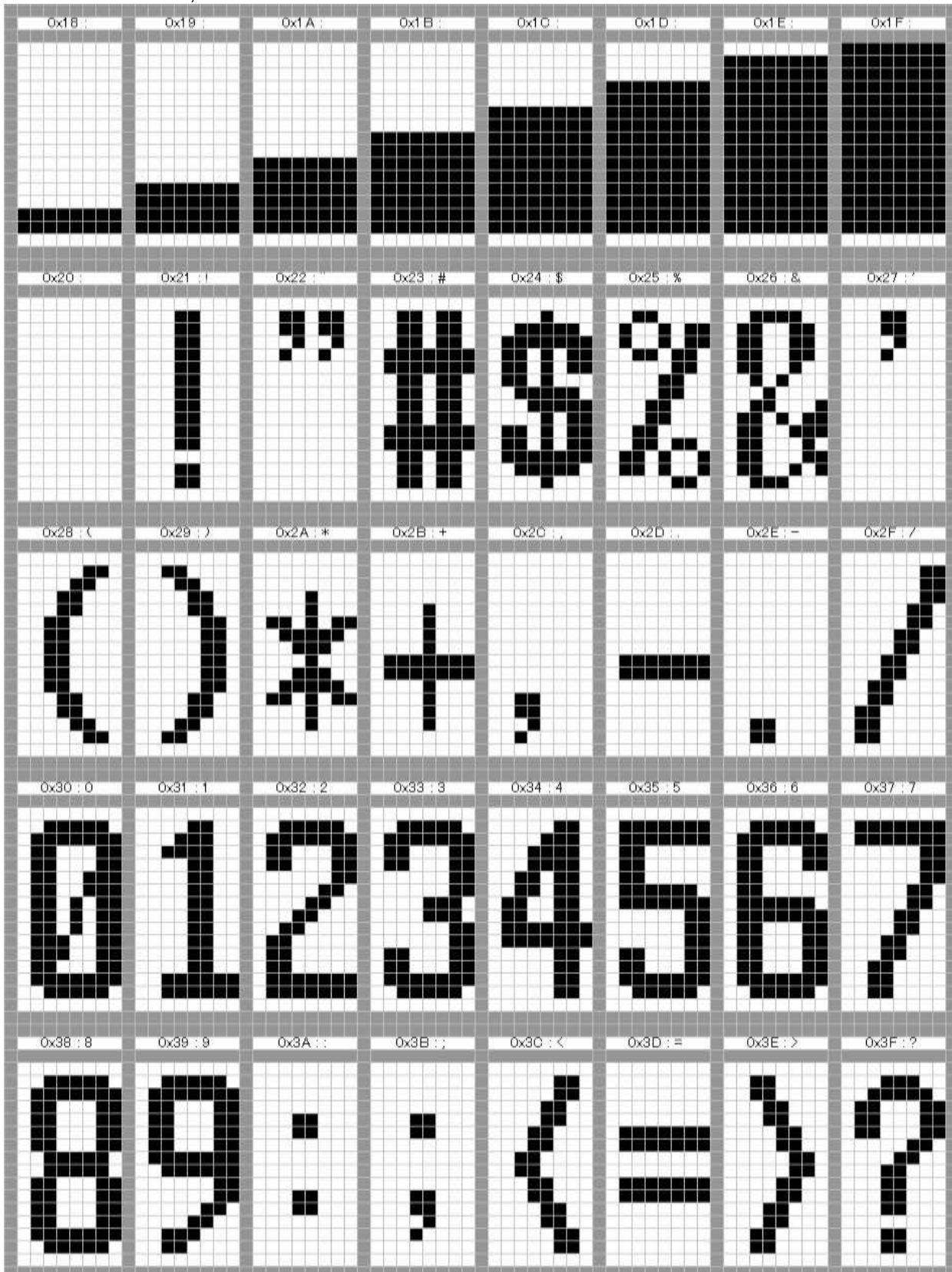



0x68 : h	0x69 : i	0x6A : j	0x6B : k	0x6C : l	0x6D : m	0x6E : n	0x6F : o
0x70 : p	0x71 : q	0x72 : r	0x73 : s	0x74 : t	0x75 : u	0x76 : v	0x77 : w
0x78 : x	0x79 : y	0x7A : z	0x7B : {	0x7C :	0x7D : }	0x7E : ~	0x7F :
0x80 : █	0x81 : ↑	0x82 : ↓	0x83 :	0x84 : ↙	0x85 : ↘	0x86 : ↙	0x87 : ↘
0x88 :	0x89 : ↙	0x8A : ↘	0x8B :	0x8C :	0x8D : ↙	0x8E : ↘	0x8F : ↙

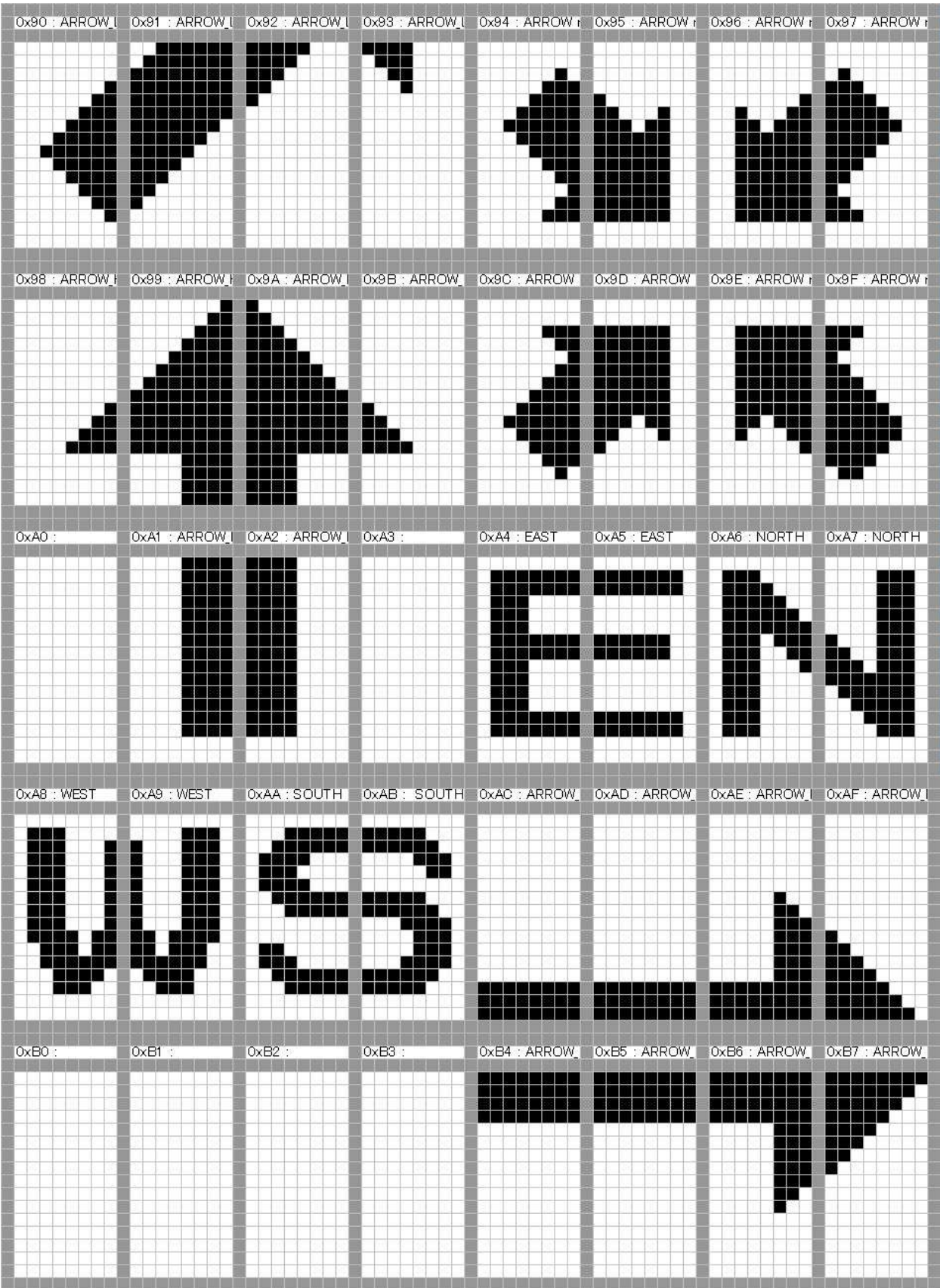

0xB8 : ARROW_	0xB9 : ARROW_	0xBA : ARROW_	0xBB :	0xBC : ARROW	0xBD : ARROW	0xBE : ARROW	0xBF : ARROW
0xC0 : ARROW_	0xC1 : ARROW_	0xC2 : ARROW_	0xC3 : ARROW_	0xC4 : ARROW	0xC5 : ARROW	0xC6 : ARROW	0xC7 : ARROW
0xC8 : ARROW_	0xC9 : ARROW_	0xCA : ARROW_	0xCB : ARROW_	0xCC :	0xCD :	0xCE :	0xCF :
0xD0 : ARROW_	0xD1 : ARROW_	0xD2 : ARROW_	0xD3 : ARROW_	0xD4 : FUNC	0xD5 : BAR R1	0xD6 : BAR R2	0xD7 : BAR R3
0xD8 : ARROW_	0xD9 : ARROW_	0xDA : ARROW_	0xDE : ARROW_	0xDC : BAR R4	0xDD : L/O	0xDE : L/O	0xDF : L/O

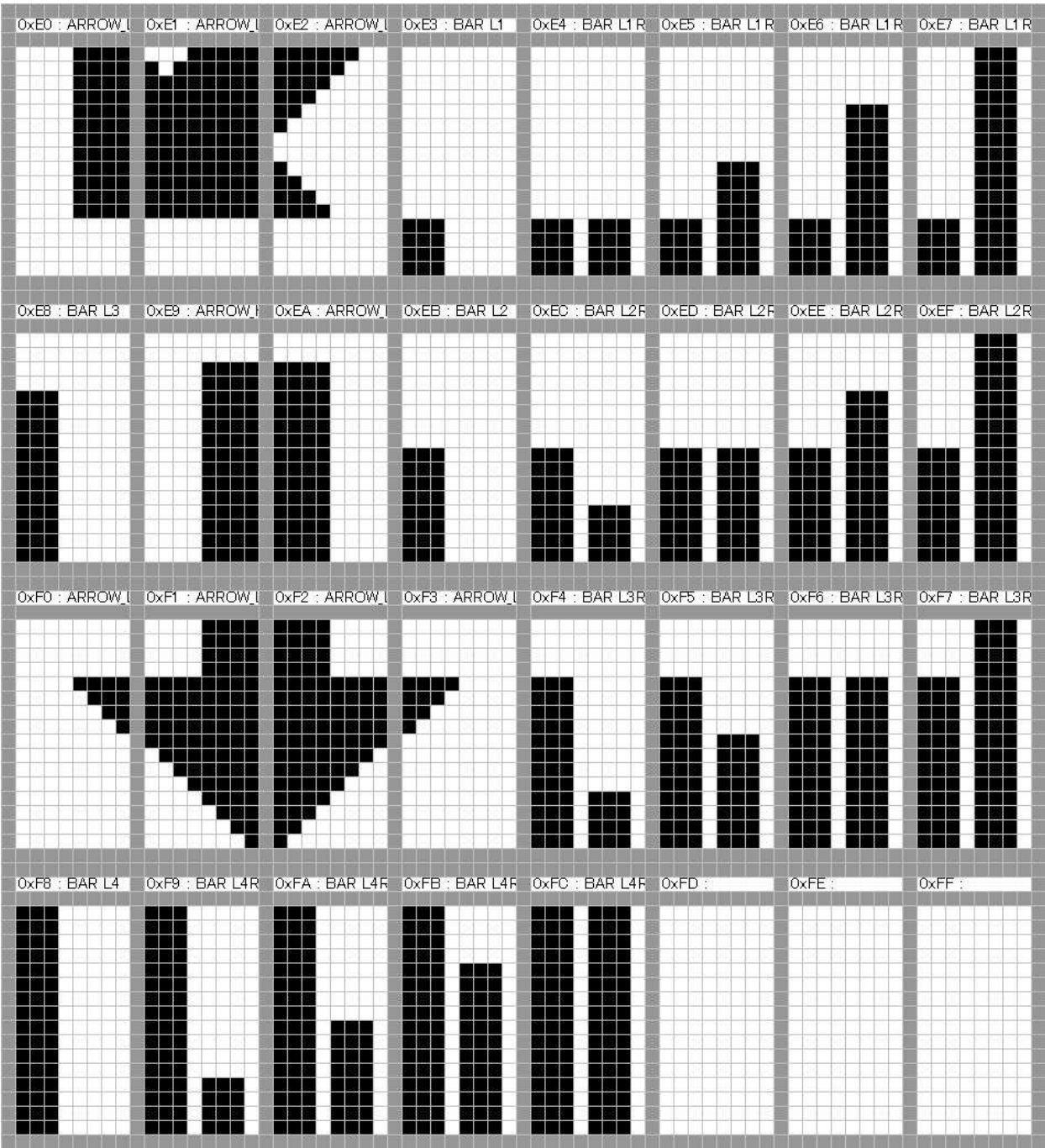

Character pattern of 8 x 8 dot

This character pattern is Small Font.





