

[Uniden Scanners Users Guides](#)

The web pages on this CD provide a guide to setting up and using your scanner. Note that we are continuously updating and improving the content on the live web site. We encourage you to visit us there at [Uniden's Online Scanner Manuals](#).

Note: The information on this CD is as complete as we could make it at the time of production release. There are some pages still under construction for other models included on this CD. Additionally, it is possible that pages on this CD have been updated or improved since production release.

This page contains links to the main procedures you use to program any of the supported scanners. More information specific to each scanner is included in the "Individual Scanners" links. To program things into your scanner, start with the *Setting Up Radio Systems in your Scanner* links below.

- [Individual Scanners](#)
- [Setting up radio systems in your scanner](#)
 - [Digital scanners only](#)
- [General scanning information](#)
- [Legal and Safety Information](#)
 - [General Precautions](#)
 - [FCC Information](#)
 - [Warranty and Support Information](#)
 - [User Guide Information](#)
- [Important Note](#)

Individual Scanners

- [BCD996XT](#)
- [BCT15X](#)
- [BCD396XT](#)
- [BC346XT](#)

Setting up radio systems in your scanner

Please note that these pages are meant as general instructions. While most of the information here applies to all scanners, some options may not be available on certain scanner models. Model-specific options are indicated in the text.

- [Conventional Systems](#)
- [EDACS SCAT Systems](#)
- [EDACS Trunked Systems](#)
- [LTR Trunked Systems](#)
- [Motorola Trunked Systems](#)

Digital scanners only

- [Standard P25 Trunked Systems](#)
- [Single Frequency P25 Trunked Systems](#)

General scanning information

Please note that these pages are meant as general instructions. While most of the information here applies to all scanners, some options may not be available on certain scanner models. Model-specific options are indicated in the text.

- [Radio Systems Overview](#)
- [Deciphering Trunked Systems](#)
- [Location-based Scanning](#)
- [Scanning Legally](#)

Legal and Safety Information

[General Precautions](#)

[FCC Information](#)

[Warranty and Support Information](#)

[User Guide Information](#)

Important Note

This guide is optimized for the following web browsers:

- [Internet Explorer 7.0](#) and later
- [Mozilla Firefox 3.0](#) and later
- [Google Chrome](#)
- [Safari 3.1.2](#)
- [Opera 9.61](#)

If you have difficulty viewing this guide in your current browser, please try downloading one of the browsers listed.

Except as otherwise noted, this page applies to the following scanners: [BCD996XT](#)
[BCT15X](#) [BCD396XT](#) [BC346XT](#) [Users Guide](#)

BCD996XT

- [Important information](#)
 - [General Precautions](#)
 - [Feature List](#)
 - [Specifications](#)
 - [FCC Information](#)
 - [Warranty and Support Information](#)
 - [User Guide Information](#)
- [Operation overview](#)
- [Setting up the hardware](#)
- [Programming your scanner](#)
- [Operating your scanner](#)



Important information

For general information about using a scanner, including how to program the various types of radio systems into your scanner, we suggest you start with the [General Users Guide](#) page.

[General Precautions](#)

[Feature List](#)

Specifications

- [Hardware specifications](#)
- [Software reference is available from our web site](#)

[FCC Information](#)

[Warranty and Support Information](#)

[User Guide Information](#)

Operation overview

- [Available operation modes](#)
- [Menu reference](#)
- [Keys and their functions](#)
- [Reading the display](#)

Setting up the hardware

- [Included with the scanner](#)
- [Connecting the antenna](#)
- [Connecting a GPS receiver](#)

Programming your scanner

- [Setting up systems](#)
- [Programming Number Tags](#)
- [Programming Quick Keys](#)
- [Programming Search Keys](#)
- [Programming locations](#)
- [Setting alerts](#)

Operating your scanner

- [Using Number Tags](#)
- [Using Quick Keys, Startup Keys, and Search Keys](#)
- [Using Tone Out mode](#)
- [Using Close Call mode](#)
- [Using Band Scope mode](#)
- [Using GPS mode](#)

This page applies to the following scanner(s): [BCD996XT Users Guide](#)

NEED TO ADD

BCD396XT

- [Important information](#)
 - [General Precautions](#)
 - [Specifications](#)
 - [FCC Information](#)
 - [Warranty and Support Information](#)
 - [User Guide Information](#)
- [Operation overview](#)
- [Setting up the hardware](#)
- [Programming your scanner](#)
- [Operating your scanner](#)

Important information

For general information about using a scanner, we suggest you start with the [General Users Guide](#) page.

[General Precautions](#)

Specifications

- [Hardware specifications](#)
- [Software reference](#)

[FCC Information](#)



[Warranty and Support Information](#)

[User Guide Information](#)

Operation overview

- [Available operation modes](#)
- [Menu reference](#)
- [Keys and their functions](#)
- [Reading the display](#)



Setting up the hardware

- [Included with the scanner](#)
- [Installing the batteries](#)
- [Connecting the antenna](#)
- [Attaching the belt clip](#)
- [Connecting a GPS receiver](#)

Programming your scanner

- [Setting up systems](#)
- [Programming Number Tags](#)
- [Programming Quick Keys](#)
- [Programming Search Keys](#)

- [Programming locations](#)
- [Setting alerts](#)

Operating your scanner

- [Using Number Tags](#)
- [Using Quick Keys, Startup Keys, and Search Keys](#)
- [Using Tone Out mode](#)
- [Using Close Call mode](#)
- [Using Band Scope mode](#)
- [Using GPS mode](#)

This page applies to the following scanner(s): [BCD396XT Users Guide](#)

BC346XT

- [Important information](#)





- [General Precautions](#)
- [Specifications](#)
- [FCC Information](#)
- [Warranty and Support Information](#)
- [User Guide Information](#)
- [Operation overview](#)
- [Setting up the hardware](#)
- [Programming your scanner](#)
- [Operating your scanner](#)

Important information

For general information about using a scanner, we suggest you start with the [General Users Guide](#) page.

[General Precautions](#)

Specifications

- [Hardware specifications](#)
- [Software reference](#)

[FCC Information](#)

[Warranty and Support Information](#)

[User Guide Information](#)

Operation overview

- [Available operation modes](#)
- [Menu reference](#)
- [Keys and their functions](#)
- [Reading the display](#)

Setting up the hardware

- [Included with the scanner](#)
- [Installing the batteries](#)
- [Connecting the antenna](#)
- [Attaching the belt clip](#)
- [Connecting a GPS receiver](#)

Programming your scanner

- [Setting up systems](#)
- [Programming Number Tags](#)
- [Programming Quick Keys](#)
- [Programming Search Keys](#)
- [Programming locations](#)
- [Setting alerts](#)

Operating your scanner

- [Using Number Tags](#)
 - [Using Quick Keys, Startup Keys, and Search Keys](#)
 - [Using Tone Out mode](#)
 - [Using Close Call mode](#)
 - [Using Band Scope mode](#)
 - [Using GPS mode](#)
-

This page applies to the following product(s): [BC346XTUser Guide](#)

[Conventional Systems](#)

Please note that these pages are meant as general instructions. While most of the information here applies to all scanners, some options may not be available on certain scanner models. Model-specific options are indicated in the text.

Since a conventional system is really a collection of frequencies, the first thing you need to know is the frequency for each channel you want to program. Here is an example of a conventional system frequency list from [RadioReference](#):

Frequency	Input	License	Type	Tone	Alpha Tag	Description	Mode	Tag
146.94000	146.34000	K5FTW-R	RM	110.9 PL	TC RACES Pri	Tarrant County RACES/Skywarn Primary	FM	Ham
146.76000	146.16000	K5FTW-R	RM	110.9 PL	TC RACES B/U	Tarrant County RACES/Skywarn Backup	FM	Ham
444.10000	449.10000	K5FTW-R	RM	110.9 PL	TC RACES Adm	Tarrant County Backup / Admin / Secondary Net Freq.	FM	Ham
224.94000	223.34000	K5FTW-R	RM	110.9 PL	TC RACES Int	Tarrant County Admin Freq. / WX Service Intercom Freq.	FM	Ham

Conventional System

- Here is a [conceptual layout diagram](#) of a basic conventional system. ([Click here](#) for a legend of the diagram.)
- You can download a planning worksheet for conventional systems as a [pdf file](#) or an [Excel spreadsheet file](#).
- [Programming a Conventional System](#)
 - [Create a system](#)
 - [System properties](#)
 - [Create at least 1 channel group](#)
 - [Channel group properties](#)
 - [Create at least 1 channel in each group](#)
 - [Channel properties](#)

Programming a Conventional System

To program a conventional system, you'll need to program the required elements in following order ([click here for information on using the menu](#)):

Create a system

1. Go to the [Program System](#) menu and choose *New System* .
2. The scanner will prompt you for the System Type. Select *Conventional* .
3. When the scanner prompts you confirm, tap **YES** .
4. The scanner creates the system with a default name. Select [Edit Name](#) if you want to change it.
5. If you need to change any of the system properties, you can do that now. Unless a property is *Required* , you can operate the system without changing the default settings.

System properties

All of these options can be found under your scanner's [Program System](#) menu. If necessary, the sub-menu and option name on each scanner are listed beside the property.

Property	Option name
Required	
None	
Recommended	
Name	Edit Name
Number tag	Set Number Tag
Quick key	Set Quick Key
Optional	
Record Flag	BCD996XT and BCT15X : Set Record BCD396XT and BC346XT : Not available
Automatic Gain Control (AGC)	BCD396XT and BCD996XT : Set Audio AGC BC346XT and BCT15X : Not available
Delay time	Set Delay Time
Hold time	Set Hold Time
Lockout	Set Lockout
P25 wait time	BCD396XT and BCD996XT : P25 Waiting Time BC346XT and BCT15X : Not available
Startup key	Set Startup Key
Available operations	
Copy a system	Copy System
Delete a system	Delete System

Create at least 1 channel group

Each conventional system can contain up to 20 channel groups, and all systems must contain at least 1 channel group.

1. On the [Program System](#) menu, select the system you just created.
2. Go to the [Edit Group](#) menu and select *New Group* .
3. If you need to change any of the channel group properties, you can do that now. Unless a property is *Required* , you can operate the system without changing the default settings.

Channel group properties

All of these options can be found by selecting the group name under your scanner's [Edit Group](#) menu. If necessary, the sub-menu and option name on each scanner are listed beside the property.

Property	Option name

Required	
None	
Recommended	
Name	Edit Name
Quick key	Set Quick Key
Optional	
Location information	Set Location Info
Lockout	Set Lockout
Available operations	
Delete a group	Delete Group

Create at least 1 channel in each group

Each conventional system can contain up to 1000 channels in each group, and all groups must contain at least 1 channel.

1. On the [Edit Group](#) menu, select the channel group you just created.
2. Go to the [Edit Channel](#) menu and select *New Channel* .
3. Input the frequency for this channel in MHz.
4. If you need to change any of the channel properties, you can do that now. Unless a property is *Required* , you can operate the system without changing the default settings.

Channel properties

(All of these options can be found by selecting the channel name your scanner's [Edit Channel](#) menu. If necessary, the sub-menu and the exact option name are listed beside each property.)

Property	Option name
Required	
Frequency	Edit Frequency
Recommended	
Analog/digital	BCD396XT and BCD996XT : Set Audio Type BC346XT and BCT15X : Not available
<ul style="list-style-type: none"> • CTCSS/DCS 	Set CTCSS/DCS (BCD396XT : analog channels only)

<ul style="list-style-type: none"> • P25 Network Address (NAC) 	<p>BCD396XT and BCD996XT: P25 NAC Option (digital channels only)</p> <p>BC346XT and BCT15X: Not available</p>
Modulation	Set Modulation
Name	Edit Name
Number tag	Set Number Tag
Optional	
Alert	Set Alert
Record	<p>BCD996XT and BCT15: Set Record</p> <p>BCD396XT and BC346XT: Not available.</p>
Attenuator	Set Attenuator
Lockout	Set Lockout
Priority	Set Priority
Volume Offset	Volume Offset
Available operations	
Copy a channel	Copy Channel
Delete a channel	Delete Channel

This page applies to the following scanner(s): [BCD996XT](#) [BCT15X](#) [BCD396XT](#) [BC346XT](#)
[UsersGuide](#)

EDACS SCAT Systems

Please note that these pages are meant as general instructions. While most of the information here applies to all scanners, some options may not be available on certain scanner models. Model-specific options are indicated in the text.

This section deals with EDACS SCAT systems. [Click here for information on EDACS Wide and Narrow systems.](#) Below is an example of an EDACS SCAT system from [RadioReference](#):

System Name:	Medley City Public Safety
Location:	Medley, FL
County:	Dade
System Type:	EDACS SCAT
System Voice:	Analog
Last Updated:	<i>Updated Function Tag assignments for 1 talkgroups</i>
Hits:	1742

System Frequencies

Red (c) are Primary Control Channels | Blue (a) are alternate control channels | Click a Site Name for additional site information | Site Map: [FCC Callsigns](#) [RR Locations](#)

Site Name
000 Police 01 855.13750c

System Talkgroups

Updated in the last 7 days
 Updated in the last 24 hours
 [List All](#) in one table
 [Show New](#) Talkgroups

POLICE Talkgroups ▶

DEC	AFS	Mode	Alpha Tag	Description	Tag
100	00-124	A	DISPATCH	Police Dispatch	Law Dispatch

150 px

And here is a [conceptual layout diagram](#) of a basic EDACS SCAT system. ([Click here](#) for a legend of the diagram.)

- [Programming an EDACS SCAT System](#)
 - [Create a system](#)
 - [System properties](#)
 - [Create a site](#)
 - [Site properties](#)
 - [Create at least 1 frequency](#)
 - [Frequency properties](#)

Programming an EDACS SCAT System

To program an EDACS SCAT system, you'll need to program the required elements in following order ([click here for information on using the menu](#)):

Create a system

1. Go to the [Program System](#) menu and choose *New System* .
2. The scanner will prompt you for the System Type. Select *EDCS* .
3. The scanner will prompt you for the sub-type. Select *SCAT* .
4. When the scanner prompts you confirm, tap **YES** .
5. The scanner creates the system with a default name. Select [Edit Name](#) if you want to change it.
6. If you need to change any of the system properties, you can do that now. Unless a property is *Required* , you can operate the system without changing the default settings.

System properties

All of these options can be found under your scanner's [Program System](#) menu. If necessary, the sub-menu and option name on each scanner are listed beside the property.

Property	Option name
	Required
None	
	Recommended

Name	Edit Name
Number tag	Set Number Tag
Optional	
Record	BCD996XT or BCT15X : Set Record BCD396XT or BC346XT : Not available
Automatic Gain Control (AGC)	BCD396XT or BCD996XT : Set Audio AGC BC346XT or BCT15: Not available
Delay time	Set Delay Time
Available operations	
Copy a system	Copy System
Delete a system	Delete System

Create a site

Each EDACS SCAT system must contain exactly 1 site.

1. On the [Program System](#) menu, select the system you just created.
2. Go to the [Edit Site](#) menu.
3. If you need to change any of the site properties, you can do that now. Unless a property is *Required*, you can operate the system without changing the default settings.

Site properties

All of these options can be found under your scanner's [Edit Site](#) menu. If necessary, the sub-menu and option name on each scanner are listed beside the property.

Property	Option name
Required	
None	
Recommended	
Quick key	Set Quick Key
Optional	
Attenuator	Set Attenuator
Hold time	Set Hold Time
Location information	Set Location Info
Lockout	Set Lockout
Modulation	Set Modulation
Startup key	Set Startup Key
Available operations	
None	

Create at least 1 frequency

Each EDACS SCAT system must contain at least 1 frequency in its site.

1. Open the [Edit Site](#) menu.
2. Go to the [Set Frequencies](#) sub-menu and select *New Frequency*.
3. Enter at least 1 frequency for this site.
4. If you need to change any of the frequency properties, you can do that now. Unless a property is *Required*, you can operate the system without changing the default settings.

Frequency properties

All of these options can be found by selecting the frequency under the [Set Frequencies](#) sub-menu. If necessary, the sub-menu and option name on each scanner are listed beside the property.

Property	Option name
Required	
None	
Recommended	
Number tag	Set Number Tag
Optional	
Record	BCD996XT or BCT15X: Set Record BCD396XT or BC346XT : Not available.
Lockout	Set Lockout
Available operations	
Delete a frequency	Delete Frequency

This page applies to the following scanner(s): [BCD996XT](#) [BCT15X](#) [BCD396XT](#) [BC346XT](#) [Users Guide](#)

EDACS Trunked Systems

Please note that these pages are meant as general instructions. While most of the information here applies to all scanners, some options may not be available on certain scanner models. Model-specific options are indicated in the text.

This section deals with EDACS Wide or standard systems. [Click here for information on EDACS SCAT systems](#). This includes EDACS systems that use ESK. No special setting is needed to enable ESK tracking on an EDACS system. Note that the scanner cannot decode EDACS ProVoice. Below is an example of an EDACS trunked system from [RadioReference](#):

System Name:	Irving Public Safety System
Location:	Irving, TX
County:	Dallas
System Type:	EDACS Standard
System Voice:	Analog
Last Updated:	11-08-2007 03:40

System Frequencies		<small>Red* are Primary Control Channels Blue* are Secondary Control Channels</small>							
Site	Description								
001	Primary	01-868.53750*	02-868.08750	03-868.58750	04-855.46250	05-868.63750	06-857.21250	07-868.73750	
		08-868.83750	09-866.58750	10-868.91250					

EDACS Wide System

- Here is a [conceptual layout diagram](#) of a basic EDACS Wide system. ([Click here](#) for a legend of the diagram.)
- You can download a planning worksheet for EDACS systems as a [pdf file](#) or an [Excel spreadsheet file](#).
- [Programming an EDACS System](#)
 - [Create a system](#)
 - [System properties](#)
 - [Create at least 1 site](#)
 - [Site properties](#)
 - [Create at least 1 frequency in each site](#)
 - [Frequency properties](#)
- [Programming a system for Scanning](#)
 - [Create at least 1 channel group](#)
 - [Channel group properties](#)
 - [Create at least 1 channel in each group](#)

- [Channel properties](#)

Programming an EDACS System

To program an EDACS system, you'll need to program the required elements in following order ([click here for information on using the menu](#)):

Create a system

1. Go to the [Program System](#) menu and choose *New System* .
2. The scanner will prompt you for the System Type. Select *EDCS* .
3. The scanner will prompt you for the sub-type. Select *Wide/Narrow* .
4. When the scanner prompts you confirm, tap **YES** .
5. The scanner creates the system with a default name. Select [Edit Name](#) if you want to change it.
6. If you need to change any of the system properties, you can do that now. Unless a property is *Required* , you can operate the system without changing the default settings.

System properties

All of these options can be found under your scanner's [Program System](#) menu. If necessary, the sub-menu and option name on each scanner are listed beside the property.

Property	Option name
Required	
None	
Recommended	
Name	Edit Name
Number tag	Set Number Tag
Optional	
Automatic Gain Control (AGC)	BCD396XT and BCD996XT : Set Audio AGC BC346XT and BCT15X : Not available
Record	BCD996XT and BCT15X : Set Record BCD396XT and BC346XT : Not available
Delay time	Set Delay Time

Emergency alert	Emergency Alert
ID format	Set ID Format (AFS) or (DEC)
ID scan/search	ID Scan/Search
Priority ID scan	Priority ID scan
Available operations	
Copy a system	Copy System
Delete a system	Delete System
Review locked-out IDs	Rvw ID:Srch L/O
Clear all locked-out IDs	Clr All L/O IDs

Create at least 1 site

Each EDACS system can contain up to 256 sites, and all systems must contain at least 1 site.

1. On the [Program System](#) menu, select the system you just created.
2. Go to the [Edit Site](#) menu and select *New Site* .
3. If you need to change any of the site properties, you can do that now. Unless a property is *Required* , you can operate the system without changing the default settings.

Site properties

All of these options can be found under your scanner's [Edit Site](#) menu. If necessary, the sub-menu and option name on each scanner are listed beside the property.

Property	Option name
Required	
Site type	Set Site Type
Recommended	
Name	Edit Name
Quick key	Set Quick Key

Optional	
Attenuator	Set Attenuator
Hold time	Set Hold Time
Location information	Set Location Info
Lockout	Set Lockout
Modulation	Set Modulation
Startup key	Set Startup Key
Available operations	
Delete a site	Delete Site

Create at least 1 frequency in each site

Each trunked system can contain up to 30 frequencies in each site, and all sites must contain at least 1 frequency.

1. On the [Edit Site](#) menu, select the site you just created.
2. Go to the [Set Frequencies](#) sub-menu and select *New Frequency* .
3. Enter at least 1 frequency for this site.
4. When you enter a new frequency, the scanner will prompt you for the [logical channel number or LCN](#) for that frequency. Enter a number from 1 through 30.
5. If you need to change any of the frequency properties, you can do that now. Unless a property is *Required* , you can operate the system without changing the default settings.

Frequency properties

All of these options can be found by selecting the frequency under the [Set Frequencies](#) sub-menu. If necessary, the sub-menu and option name on each scanner are listed beside the property.

Property	Option name
Required	
Logical channel number	Input LCN

Recommended	
None	
Optional	
Lockout	Set Lockout
Available operations	
Delete a frequency	Delete Frequency

Programming a system for Scanning

Once you create the system and at least 1 site, you can [Search](#) the system with no problems. However, if you want to [Scan](#) the system, you'll need to program the required elements in following order ([click here for information on using the menu](#)):

Create at least 1 channel group

Each EDACS system can contain up to 20 channel groups, and any system you want to scan must contain at least 1 channel group.

1. On the [Program System](#) menu, select the system you just created.
2. Go to the [Edit Group](#) menu and select *New Group* .
3. If you need to change any of the channel group properties, you can do that now. Unless a property is *Required* , you can operate the system without changing the default settings.

Channel group properties

All of these options can be found by selecting the group name under your scanner's [Edit Group](#) menu. If necessary, the sub-menu and option name on each scanner are listed beside the property.

Property	Option name
Required	
None	
Recommended	
Name	Edit Name

Quick key	Set Quick Key
Optional	
Location information	Set Location Info
Lockout	Set Lockout
Available operations	
Delete a group	Delete Group

Create at least 1 channel in each group

Each trunked system can contain up to 500 channels.

1. On the [Edit Group](#) menu, select the channel group you just created.
2. Go to the [Edit Channel](#) menu and select *New Channel* .
3. Input the [Talk Group ID \(TGID\)](#) for this channel.
4. If you need to change any of the channel properties, you can do that now. Unless a property is *Required* , you can operate the system without changing the default settings.

Channel properties

All of these options can be found by selecting the channel name your scanner's [Edit Channel](#) menu. If necessary, the sub-menu and option name on each scanner are listed beside the property.

Property	Option name
Required	
TGID	Edit Talk Group ID
Recommended	
Name	Edit Name
Number tag	Set Number Tag
Optional	

Record	BCD996XT and BCT15X : Set Record BCD396XT and BC346XT : Not available.
Alert	Set Alert
Lockout	Set Lockout
Priority	Set Priority
Volume Offset	Volume Offset
Available operations	
Copy a channel	Copy Channel
Delete a channel	Delete Channel

This page applies to the following scanner(s): [BCD996XT](#) [BCT15X](#) [BCD396XT](#) [BC346XT](#)
[UsersGuide](#)

LTR Trunked Systems

Please note that these pages are meant as general instructions. While most of the information here applies to all scanners, some options may not be available on certain scanner models. Model-specific options are indicated in the text.

Below is an example of a Logic Trunked Radio or *LTR* system from [RadioReference](#):

System Name:	American Airlines Center System							
Location:	Dallas, TX							
County:	Dallas							
System Type:	LTR Standard							
System Voice:	Analog							
Last Updated:	08-15-2004 21:23							
System Frequencies								
Site	Description							
001	Site-1	01-461.50000	02-N/A	03-461.70000	04-N/A	05-462.17500	06-N/A	07-463.87500
		08-N/A	09-N/A	10-N/A	11-464.40000	12-N/A	13-N/A	14-463.33750
		15-N/A	16-464.08750	17-N/A	18-464.18750			

LTR System

- Here is a [conceptual layout diagram](#) of a basic LTR system. ([Click here](#) for a legend of the diagram.)
- You can download a planning worksheet for LTR systems as a [pdf file](#) or an [Excel spreadsheet file](#).
- For more information on the different types of LTR systems and how they work, see the [Logic Trunked Radio](#) page at [Radio Reference's Wiki](#).
- [Programming an LTR System](#)
 - [Create a system](#)
 - [System properties](#)
 - [Create at least 1 site](#)
 - [Site properties](#)
 - [Create at least 1 frequency in each site](#)
 - [Frequency properties](#)
- [Programming a system for Scanning](#)
 - [Create a channel group](#)
 - [Channel group properties](#)
 - [Create a channel in each group](#)

- [Channel properties](#)

Programming an LTR System

To program an LTR system, you'll need to program the required elements in following order ([click here for information on using the menu](#)):

Create a system

1. Go to the [Program System](#) menu and choose *New System* .
2. The scanner will prompt you for the System Type. Select *LT* .
3. When the scanner prompts you confirm, tap **YES** .
4. The scanner creates the system with a default name. Select [Edit Name](#) if you want to change it.
5. If you need to change any of the system properties, you can do that now. Unless a property is *Required* , you can operate the system without changing the default settings.

System properties

All of these options can be found under your scanner's [Program System](#) menu. If necessary, the sub-menu and option name on each scanner are listed beside the property.

Property	Option name
Required	
None	
Recommended	
Name	Edit Name
Number tag	Set Number Tag
Optional	
Automatic Gain Control (AGC)	BCD396XT and BCD996XT : Set Audio AGC
	BC346XT and BCT15X : Not available
Record Out	BCD996XT and BCT15X : Set Record
	BCD396XT and BC346XT : Not available

Delay time	Set Delay Time
ID scan/search	ID Scan/Search
Priority ID scan	Priority ID scan
Available operations	
Copy a system	Copy System
Delete a system	Delete System
Review locked-out IDs	Rvw ID:Srch L/O
Clear all locked-out IDs	Clr All L/O IDs

Create at least 1 site

Each LTR system can contain up to 256 sites, and all systems must contain at least 1 site.

1. On the [Program System](#) menu, select the system you just created.
2. Go to the [Edit Site](#) menu and select *New Site* .
3. If you need to change any of the site properties, you can do that now. Unless a property is *Required* , you can operate the system without changing the default settings.

Site properties

All of these options can be found under your scanner's [Edit Site](#) menu. If necessary, the sub-menu and option name on each scanner are listed beside the property.

Property	Option name
Required	
None	
Recommended	
Name	Edit Name
Quick key	Set Quick Key
Optional	

Attenuator	Set Attenuator
Hold time	Set Hold Time
Location information	Set Location Info
Lockout	Set Lockout
Modulation	Set Modulation
Startup key	Set Startup Key
Available operations	
Delete a site	Delete Site

Create at least 1 frequency in each site

Each LTR system can contain up to 20 frequencies in each site, and all sites must contain at least 1 frequency.

1. On the [Edit Site](#) menu, select the site you just created.
2. Go to the [Set Frequencies](#) sub-menu and select *New Frequency* .
3. Enter at least 1 frequency for this site.
4. When you enter a new frequency, the scanner will prompt you for the [logical channel number or LCN](#) for that frequency. Enter a number from 1 through 20.
5. If you need to change any of the frequency properties, you can do that now. Unless a property is *Required* , you can operate the system without changing the default settings.

Frequency properties

All of these options can be found by selecting the frequency under the [Set Frequencies](#) sub-menu. If necessary, the sub-menu and option name on each scanner are listed beside the property.

Property	Option name
Required	
Logical channel number	Input LCN
Recommended	

None	
Optional	
Lockout	Set Lockout
Available operations	
Delete a frequency	Delete Frequency

Programming a system for Scanning

Once you create the system and at least 1 site, you can [Search](#) the system with no problems. However, if you want to [Scan](#) the system, you'll need to program the required elements in following order ([click here for information on using the menu](#)):

Create a channel group

Each LTR system can contain up to 20 channel groups.

1. On the [Program System](#) menu, select the system you just created.
2. Go to the [Edit Group](#) menu and select *New Group* .
3. If you need to change any of the channel group properties, you can do that now. Unless a property is *Required* , you can operate the system without changing the default settings.

Channel group properties

All of these options can be found by selecting the group name under your scanner's [Edit Group](#) menu. If necessary, the sub-menu and option name on each scanner are listed beside the property.

Property	Option name
Required	
None	
Recommended	
Name	Edit Name
Quick key	Set Quick Key

Optional	
Location information	Set Location Info
Lockout	Set Lockout
Available operations	
Delete a group	Delete Group

Create a channel in each group

Each trunked system can contain up to 500 channels.

1. On the [Edit Group](#) menu, select the channel group you just created.
2. Go to the [Edit Channel](#) menu and select *New Channel*.
3. Input the [Talk Group ID \(TGID\)](#) for this channel.
4. If you need to change any of the channel properties, you can do that now. Unless a property is *Required*, you can operate the system without changing the default settings.

Channel properties

All of these options can be found by selecting the channel name your scanner's [Edit Channel](#) menu. If necessary, the sub-menu and option name on each scanner are listed beside the property.

Property	Option name
Required	
TGID	Edit Talk Group ID
Recommended	
Name	Edit Name
Number tag	Set Number Tag
Optional	
Alert	Set Alert
Record Out	BCD996XT and BCT15X : Set Record

	BCD396XT and BC346XT : Not available
Lockout	Set Lockout
Priority	Set Priority
Volume Offset	Volume Offset
Available operations	
Copy a channel	Copy Channel
Delete a channel	Delete Channel

This page applies to the following scanner(s): [BCD996XT](#) [BCT15X](#) [BCD396XT](#) [BC346XT](#) [Users Guide](#)

Motorola Trunked Systems

Please note that these pages are meant as general instructions. While most of the information here applies to all scanners, some options may not be available on certain scanner models. Model-specific options are indicated in the text.

A Motorola system can be an 800 MHz, 400 MHz (UHF), or 100-200 MHz (VHF) system. Below are some examples of these Motorola systems from [RadioReference](#):

System Name:	Grand Prairie System
Location:	Grand Prairie, TX
County:	Dallas
System Type:	Motorola Type II SmartZone
System Voice:	Analog and APCO-25 Common Air Interface
Last Updated:	06-19-2006 16:37

System ID Table		
Sysid	CT	WACN
2515	105.88	

System Frequencies
Red* are Primary Control Channels Blue* are Secondary Control Channels

Site	Description	Freqs								
001	Primary	858.96250	857.96250*	858.96250*	859.96250*	860.96250*	868.23750	868.51250	868.76250	868.96250

Motorola 800 MHz System

System Name:	Arlington System
Location:	Arlington, TX
County:	Tarrant
System Type:	Motorola Type II Smartnet
System Voice:	Analog
Last Updated:	09-12-2006 14:37

System ID Table		
Sysid	CT	WACN
162A	105.88	

System Frequencies
Red* are Primary Control Channels Blue* are Secondary Control Channels

Site	Description	Freqs								
001	Primary	856.48750	856.71250	857.48750	857.71250*	858.48750	858.71250*	859.48750	859.71250*	860.48750
		860.71250*	867.56250	868.26250						

Another Motorola 800 MHz System

- Even though some (or all) of the System Voice channels are APCO 25, this system, and others like it, is correctly programmed as a Motorola 800 MHz system, per the information given for the System Type.

System Name:	United Parcel Service (DFW Airport) System		
Location:	DFW Airport, TX		
County:	2 counties		
System Type:	Motorola Type II Smartnet		
System Voice:	Analog		
Last Updated:	06-04-2007 18:42		

Sysid	CT	WACN
7507	116.13	

Base	Spacing	Offset
461.5000	300	12.5
451.0000	560	12.5

System Frequencies
Red* are Primary Control Channels Blue* are Secondary Control Channels

Site	Description	Freqs								
001	Primary	451.31250	451.66250	451.88750	452.03750	452.53750	452.68750*	452.88750*	462.18750*	462.48750*

Motorola UHF System (400 MHz band)

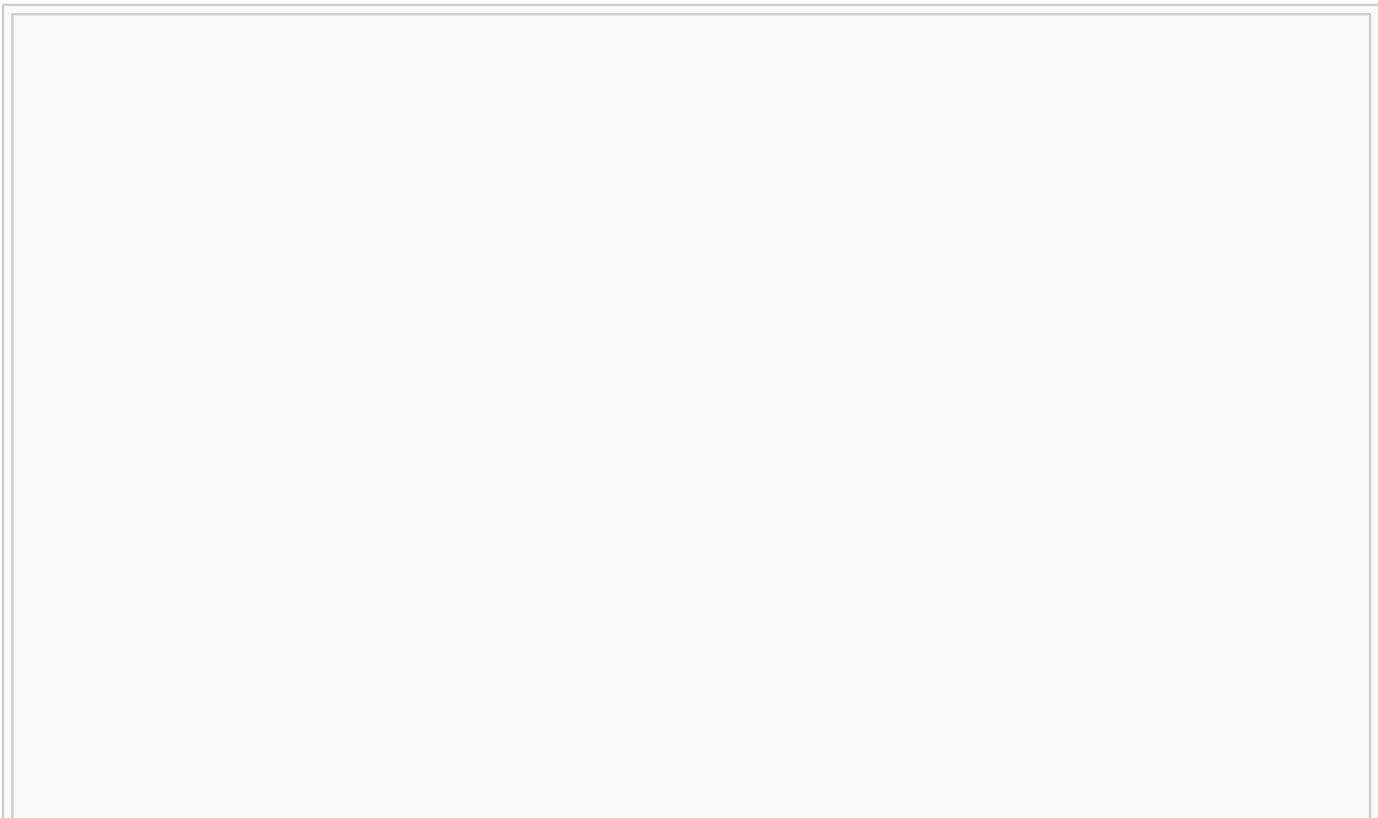

System Name:	Staffordshire Fire & Rescue System
Location:	Staffordshire, EN
County:	Staffordshire
System Type:	Motorola Type II Smartnet
System Voice:	Analog
Last Updated:	02-01-2008 11:17

Sysid	CT	WACN
1533		

Base	Spacing	Offset
152.0000	390	12.5
154.0000	461	12.5

System Frequencies

Red* are Primary Control Channels **Blue*** are Secondary Control Channels

Site	Description	Freqs								
001	North Simulcast	153.82500	154.08750	154.72500	154.88750	155.07500	155.30000	155.41250*	155.43750	155.56250
		155.61250								
002	South Simulcast	152.15000*	152.26250	152.31250	152.53750	152.82500	155.21250	155.52500	155.55000	155.87500
006	Site-6	152.83750	154.08750	154.72500	154.88750	155.07500	155.30000	155.41250*	155.43750	155.56250
		155.81250								
011	Site-11	152.02500*	154.57500	154.75000						

Motorola VHF System (100-200 MHz band)

- Here is a [conceptual layout diagram](#) of a basic Motorola system. ([Click here](#) for a legend of the diagram.)
- You can download a planning worksheet for Motorola systems as a [pdf file](#) or an [Excel spreadsheet file](#).
- For more information on the different types of Motorola systems and how they work, see the [Motorola](#) page at [Radio Reference's Wiki](#).
- [Programming a Motorola System](#)
 - [Create a system](#)
 - [System properties](#)
 - [Create at least 1 site](#)
 - [Site properties](#)
 - [Create at least 1 frequency in each site](#)
 - [Frequency properties](#)
- [Programming a system for Scanning](#)
 - [Create a channel group](#)
 - [Channel group properties](#)
 - [Create a channel](#)
 - [Channel properties](#)

Programming a Motorola System

To program a Motorola system, you'll need to program the required elements in following order:

Create a system

1. Go to the [Program System](#) menu and choose *New System* .
2. The scanner will prompt you for the System Type. Select *MOT* .
3. When the scanner prompts you confirm, tap **YES** .
4. The scanner creates the system with a default name. Select [Edit Name](#) if you want to change it.
5. If you need to change any of the system properties, you can do that now. Unless a property is *Required* , you can operate the system without changing the default settings.

System properties

All of these options can be found under your scanner's [Program System](#) menu. If necessary, the sub-menu and option name on each scanner are listed beside the property.

Property	Option name
Required	
Fleet map	Edit Fleet Map (Required for Motorola Type I or Type I/II Hybrid systems only)
Recommended	
Name	Edit Name
Number tag	Set Number Tag
Optional	
Automatic Gain Control (AGC)	BCD396XT and BCD996XT : Set Audio AGC BC346XT and BCT15X : Not available
Record	BCD996XT and BCT15X : Set Record BCD396XT and BC346XT : Not available
Delay time	Set Delay Time
Emergency alert	Emergency Alert
ID format	Set ID Format (DEC/HEX) or (AFS/DEC)
ID scan/search	ID Scan/Search
Priority ID scan	Priority ID scan
Status bit	Set Status bit
Available operations	
Copy a system	Copy System
Delete a system	Delete System

Review locked-out IDs	Rvw ID:Srch L/O
Clear all locked-out IDs	Clr All L/O IDs

Create at least 1 site

Each Motorola system can contain up to 256 sites, and all systems must contain at least 1 site.

1. On the [Program System](#) menu, select the system you just created.
2. Go to the [Edit Site](#) menu and select *New Site* .
3. If you need to change any of the site properties, you can do that now. Unless a property is *Required* , you can operate the system without changing the default settings.

Site properties

All of these options can be found under your scanner's [Edit Site](#) menu. If necessary, the sub-menu and option name on each scanner are listed beside the property.

Property	Option name
Required	
Band plan	Edit Band Plan
Recommended	
Name	Edit Name
Quick key	Set Quick Key
Optional	
Attenuator	Set Attenuator
Control channel only	Set C-Ch Only
Hold time	Set Hold Time
Location information	Set LocationInfo
Lockout	Set Lockout
Modulation	Set Modulation
P25 wait time	BCD396XT and BCD996XT : P25 Waiting Time
	BC346XT and BCT15X : Not available
Startup key	Set Startup Key
Available operations	
Delete a site	Delete Site

Create at least 1 frequency in each site

Each site must contain at least 1 frequency.

1. On the [Edit Site](#) menu, select the site you just created.
2. Go to the [Set Frequencies](#) sub-menu and select *New Frequency* .
3. Enter at least 1 frequency for this site.
4. If you need to change any of the frequency properties, you can do that now. Unless a property is *Required* , you can operate the system without changing the default settings.

Frequency properties

All of these options can be found by selecting the frequency under the [Set Frequencies](#) sub-menu. If necessary, the sub-menu and option name on each scanner are listed beside the property.

Property	Option name
Required	
None	
Recommended	
None	
Optional	
Lockout	Set Lockout
Available operations	
Delete a frequency	Delete Frequency

Programming a system for Scanning

Once you create the system and at least 1 site, you can scan the system in ID Search mode. In this mode, the scanner stops on all system traffic for talk groups you have not locked out. If you want to use ID Scan mode, you'll need to program channels into the system. In ID Scan, the scanner only stops on talk groups you have programmed into a channel.

Create a channel group

Each Motorola system can contain up to 20 channel groups.

1. On the [Program System](#) menu, select the system you just created.

2. Go to the [Edit Group](#) menu and select *New Group* .
3. If you need to change any of the channel group properties, you can do that now. Unless a property is *Required* , you can operate the system without changing the default settings.

Channel group properties

(All of these options can be found by selecting the group name under the [Edit Group](#) menu. If necessary, the sub-menu and the exact option name are listed beside each property.)

Required	None
Recommended	Name (Edit Name)
	Quick key (Set Quick Key)
Optional	Location information (Set LocationInfo)
	Lockout (Set Lockout)
Available operations	Delete Group

Create a channel

Each trunked system can contain up to 500 channels.

1. On the [Edit Group](#) menu, select the channel group you just created.
2. Go to the [Edit Channel](#) menu and select *New Channel* .
3. Input the Talk Group ID (TGID) for this channel.
4. If you need to change any of the channel properties, you can do that now. Unless a property is *Required* , you can operate the system without changing the default settings.

Channel properties

(All of these options can be found by selecting the channel name under the [Edit Channel](#) menu. If necessary, the sub-menu and the exact option name are listed beside each property.)

Required	TGID (Edit Talk Group ID)
Recommended	Audio type (Analog or digital) (BCD396XT and BCD996XT only) (Set Audio Type)
	Name (Edit Name)

	Number tag (Set Number Tag)
Optional	Alert (Set Alert)
	Record (BCD996XT and BCT15X: Set Record ; BCD396XT and BC346XT: Not available)
	Lockout (Set Lockout)
	Priority (Set Priority)
	Volume Offset
Available operations	Copy Channel
	Delete Channel

This page applies to the following scanner(s): [BCD996XT](#) [BCT15X](#) [BCD396XT](#) [BC346XT](#) [Users Guide](#)

Standard P25 Trunked Systems

To determine whether the information on this page applies to your scanner, see the tags at the bottom of the page.

This section deals with standard Project 25 or *P25* systems. [Click here for information on P25 one-frequency systems](#). Below is an example of a standard P25 system from [RadioReference](#):

System Name:	Austin / Travis County / Williamson County / Middle Rio Grande System										
Location:	Austin, TX										
County:	10 counties										
System Type:	Project 25 Standard										
System Voice:	APCO-25 Common Air Interface Exclusive										
Last Updated:	02-28-2008 09:44										
System Frequencies											
<small>Red* are Primary Control Channels Blue* are Secondary Control Channels</small>											
Site	Description	Freqs									
101	Simulcast 1	866.16250*	866.28750*	866.41250*	866.58250*	866.71250	866.81250	866.92500	867.08750	867.11250	
		867.31250	867.33750	867.57500	867.60000	867.82500	867.85000	868.10000	868.12500	868.36250	
		868.42500	868.62500	868.68750	868.95000						
102	Simulcast 2	866.13750*	866.31250*	866.38750*	866.58750*	866.73750	866.83750	867.16250	867.18750	867.41250	
		867.63750	867.68750	867.95000	868.05000	868.27500	868.32500	868.55000	868.57500	868.85000	
103	Marble Falls IR	866.46250	866.88750	867.28750	867.80000*	868.15000	868.75000				
104	Honeycomb IR	867.26250	867.72500*	868.17500	868.77500						
105	Burleson Manor IR	867.87500	868.22500*	868.50000	868.92500						
106	USGS Shingle IR	867.66250	867.92500*	868.40000	868.80000						

Standard P25 System

- Here is a [conceptual layout diagram](#) of a basic P25 system. ([Click here](#) for a legend of the diagram.)
- For more information on P25 systems and how they work, see the [Project 25](#) page at [Radio Reference's Wiki](#).
- [Programming a P25 System](#)
 - [Create a system](#)
 - [System properties](#)
 - [Create at least 1 site](#)
 - [Site properties](#)
 - [Create at least 1 frequency in each site](#)
 - [Frequency properties](#)
- [Programming a system for Scanning](#)
 - [Create a channel group](#)

- [Channel group properties](#)
- [Create a channel in a group](#)
 - [Channel properties](#)

Programming a P25 System

To program a P25 system, you'll need to program the required elements in following order:

Create a system

1. Go to the [Program System](#) menu and choose *New System* .
2. The scanner will prompt you for the System Type. Select *P25* .
3. The scanner will prompt you for the sub-type. Select *Standard trunk* .
4. When the scanner prompts you confirm, tap **YES** .
5. The scanner creates the system with a default name. Select [Edit Name](#) if you want to change it.
6. If you need to change any of the system properties, you can do that now. Unless a property is *Required* , you can operate the system without changing the default settings.

System properties

All of these options can be found under your scanner's [Program System](#) menu. If necessary, the sub-menu and option name on each scanner are listed beside the property.

Property	Option name
Required	
None	
Recommended	
Name	Edit Name
Number tag	Set Number Tag
Optional	
Automatic Gain Control (AGC)	Set Audio AGC
Record	Set Record (BCD996XT Only)
Delay time	Set Delay Time
ID format	Set ID Format (DEC/HEX) or (AFS/DEC)

ID scan/search	ID Scan/Search
Priority ID scan	Priority ID scan
Available operations	
Copy a system	Copy System
Delete a system	Delete System
Review locked-out IDs	Rvw ID:SrcH L/O
Clear all locked-out IDs	Clr All L/O IDs

Create at least 1 site

All systems must contain at least 1 site.

1. On the [Program System](#) menu, select the system you just created.
2. Go to the [Edit Site](#) menu and select *New Site* .
3. If you need to change any of the site properties, you can do that now. Unless a property is *Required* , you can operate the system without changing the default settings.

Site properties

All of these options can be found under your scanner's [Edit Site](#) menu. If necessary, the sub-menu and option name on each scanner are listed beside the property.

Property	Option name
Required	
None	
Recommended	
Band plan	Edit Band Plan
Name	Edit Name
Quick key	Set Quick Key
Optional	

Attenuator	Set Attenuator
Hold time	Set Hold Time
Location information	Set LocationInfo
Lockout	Set Lockout
Startup key	Set Startup Key
Available operations	
Delete a site	Delete Site

Create at least 1 frequency in each site

All sites must contain at least 1 frequency.

1. On the [Edit Site](#) menu, select the site you just created.
2. Go to the [Set Frequencies](#) sub-menu and select *New Frequency* .
3. Enter at least 1 frequency for this site.
4. If you need to change any of the frequency properties, you can do that now. Unless a property is *Required* , you can operate the system without changing the default settings.

Frequency properties

All of these options can be found by selecting the frequency under the [Set Frequencies](#) sub-menu. If necessary, the sub-menu and option name on each scanner are listed beside the property.

Property	Option Name
Required	
None	
Recommended	
None	
Optional	
Lockout	Set Lockout
Available Operations	

Delete a frequency

[Delete Frequency](#)

Programming a system for Scanning

Once you create the system and at least 1 site, you can [Search](#) the system with no problems. However, if you want to [Scan](#) the system, you'll need to program the required elements in following order ([click here for information on using the menu](#)):

Create a channel group

Each P25 system can contain up to 20 channel groups.

1. On the [Program System](#) menu, select the system you just created.
2. Go to the [Edit Group](#) menu and select *New Group* .
3. If you need to change any of the channel group properties, you can do that now. Unless a property is *Required* , you can operate the system without changing the default settings.

Channel group properties

All of these options can be found by selecting the group name under your scanner's [Edit Group](#) menu. If necessary, the sub-menu and option name on each scanner are listed beside the property.

Property	Option name
Required	
None	
Recommended	
Name	Edit Name
Quick key	Set Quick Key
Optional	
Location information	Set LocationInfo
Lockout	Set Lockout
Available operations	
Delete a group	Delete Group

Create a channel in a group

Each trunked system can contain up to 500 channels in each group.

1. On the [Edit Group](#) menu, select the channel group you just created.
2. Go to the [Edit Channel](#) menu and select *New Channel* .
3. Input the [Talk Group ID \(TGID\)](#) for this channel.
4. If you need to change any of the channel properties, you can do that now. Unless a property is *Required* , you can operate the system without changing the default settings.

Channel properties

All of these options can be found by selecting the channel name your scanner's [Edit Channel](#) menu. If necessary, the sub-menu and option name on each scanner are listed beside the property.

Property	Option name
Required	
TGID	Edit Talk Group ID
Recommended	
Name	Edit Name
Number tag	Set Number Tag
Optional	
Alert	Set Alert
Record	BCD996XT only: Set Record
Priority	Set Priority
Volume Offset	Volume Offset
Available operations	
Copy a channel	Copy Channel
Delete a channel	Delete Channel

The information on this page applies to the following scanner(s): [BCD996XT](#) [BCD396XT](#) [Users Guide](#)

Single-Frequency P25 Trunked Systems

Single-frequency P25 systems are almost identical to [standard P25 systems](#), except they only have one site per system and the system can use a P25 network address. Here is a [conceptual layout diagram](#) of a single-frequency P25 system ([click here](#) for a legend of the diagram).

- [Programming a Single-Frequency P25 System](#)
 - [Create a system](#)
 - [System properties](#)
 - [Create exactly 1 site](#)
 - [Site properties](#)
- [Programming a system for Scanning](#)
 - [Create a channel group](#)
 - [Channel group properties](#)
 - [Create a channel](#)
 - [Channel properties](#)

Programming a Single-Frequency P25 System

To program a single-frequency P25 system, you'll need to program the required elements in following order ([click here for information on using the menu](#)):

Create a system

1. Go to the [Program System](#) menu and choose *New System* .
2. The scanner will prompt you for the System Type. Select *P25* .
3. When the scanner prompts you to select *Standard Trunk* or *One-Freq Trunk* select *One-Freq Trunk*, then tap **YES** .
4. The scanner creates the system with a default name. Select [Edit Name](#) if you want to change it.
5. If you need to change any of the system properties, you can do that now. Unless a property is *Required* , you can operate the system without changing the default settings.

System properties

(All of these options can be found under the [Program System](#) menu. If necessary, the sub-menu and the exact option name are listed beside each property.)

Required	None
Recommended	Name (Edit Name)
	Network address (P25 NAC Option)
	Number tag (Set Number Tag)
Optional	Automatic gain control (AGC) (Set Audio AGC)
	Record (BCD996XT and BCT15X only Set Record)
	Delay time (Set Delay Time)
	ID format (Set ID Format (DEC/HEX) or (AFS/DEC))
	ID scan/search (ID Scan/Search)
Available Operations	Copy system
	Delete system
	Review Locked-Out IDs (Rvw ID:Srch L/O)
	Clear All Locked-Out IDs (Clr All L/O IDs)

Create exactly 1 site

Each single-frequency P25 system must contain exactly 1 site.

1. On the [Program System](#) menu, select the system you just created.
2. Go to the [Edit Site](#) menu and select *New Site* .
3. Select the [Set Frequencies](#) menu and enter the frequencies for this site.
4. If you need to change any of the site properties, you can do that now. Unless a property is *Required* , you can operate the system without changing the default

settings.

Site properties

(All of these options can be found by selecting the site name under the [Edit Site](#) menu. If necessary, the sub-menu and the exact option name are listed beside each property.)

Required	Frequencies (Set Frequencies)
Recommended	Name (Edit Name)
	Quick key (Set Quick Key)
Optional	Attenuator (Set Attenuator)
	Hold time (Set Hold Time)
	Location information (Set LocationInfo)
	Lockout (Set Lockout)
	Startup key (Set Startup Key)
Available Operations	Delete Site

Programming a system for Scanning

Once you create the system and site, you can [Search](#) the system with no problems. However, if you want to [Scan](#) the system, you'll need to program the required elements in following order ([click here for information on using the menu](#)):

Create a channel group

Each P25 system can contain up to 20 channel groups.

1. On the [Program System](#) menu, select the system you just created.

2. Go to the [Edit Group](#) menu and select *New Group* .
3. If you need to change any of the channel group properties, you can do that now. Unless a property is *Required* , you can operate the system without changing the default settings.

Channel group properties

(All of these options can be found by selecting the group name under the [Edit Group](#) menu. If necessary, the sub-menu and the exact option name are listed beside each property.)

Required	None
Recommended	Name (Edit Name)
	Quick key (Set Quick Key)
Optional	Location information (Set LocationInfo)
	Lockout (Set Lockout)
Available operations	Delete Group

Create a channel

Each trunked system can contain up to 500 channels in each group.

1. On the [Edit Group](#) menu, select the channel group you just created.
2. Go to the [Edit Channel](#) menu and select *New Channel* .
3. Input the [Talk Group ID \(TGID\)](#) for this channel.
4. If you need to change any of the channel properties, you can do that now. Unless a property is *Required* , you can operate the system without changing the default settings.

Channel properties

(All of these options can be found by selecting the channel name under the [Edit Channel](#)

menu. If necessary, the sub-menu and the exact option name are listed beside each property.)

Required	TGID (Edit Talk Group ID)
Recommended	Name (Edit Name)
	Number tag (Set Number Tag)
Optional	Alert (Set Alert)
	Record (BCD996XT and BCT15X only Set Record)
	Lockout (Set Lockout)
	Volume Offset
Available operations	Copy Channel
	Delete Channel

This page applies to the following scanner(s): [BCD996XT](#) [BCD396XT](#) [Users Guide](#)

Radio Systems Overview

There are two basic types of radio systems: conventional systems and trunked systems.

- [Conventional radio systems](#)
- [Trunked radio systems](#)
 - [Trunked system basics](#)
 - [How a trunked system works](#)
 - [A real life example](#)

Conventional radio systems

In a conventional radio system, each group of users is assigned one (for simplex systems) or two frequencies (for repeater systems). For example, the police in your area might operate on 460.500 MHz, the fire department on 154.445 MHz, the highway department on 37.900 MHz, etc. All transmissions from each group always go out on the on the same frequency--the police won't randomly switch to 500.000 MHz, for instance.

Since each group always stays on the same frequency and frequencies never overlap, it's very easy to follow conversations on conventional systems: when your scanner stops on a frequency, you usually know who it is, and more importantly, you can stop on a channel and listen to an entire conversation.

Up until the late 1980s, this was the primary way that radio systems operated. Some examples of conventional radio systems are

- Aircraft
- Amateur radio
- FRS/GMRS users
- Small, private radio systems

Trunked radio systems

Several major trends have converged that have resulted in agencies moving to more efficient *trunked* radio systems:

- Higher levels of radio usage has meant that there aren't enough individual frequencies available to allow every group to have their own frequency.
- Technology advances have brought down the overall cost and complexity of implementing a trunked radio system while increasing the features available to the agency and individual radio users.
- Roll-out of major statewide trunked systems makes it easier for even small agencies to piggy back onto the larger system for less cost than replacing existing systems.

Trunked system basics

There are three major elements common to most trunked systems:

System Controller

The system controller is a special computer that assigns voice channels to users as they key up their radio. The controller is the brains behind the trunking system.

Voice Frequency Pool

The voice frequency pool is a selection of radio frequencies available to the system controller for assigning voice traffic. By assigning voice frequencies to channels only as they are needed, a trunked system can support many more channels than it actually has frequencies.

Talk Group IDs

A Talk Group ID identifies which user or agency has been assigned a particular voice frequency at any particular moment. The Talk Group ID is essentially the user's "channel": since each voice frequency is used over and over by all the agencies on the system, trunked systems rely on the Talk Group ID to identify which particular user or agency is talking.

How a trunked system works

A typical communication on a trunked system goes something like this:

1. A user selects the channel they want to communicate on and presses the PTT button on the side of their radio.
2. This sends a channel request message to the controller that the user wants to start a transmission on the Talk Group ID (the channel) that they selected.
3. The controller locates an unused voice frequency and assigns it to that Talk Group ID.
4. The controller then sends out a *channel grant message* to all radios on the system so everyone knows where to find the voice channel for that Talk Group.
5. At this point, the original user's radio beeps, and the user can begin their transmission. While this sounds complicated, in real life this process takes about half a second (sometimes less).

When the user releases the PTT button, the controller releases the voice frequency from its Talk Group ID assignment, leaving the frequency free for the next user that becomes active.

A real life example

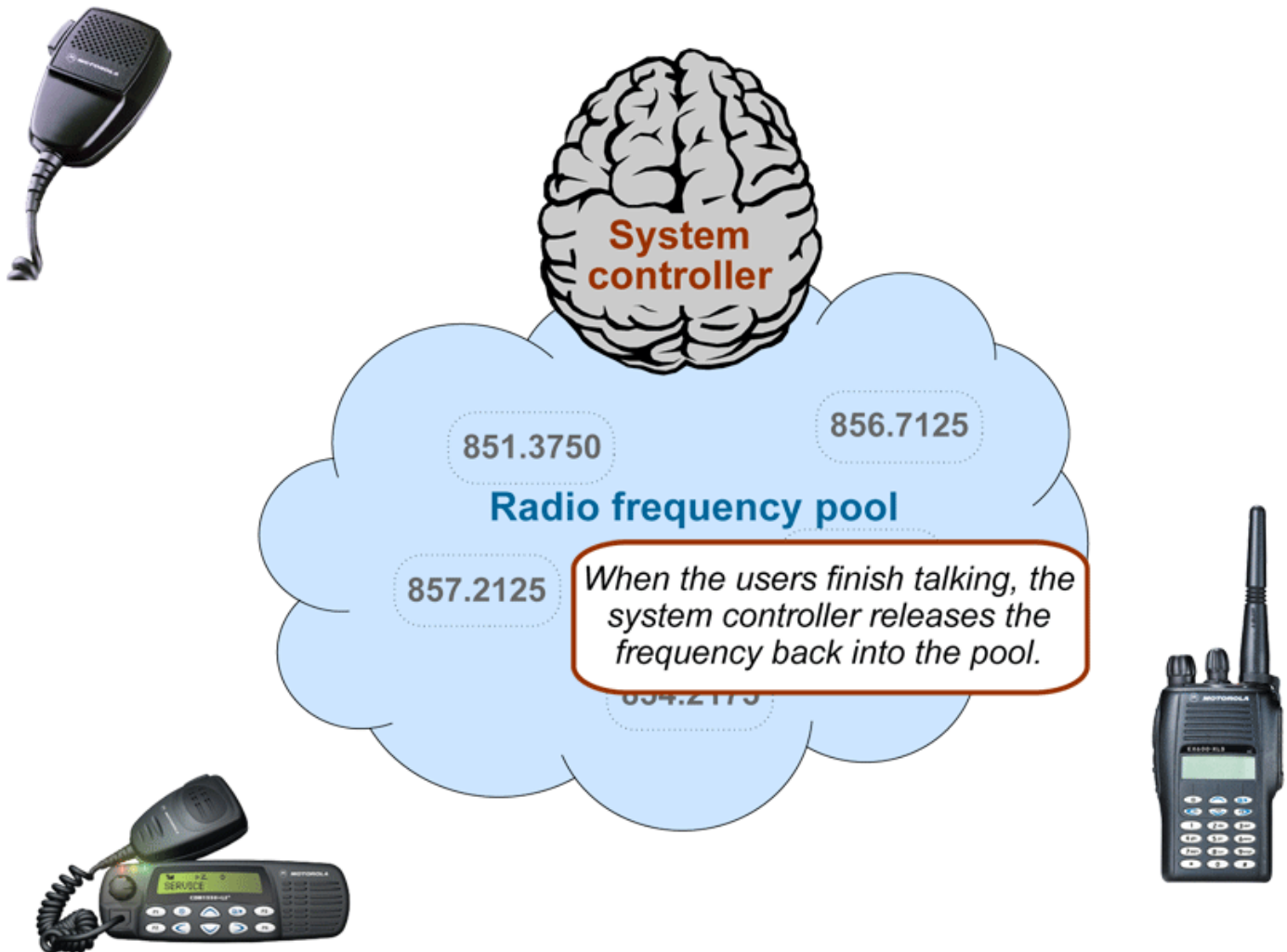

A typical 20-frequency trunked system can support hundreds of channels. For example, the Fort Worth system includes over 400 channels providing communication support for Fort Worth agencies (Police, Fire and Ambulance) and agencies in the surrounding cities of Kennedale, North Richland Hills, Forest Hill, Haltom City and Richland Hills. In addition, the same system also supports the Tarrant County Sheriff and Texas Christian University. (You can see its setup in the [RadioReference database](#).)

Before moving to the trunked system, the Police had only 6 channels (North, South, East, West, Information, and Tactical). Since moving to the trunked system, they are now able to provide 11 channels for North Side PD alone: a main dispatch channel, three talkaround channels, a supervisor channel, a bike patrol channel, and several community patrol channels. Other police districts have similar channel requirements, and now special

operations teams such as SWAT, Narcotics, and Traffic each have one or more dedicated channels for their use as well.

This page applies to the following scanner(s): [BCD996XT](#) [BCT15X](#) [BCD396XT](#) [BC346XT](#) [Users Guide](#)

Deciphering Trunked Systems

- [Before you program a trunked system](#)
 - [System Type](#)
 - [P25 Systems](#)
 - [LTR Systems](#)
 - [Motorola Systems](#)
 - [EDACS Systems](#)
 - [Conventional Systems](#)
 - [Non-scannable Systems](#)
 - [System Voice](#)
 - [System Frequencies](#)
 - [Talk Group IDs \(Channels\)](#)

Before you program a trunked system

To the average radio user, the complexity of a trunked system is invisible. Their radio is programmed up at the radio shop. They can still easily select who they need to communicate with by selecting a channel on their two-way. They can even directly call other radio users without tying up a dispatch channel something they could never do before. As a scanner user, on the other hand, you need to know the different types of trunking systems in use, what options are available on each system, and three key pieces of information about any trunking system before you start any actual programming:

- System Type
- System Frequencies
- IDs of the Talk Groups you want to hear

All of this information is usually available from the online database at [RadioReference](#). The picture to the right shows a screenshot of a system from the database, with the pertinent information highlighted.

System Name: Fort Worth / Tarrant County Public Safety
Location: Fort Worth, TX
County: Tarrant
System Type: Motorola Type II Smartnet
System Voice: Analog
Last Updated: Updated on 01/11/2009 12:00:00 AM for J. Walker
Hits: 25843

System ID List

System ID	Connect Tone
3632	90.00

System Frequencies

Red (c) are Primary Control Channels | Blue (a) are alternate control channels | Click a Site Name for additional site information | Site Map: [ECC Callsigns](#) [RR Locations](#)

Site Name	Freqs
001 Primary	866.16250 866.21250 866.28750 866.36250 866.38750 866.66250 866.68750 866.71250 866.83750 866.88750 867.16250 867.21250 867.26250 867.33750 867.38750 867.66250 867.71250c 867.76250c 867.83750c 867.88750c

System Talkgroups

Updated in the last 7 days Updated in the last 24 hours [List All](#) in one table [Show New](#) Talkgroups

FWPD North Talkgroups

DEC	HEX	Mode	Alpha Tag	Description	Tag
2992	0bb	A	N-PTL	NORTH DIVISION - PATROL	Law Dispatch
3024	0bd	A	N-CID	NORTH DIVISION - CID	Law Tac
3056	0bf	A	N-COPS	NORTH DIVISION - CRO/CODE BLUE	Law Tac
3088	0c1	A	N-SUPV	NORTH DIVISION - SUPERVISOR	Law Tac
3120	0c3	A	N-FOOT	NORTH DIVISION - FOOT/BIKE PATROL	Law Tac
3152	0c5	A	N-TLK1	NORTH DIVISION - TALK CH 1	Law Talk
3184	0c7	A	N-TLK2	NORTH DIVISION - TALK CH 2	Law Talk
3216	0c9	A	N-TLK3	NORTH DIVISION - TALK CH 3	Law Talk
6864	1ad	A	N-COPS2	NORTH DIVISION - CRO/CODE BLUE	Law Tac
18832	499	A	N-COPS3	NORTH DIVISION - CRO/CODE BLUE	Law Tac
18864	49b	A	N-COPS4	NORTH DIVISION - CRO/CODE BLUE	Law Tac

FWPD South Talkgroups

DEC	HEX	Mode	Alpha Tag	Description	Tag
2448	099	A	S-PTL	SOUTH DIVISION - PATROL	Law Dispatch
2480	09b	A	S-CID	SOUTH DIVISION - CID	Law Tac
2512	09d	A	S-COPS	SOUTH DIVISION - CRO/CODE BLUE	Law Tac

System type

System voice (Types of voice modulation used on the system.)

System frequencies (Red or blue text means the frequency is a control channel.)

Talk group information (There may be several screens of data in larger systems.)

System Type

There are five major types of scannable systems; some of these also have subtypes. In the RadioReference database, you can generally determine the radio system type by looking at the line labeled *System Type* at the top of the screen (inside the red square in the screenshot).

P25 Systems

These are identified in the RadioReference database as *Project 25 Standard* . If the System Type line says anything else, then it is not a P25 system (even though it might have some P25 channels).

LTR Systems

These systems are identified as *LTR Standard* in the system type.

Motorola Systems

There are several subcategories of Motorola systems, but they will all have some form of *Motorola* in the system type: *Motorola Fleetnet* , *Motorola Smartnet* , *Motorola Smartzone* , etc. Once you have identified that it is a Motorola system, you can check the system frequencies to confirm its subtype:

- Motorola 800: all of the frequencies are in the 800 MHz range
- Motorola 900: all of the frequencies are in the 900 MHz range
- Motorola UHF: all of the frequencies are between 400 and 512 MHz
- Motorola VHF: all of the frequencies are between 100 and 200 MHz.

EDACS Systems

There are three subtypes of EDACS systems:

- EDACS Wide: identified as *EDACS Standard* in the system type.
- EDACS Narrow: identified as *EDACS Narrowband* in the system type.
- EDACS SCAT: identified as *EDACS Scat* in the system type (these systems operate on a single frequency).

Conventional Systems

This fifth type of scannable system is a general catchall for all non-trunked systems. See [Conventional Systems](#) for more information.

Non-scannable Systems

There are several system types that cannot be monitored with a scanner, either because the systems use proprietary digital formats that are not licensable by scanner manufacturers, or because the systems are not in wide enough use to make it cost-effective for manufacturers to

develop a scanner that can monitor them.

These non-scannable systems are identified in the system type as:

- EDACS w/ESK
- LTR Passport
- OpenSky Standard
- MPT1327
- Tetra

System Voice

The other line inside the red square in the screenshot is *System Voice* , which summarizes the kinds of voice modulation used on the system. You'll find the following voice types:

- Analog (can be heard with any trunking scanner)
- APCO-25 (can be heard with a digital scanner)
- ProVoice (cannot be heard by any scanner)
- VSELP (cannot be heard by any scanner)

System Name:	Mansfield Public Safety
Location:	Mansfield, TX
County:	Tarrant
System Type:	Motorola Type II SmartZone
System Voice:	Analog and APCO-25 Common Air Interface
Uniden DSP:	983 1985 2892
Last Updated:	<i>Tagged 21 Talkgroups with (Law Dispatch)</i>
Hits:	5225

The system voice also tells us when digital channels are mixed in with analog channels on the same system. Unfortunately, this means the system voice line can cause a lot of confusion. Just remember: system *voice* does not define the system *type* .

For example, in the system information shown to the left, we see that *APCO-25* can be used as a voice type on a Motorola system that is not actually a *P25 system* . When we're trying to determine whether a system is a P25 system, we need to ignore the *System Voice* line and focus on the *System Type* line. If there is P25 Voice on a non-P25 system, the scanner can sort this out while scanning.

System Frequencies

The *system frequencies* section in the database lists all the frequencies used by the system (see the blue square in the screenshot above on the right). For Motorola and P25 systems, you will

need to program only the system control channel frequencies: those are the frequencies shown in red (for primary control channels) and blue (for alternate control channels) in the database.

For EDACS and LTR systems, you will need to program all the listed frequencies and their associated LCN (that is a small number right next to the frequency). Some systems have multiple sets of frequencies. These are called *multi-site* systems: each set of frequencies corresponds to a different physical antenna site.

Talk Group IDs (Channels)

The Talk Group information section (inside the green rectangle) shows the different channels on the system and which agency uses them. You'll need to go through the list and make a note of the channels you want to hear. Then you can start thinking about how you want to organize those channels.

(Keep in mind that this screenshot shows just a few of the channels on a single system. One of the great features available to subscribers on RadioReference is the ability to tag channels directly on the site and print out a nicely-formatted hardcopy of each system. It makes this task much, much easier.)

This page applies to the following scanner(s): [BCD996XT](#) [BCT15X](#) [BCD396XT](#) [BC346XT](#)
[Users Guide](#)

Location-based Scanning

Location-based scanning allows you to control which systems/sites and channel groups are scanned based on your exact location. This frees you from having to manually enable and disable systems or channel groups as you change location.

To use Location-Based scanning, you need to have the following:

- the location for the center point for each system/site or channel group you want to control
- the radius or distance from the center point you want to set as the range for each system/site or channel group
- if you are scanning while traveling, you may want to include the heading (direction) of travel
- some type of mapping method. If you don't want to use paper maps, you might try a mapping software (such as Microsoft® Streets and Trips or Delorme® Street Atlas) that allows you to draw markings and overlays on maps.
- a GPS receiver with a serial data output (NMEA)

There are many different approaches you can use to determine where to place a center point for a system/site or channel group. The two most common are the geopolitical approach and the antenna-centric approach. For large trunked systems, you may find that a combination of these two approaches works best.

- [The Geopolitical Approach](#)
- [The Antenna-Centric Approach](#)
 - [Finding an antenna location](#)
- [Combining for Efficiency](#)
- [See Also](#)

The Geopolitical Approach

With the geopolitical approach, you want the scanner to turn on the system/site or channel group at the limit of relevance rather than reception. This approach is useful for scanning

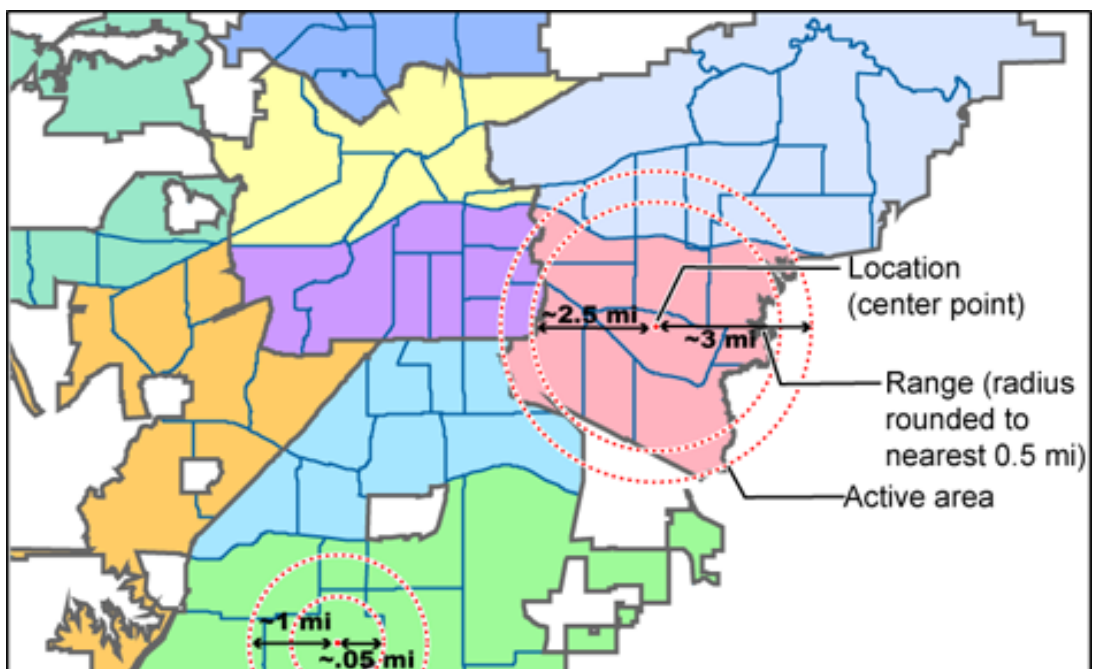

targets that have a well-defined jurisdiction and their transmission are only relevant when you are within that jurisdiction.

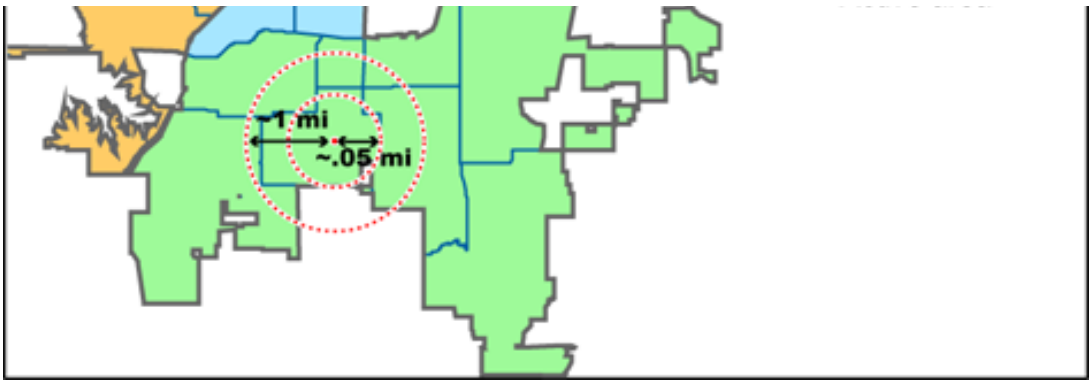

To use the geopolitical approach, find the geographical center of the scanning target's territory (whether city, county, district, precinct, or other agency jurisdiction), and set these coordinates as your center point location. Then, adjust the range or radius to cover the boundaries of that target.

To use this method, use your chosen mapping application to zoom out so that the entire target is visible, then, draw a circle that just covers the target's boundaries. Adjust the size of the circle to the nearest 1/2 mile increment.

Depending on the shape of the territory, you may have to choose between a lot of overlap or not covering the entire area: jurisdiction, you might end up with a large amount of overlap. You'll have to decide which radius that best suits your application.

For example, if your territory is a city, you'll have a lot of "extra" area if you use one single location:

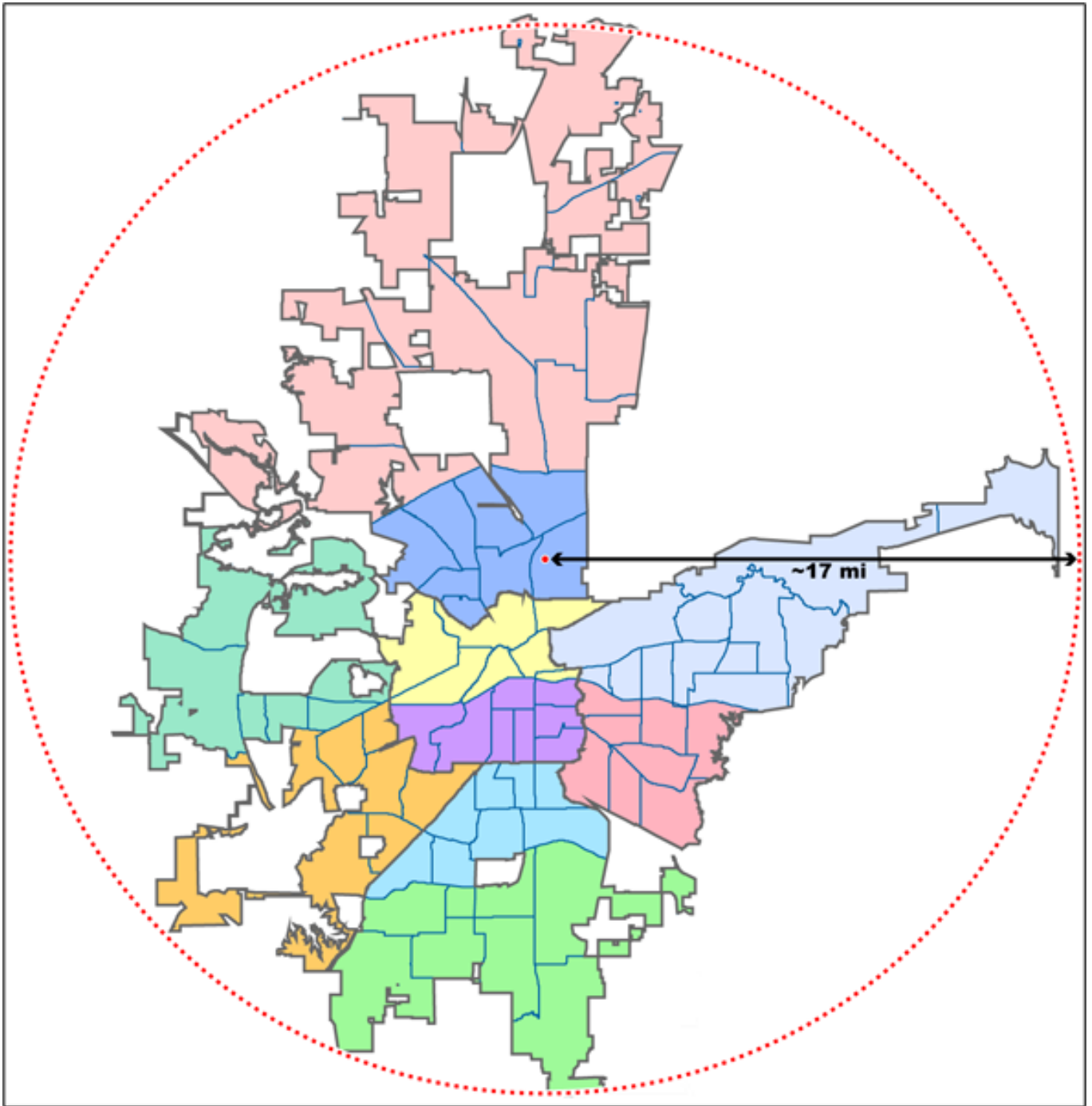

On the other hand, if you sub-divide the area, you may end up with areas that are not covered:

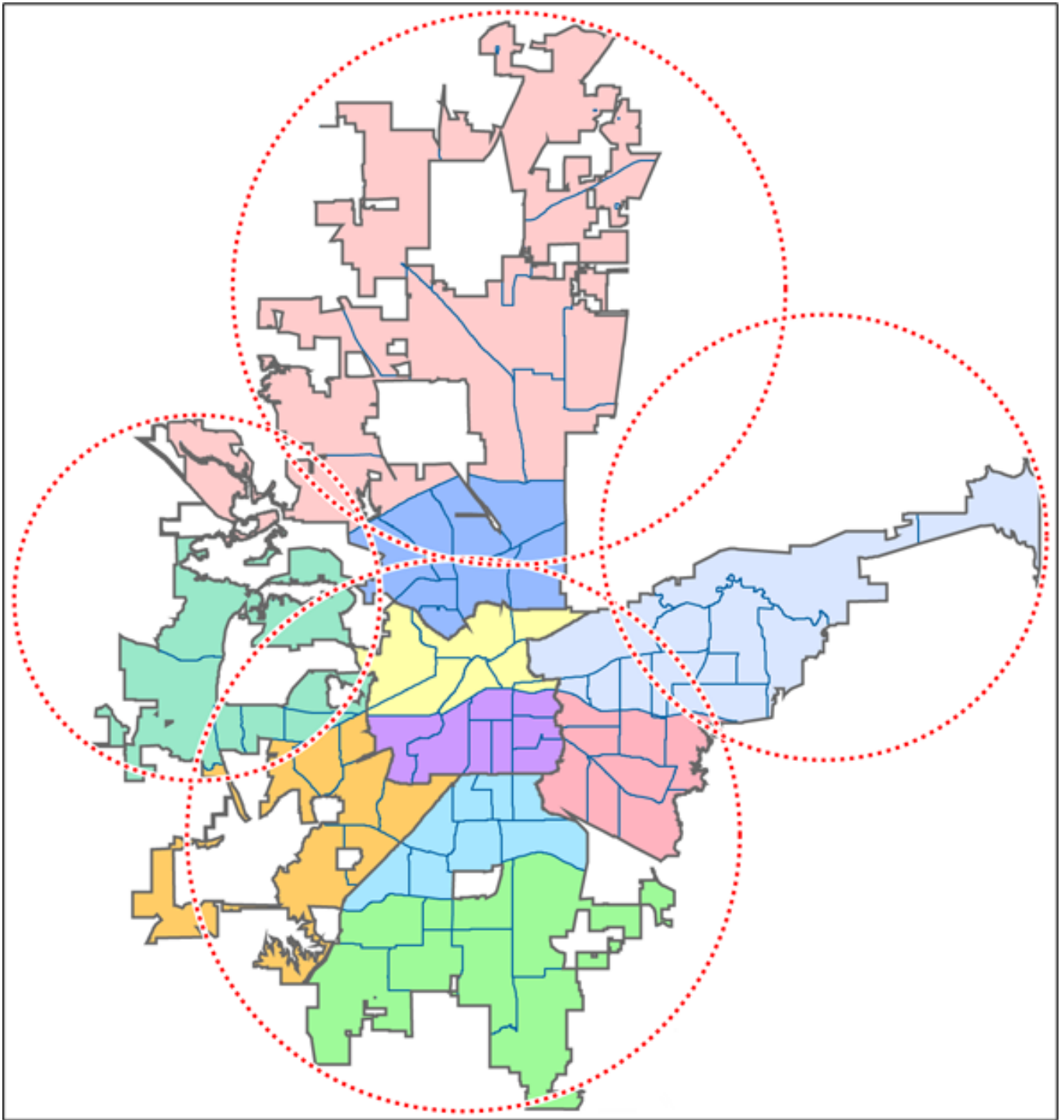

The Antenna-Centric Approach

Using an antenna-centric approach, you set the physical antenna location as the system/sites center point and the antenna's actual reach as the range.

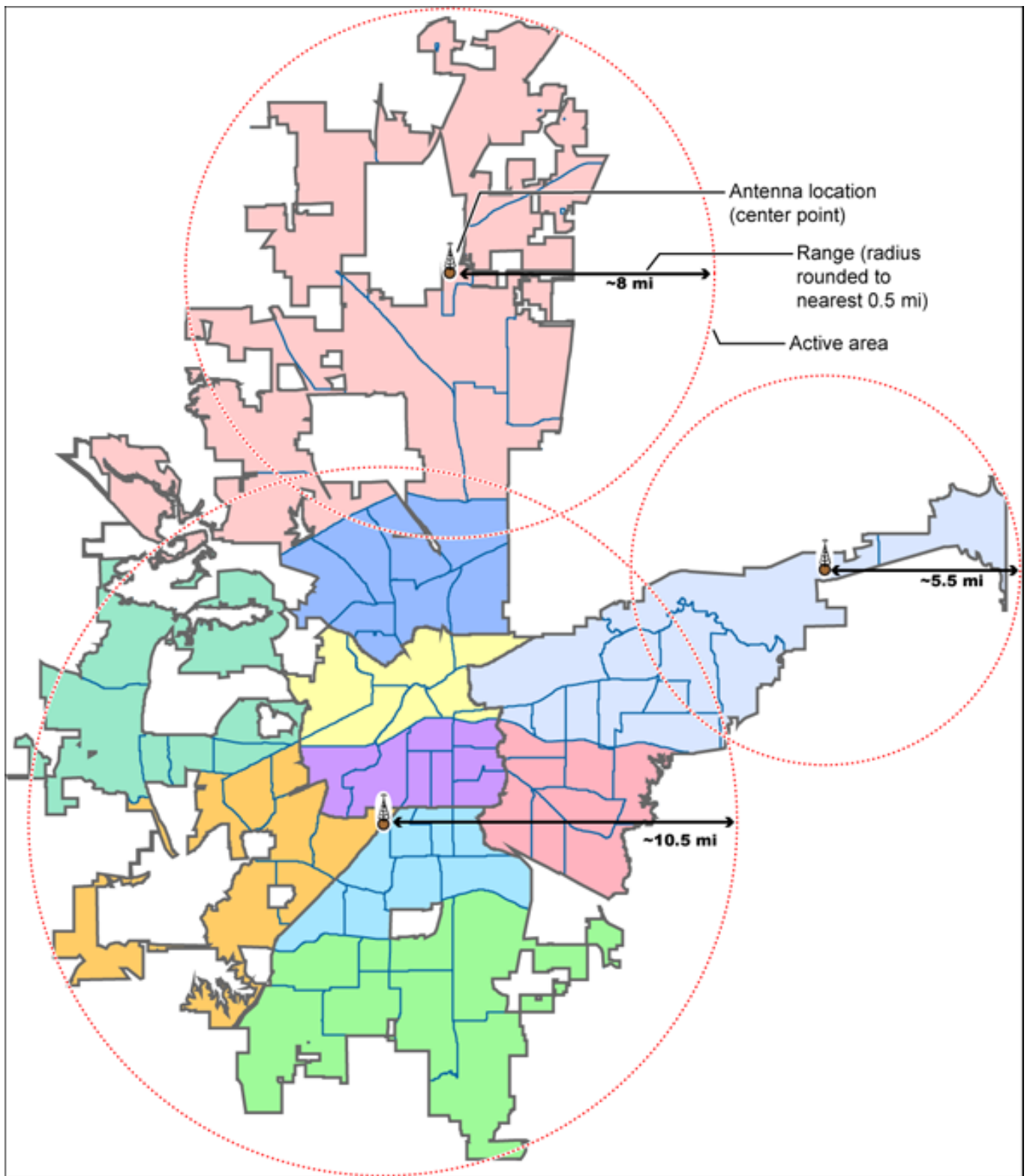

Finding an antenna location

You can find the physical location of antennas using the databases available at [Radio Reference](#) or the FCC's Antenna Structure Registration site. Both sites list the latitude, longitude, and height of the antenna, and both sites can map the exact location for you. ([Radio Reference](#) is more user-friendly, so it's easier to

find what you're looking for.)

Combining for Efficiency

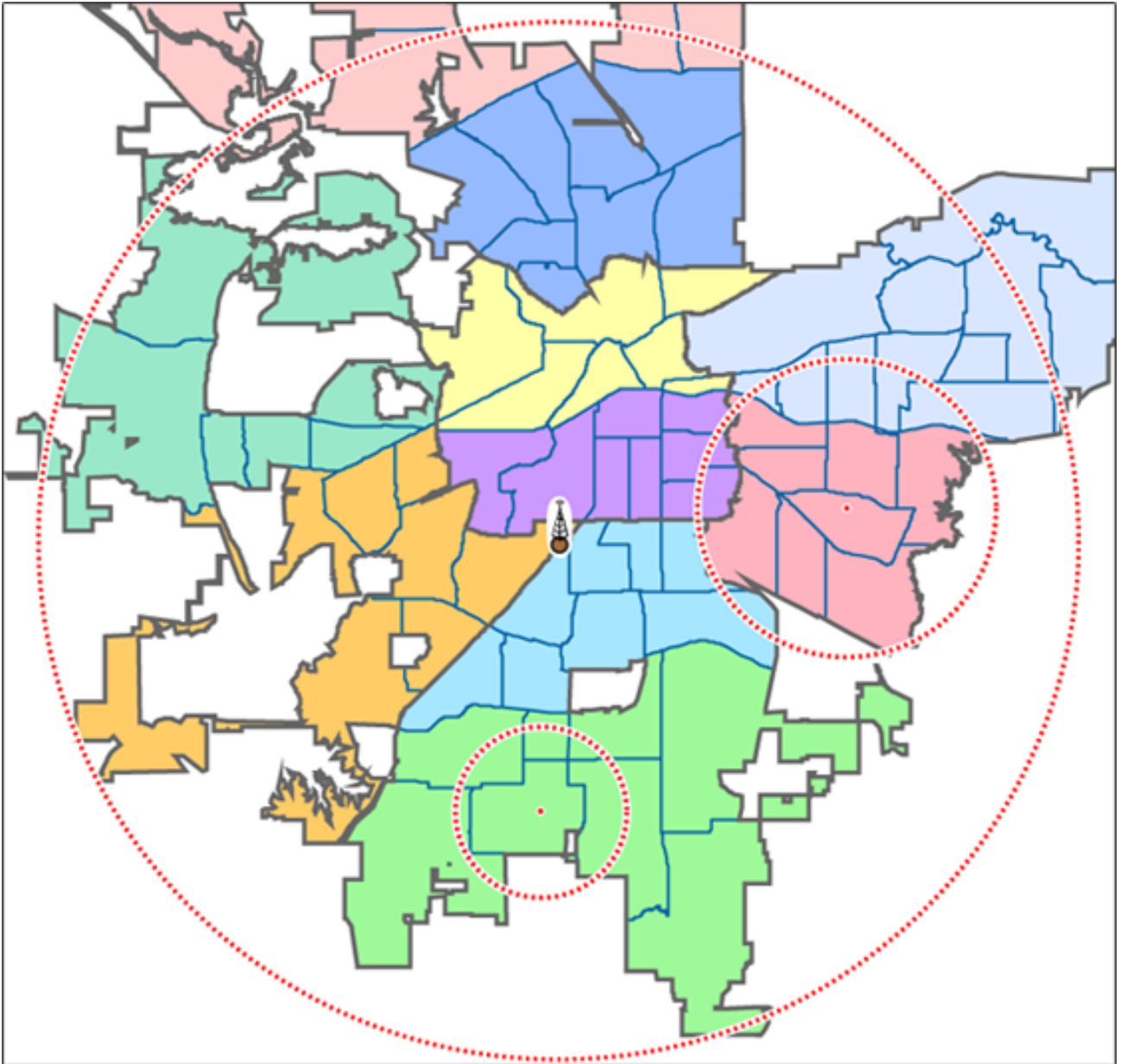

Because many trunked systems have both multiple antenna sites and multiple agencies with differing geographic boundaries, you may want to combine the approaches:

1. Use the antenna centric approach at the site level: set the geographic coordinates of the antenna as the central location for each site.
2. Use the geopolitical approach at the channel group level. Within the same system, set up a channel group for each agency, and set the central point of the agency territory as the group location.

With both approaches combined into a single system, the scanner will now seamlessly switch between

antenna sites as needed to keep the scanner tuning only to those sites you can receive well, and will also turn channel groups on and off as you relocate to different jurisdictions.

See Also

[Connecting a GPS receiver](#)

[Programming locations](#)

This page applies to the following scanner(s): [BCD996XT](#) [BCT15X](#) [BCD396XT](#) [BC346XT](#) [Users Guide](#)

Scanning Legally

Your scanner covers frequencies used by many different groups, including police and fire departments, ambulance services, government agencies, private companies, amateur radio services, military operations, pager services, and wireline (telephone and telegraph) service providers.

It is legal to listen to almost every transmission your scanner can receive. However, there are some transmissions that you should never intentionally listen to. These include:

- Telephone conversations (cellular, cordless, or other private means of telephone signal transmission)
- Pager transmissions
- Any scrambled or encrypted transmissions

According to the Electronic Communications Privacy Act (ECPA), you are subject to fines and possible imprisonment for intentionally listening to, using, or divulging the contents of such a conversation unless you have the consent of a party to the conversation (unless such activity is otherwise illegal).

This scanner has been designed to prevent the reception of cellular telephone transmissions and the decoding of scrambled transmissions. This is done to comply with the legal requirement that scanners be manufactured so they are not easy to modify to pick up these transmissions. Do not open your scanner's case to make any modifications that could allow it to pick up transmissions that are illegal to monitor. Modifying or tampering with your scanner's internal components or using it in a way other than as described in the manual could invalidate your warranty and void your FCC authorization to operate it.

In some areas, mobile and/or portable use of this scanner is unlawful or requires a permit. Check the laws in your area. It is also illegal in many areas (and a bad idea everywhere) to interfere with the duties of public safety officials by traveling to the scene of an incident without authorization.

Digital Scanners Only: A license is required to use this product in Canada!

This page applies to the following scanner(s): [BCD996XT](#) [BCT15X](#) [BCD396XT](#)
[BC346XT Users Guide](#)

General Precautions

Before you use this scanner, please read and observe the following:

Earphone Warning

You can use an optional 32Ω stereo headset or earphone with your scanner. Use of an incorrect earphone or headset might be potentially hazardous to your hearing. The output of the phone jack is monaural, but you will hear it in both headphones of a stereo headset.

Set the volume to a comfortable audio level coming from the speaker before plugging in the earphone or headset. Otherwise, you might experience some discomfort or possible hearing damage if the volume suddenly becomes too loud because of the volume control or squelch control setting. This might be particularly true of the type of earphone that is placed in the ear canal.

Liquid Exposure Warning

Uniden does not represent this unit to be waterproof. To reduce the risk of fire or electrical shock, do not expose this unit to rain or moisture!

Power Disconnection Caution

Important: Always turn the scanner off before disconnecting external power. Some settings are saved only as the scanner is powering down.

This topic applies to the following scanner(s): [BCD996XT](#) [BCT15X](#) [BCD396XT](#)
[BC346XT](#) [Users Guide](#)

FCC Information

The FCC Wants You to Know

IMPORTANT! This scanning radio has been manufactured so that it will not tune to the radio frequencies assigned by the FCC for cellular telephone usage. The Electronic Communications Privacy Act of 1986, as amended, makes it a federal crime to intentionally intercept cellular or cordless telephone transmissions or to market this radio when altered to receive them. The installation, possession, or use of this scanning radio in a motor vehicle may be prohibited, regulated, or require a permit in certain states, cities, and/or local jurisdictions. Your local law enforcement officials should be able to provide you with information regarding the laws in your community.

For more details, see [Scanning Legally](#).

Modification Notice

Changes or modifications to this product not expressly approved by Uniden, or operation of this product in any way other than as detailed by this User's Guide, could void your authority to operate this product.

Part 15 Information

This scanner has been tested and found to comply with the limits for a scanning receiver, pursuant to Part 15 of the FCC Rules. These limits are designed to provide reasonable protection against harmful interference in a residential installation. This scanner generates, uses, and can radiate radio frequency energy and, if not installed and used in accordance with the instructions, may cause harmful interference to radio communications.

There is no guarantee that interference will not occur in a particular installation. If this scanner does cause harmful interference to radio or television reception, which can be determined by turning the scanner on and off, you are encouraged to try to correct the interference by one or more of the following measures:

- Reorient or relocate the receiving antenna.

- Increase the separation between the scanner and the receiver

This device complies with Part 15 of the FCC Rules. Operation is subject to the following two conditions:

1. This device may not cause harmful interference, and
2. this device must accept any interference received, including interference that may cause undesired operation.

This page applies to the following scanner(s): [BCD996XT](#) [BCT15X](#) [BCD396XT](#)
[BC346XT](#) [Users Guide](#)

Warranty and Support Information

Support Information

Information online	www.uniden.com
Email support	http://mycusthelp.com/uniden
Phone support	(800) 297-1023 (during regular business hours, Central time)

One-Year Limited Warranty

This warranty text applies to the following scanners:

- [BCD396XT](#)
- [BC346XT](#)
- [BCD996XT](#)
- [BCT15X](#)

If your scanner is not listed, the warranty information below may not apply.

Important: Evidence of original purchase is required for warranty service!

WARRANTOR: UNIDEN AMERICA CORPORATION (Uniden)

ELEMENTS OF WARRANTY: Uniden warrants, for one year, to the original retail owner, this Uniden Product to be free from defects in materials and craftsmanship with only the limitations or exclusions set out below.

WARRANTY DURATION: This warranty to the original user shall terminate and be of no further effect 12 months after the date of original retail sale. The warranty is invalid if

the Product is

- (A) damaged or not maintained as reasonable or necessary,
- (B) modified, altered, or used as part of any conversion kits, subassemblies, or any configurations not sold by Uniden,
- (C) improperly installed,
- (D) serviced or repaired by someone other than an authorized Uniden service center for a defect or malfunction covered by this warranty,
- (E) used in any conjunction with equipment or parts or as part of any system not manufactured by Uniden, or
- (F) installed or programmed by anyone other than as detailed by the Operating Guide for this product.

STATEMENT OF REMEDY: In the event that the product does not conform to this warranty at any time while this warranty is in effect, warrantor will repair the defect and return it to you without charge for parts, service, or any other cost (except shipping and handling) incurred by warrantor or its representatives in connection with the performance of this warranty. **THE LIMITED WARRANTY SET FORTH ABOVE IS THE SOLE AND ENTIRE WARRANTY PERTAINING TO THE PRODUCT AND IS IN LIEU OF AND EXCLUDES ALL OTHER WARRANTIES OF ANY NATURE WHATSOEVER, WHETHER EXPRESS, IMPLIED OR ARISING BY OPERATION OF LAW, INCLUDING, BUT NOT LIMITED TO ANY IMPLIED WARRANTIES OF MERCHANTABILITY OR FITNESS FOR A PARTICULAR PURPOSE. THIS WARRANTY DOES NOT COVER OR PROVIDE FOR THE REIMBURSEMENT OR PAYMENT OF INCIDENTAL OR CONSEQUENTIAL DAMAGES.** Some states do not allow this exclusion or limitation of incidental or consequential damages so the above limitation or exclusion might not apply to you.

LEGAL REMEDIES: This warranty gives you specific legal rights, and you might also have other rights which vary from state to state. This warranty is void outside the United States of America.

PROCEDURE FOR OBTAINING PERFORMANCE OF WARRANTY: If, after following the instructions in this Operating Guide you are certain that the Product is defective, pack the Product carefully (preferably in its original packaging). Include evidence of original purchase and a note describing the defect that has caused you to return it. The Product should be shipped freight prepaid, by traceable means, or delivered, to warrantor at:

Uniden America Corporation Parts and Service Division 4700 Amon

Carter Boulevard Fort Worth, TX 76155

This page applies to the following scanner(s): [BCD996XT](#) [BCT15X](#) [BCD396XT](#)
[BCD346XT Users Guide](#)

User Guide Information

Illustrations in this guide are used for explanation purposes only. Your scanner may not match the illustrations exactly.

All content (including any media) contained within in this guide is copyright 2009 by Uniden America Corporation unless otherwise specified. Any content not belonging to Uniden America is marked as such and used with permission.

Content or information in external sources are neither the intellectual property not the responsibility of Uniden America Corp. Uniden America makes no claim to the accuracy or completeness of external content.

Screen grabs used in most examples are provided with the permission of RadioReference.com

Astro®, DPL®, Digital Private Line®, Motorola®, PL®, PRIVACY PLUS®, Private Line®, SMARTNET®, and SMARTZONE® are registered trademarks of Motorola, Inc.

LTR® is a registered trademark of E.F. Johnson Co.

EDACS® is a registered trademark of M/A-COM Private Radio Systems Inc.

Uniden® and Bearcat® are registered trademarks of Uniden America Corporation.

TrunkTracker™, Trunk Tracking™, and Close Call™ are proprietary trademarks of Uniden America Corporation.

Other trademarks used throughout this manual are the property of their respective holders.

[Users Guide](#)



Results from UnidenManBeta web retrieved at 20:07 (GMT)

[AvailableOperationModes](#)

[PaulOpitz](#)

r14 - [15 Apr 2009 - 15:00](#)

[BCD996XT](#)

[PaulOpitz](#)

r11 - [16 Apr 2009 - 20:04](#)

[BCD996XTBandScopeMode](#)

[PaulOpitz](#)

r4 - [15 Apr 2009 - 16:00](#)

[BCD996XTCloseCallMode](#)

[PaulOpitz](#)

r6 - [13 Apr 2009 - 16:26](#)

[BCD996XTGPSMode](#)

[PaulOpitz](#)

r6 - [13 Apr 2009 - 16:34](#)

[BCD996XTHoldMode](#)

[PaulOpitz](#)

r4 - [13 Apr 2009 - 18:52](#)

[BCD996XTKeySafeMode](#)

[PaulOpitz](#)

r5 - [13 Apr 2009 - 18:58](#)

[BCD996XTKeysAndTheirFunctions](#)

[PaulOpitz](#)

r3 - [31 Mar 2009 - 20:33](#)

BCD996XTMenuTree

[PaulOpitz](#)

r5 - [13 Apr 2009 - 18:59](#)

BCD996XTScanMode

[PaulOpitz](#)

r7 - [13 Apr 2009 - 19:06](#)

BCD996XTSettings

[PaulOpitz](#)

r5 - [13 Apr 2009 - 19:07](#)

BCD996XTSpecs

[PaulOpitz](#)

r9 - [16 Apr 2009 - 19:12](#)

BCD996XTToneOutMode

[PaulOpitz](#)

r3 - [13 Apr 2009 - 19:31](#)

CalculatingUpperBaseFrequencies

[PaulOpitz](#)

r5 - [24 Mar 2009 - 18:31](#)

CategoryBCD996XT

[PaulOpitz](#)

r2 - [24 Mar 2009 - 18:35](#)

CloseCall

[PaulOpitz](#)

r7 - [15 Apr 2009 - 15:09](#)

ConventionalSystems

[PaulOpitz](#)

r8 - [13 Apr 2009 - 19:56](#)

DecipheringTrunkedSystems

[PaulOpitz](#)

r4 - [24 Mar 2009 - 19:09](#)

[EDACSSCATSystems](#)

[PaulOpitz](#)

r5 - [13 Apr 2009 - 20:02](#)

[EDACSTrunkedSystems](#)

[PaulOpitz](#)

r6 - [13 Apr 2009 - 20:10](#)

[EditBandPlan](#)

[PaulOpitz](#)

r5 - [30 Mar 2009 - 17:16](#)

[EditChannel](#)

[PaulOpitz](#)

r6 - [15 Apr 2009 - 15:17](#)

[EditGroup](#)

[PaulOpitz](#)

r5 - [13 Apr 2009 - 20:25](#)

[EditSite](#)

[PaulOpitz](#)

r5 - [13 Apr 2009 - 20:27](#)

[EditSysOption](#)

[PaulOpitz](#)

r6 - [15 Apr 2009 - 15:20](#)

[EditTalkGroupID](#)

[PaulOpitz](#)

r8 - [13 Apr 2009 - 20:44](#)

[FCCInformation](#)

[PaulOpitz](#)

r7 - [24 Mar 2009 - 19:30](#)

[GeneralPrecautions](#)

[PaulOpitz](#)

r7 - [24 Mar 2009 - 19:32](#)

[IntroductionToSAMEMessages](#)

[PaulOpitz](#)

r6 - [15 Apr 2009 - 15:26](#)

[LTRTrunkedSystems](#)

[PaulOpitz](#)

r7 - [15 Apr 2009 - 15:34](#)

[LocationBasedScanning](#)

[PaulOpitz](#)

r4 - [24 Mar 2009 - 19:41](#)

[MobileConnectingAGPSReceiver](#)

[PaulOpitz](#)

r3 - [31 Mar 2009 - 20:59](#)

[MobileSettingUpTheHardware](#)

[PaulOpitz](#)

r4 - [13 Apr 2009 - 21:35](#)

[MobileWiredClone](#)

[PaulOpitz](#)

r4 - [01 Apr 2009 - 19:05](#)

[MotorolaFleetMaps](#)

[PaulOpitz](#)

r4 - [24 Mar 2009 - 19:45](#)

[MotorolaTrunkedSystems](#)

[PaulOpitz](#)

r11 - [16 Apr 2009 - 15:10](#)

[NumberTags](#)

[PaulOpitz](#)

r6 - [14 Apr 2009 - 15:17](#)

PriorityScan

[PaulOpitz](#)

r5 - [06 Apr 2009 - 22:25](#)

ProgramLocation

[PaulOpitz](#)

r5 - [14 Apr 2009 - 15:22](#)

ProgramSystem

[PaulOpitz](#)

r6 - [14 Apr 2009 - 15:24](#)

ProgrammingLocations

[PaulOpitz](#)

r4 - [24 Mar 2009 - 20:43](#)

PublishContribHistory

[PaulOpitz](#)

r21 - [16 Apr 2009 - 19:16](#)

QuickKeys

[PaulOpitz](#)

r4 - [24 Mar 2009 - 20:46](#)

RadioSystemsOverview

[PaulOpitz](#)

r5 - [24 Mar 2009 - 20:47](#)

ReadingTheDisplay

[PaulOpitz](#)

r6 - [09 Apr 2009 - 15:33](#)

ScanningLegally

[PaulOpitz](#)

r7 - [24 Mar 2009 - 20:54](#)

SearchAndStore

[PaulOpitz](#)

r4 - [24 Mar 2009 - 20:54](#)

[SearchFor](#)

[PaulOpitz](#)

r5 - [14 Apr 2009 - 15:40](#)

[SearchKeys](#)

[PaulOpitz](#)

r5 - [14 Apr 2009 - 15:44](#)

[SearchWithScan](#)

[PaulOpitz](#)

r6 - [14 Apr 2009 - 15:53](#)

[SetAlertTone](#)

[PaulOpitz](#)

r4 - [24 Mar 2009 - 21:00](#)

[SetFrequencies](#)

[PaulOpitz](#)

r5 - [14 Apr 2009 - 16:08](#)

[SetLocationInfo](#)

[PaulOpitz](#)

r5 - [14 Apr 2009 - 16:11](#)

[SettingAlerts](#)

[PaulOpitz](#)

r4 - [24 Mar 2009 - 21:03](#)

[SingleFrequencyP25TrunkedSystems](#)

[PaulOpitz](#)

r6 - [14 Apr 2009 - 16:24](#)

[SrchCloCallOpt](#)

[PaulOpitz](#)

r6 - [15 Apr 2009 - 15:36](#)

[StandardP25TrunkedSystems](#)

[PaulOpitz](#)

r8 - [15 Apr 2009 - 15:38](#)

[StartupKeys](#)

[PaulOpitz](#)

r4 - [24 Mar 2009 - 21:50](#)

[ToneAAndToneBSettings](#)

[PaulOpitz](#)

r4 - [24 Mar 2009 - 22:09](#)

[ToneOutFor](#)

[PaulOpitz](#)

r7 - [14 Apr 2009 - 18:14](#)

[UnidenScannersUsersGuides](#)

[PaulOpitz](#)

r13 - [16 Apr 2009 - 20:06](#)

[UsingQuickKeysStartupKeysAndSearchKeys](#)

[PaulOpitz](#)

r4 - [24 Mar 2009 - 22:15](#)

[WXOperation](#)

[PaulOpitz](#)

r7 - [15 Apr 2009 - 15:40](#)

[WarrantyAndSupportInformation](#)

[PaulOpitz](#)

r7 - [24 Mar 2009 - 22:17](#)

[WeatherMode](#)

[PaulOpitz](#)

r5 - [14 Apr 2009 - 18:16](#)

Number of topics: 65



Results from UnidenManBeta web retrieved at 20:07 (GMT)

[AnalogEditChannel](#)

[PaulOpitz](#)

r4 - [24 Mar 2009 - 15:32](#)

[AnalogEditTalkGroupID](#)

[PaulOpitz](#)

r4 - [24 Mar 2009 - 15:22](#)

[AnalogSiteOptions](#)

[PaulOpitz](#)

r4 - [24 Mar 2009 - 16:10](#)

[AnalogToneOutFor](#)

[PaulOpitz](#)

r5 - [24 Mar 2009 - 16:22](#)

[AnalogWXOperation](#)

[PaulOpitz](#)

r4 - [24 Mar 2009 - 16:25](#)

[AvailableOperationModes](#)

[PaulOpitz](#)

r14 - [15 Apr 2009 - 15:00](#)

[BC346XTSysOption](#)

[PaulOpitz](#)

r4 - [24 Mar 2009 - 16:23](#)

[CalculatingUpperBaseFrequencies](#)

[PaulOpitz](#)

r5 - [24 Mar 2009 - 18:31](#)

CategoryBCT15X

[PaulOpitz](#)

NEW - [26 Mar 2009 - 18:39](#)

CloseCall

[PaulOpitz](#)

r7 - [15 Apr 2009 - 15:09](#)

ConventionalSystems

[PaulOpitz](#)

r8 - [13 Apr 2009 - 19:56](#)

DecipheringTrunkedSystems

[PaulOpitz](#)

r4 - [24 Mar 2009 - 19:09](#)

EDACSSCATSystems

[PaulOpitz](#)

r5 - [13 Apr 2009 - 20:02](#)

EDACSTrunkedSystems

[PaulOpitz](#)

r6 - [13 Apr 2009 - 20:10](#)

EditBandPlan

[PaulOpitz](#)

r5 - [30 Mar 2009 - 17:16](#)

EditGroup

[PaulOpitz](#)

r5 - [13 Apr 2009 - 20:25](#)

EditSite

[PaulOpitz](#)

r5 - [13 Apr 2009 - 20:27](#)

EditSysOption

[PaulOpitz](#)

r6 - [15 Apr 2009 - 15:20](#)

EditTalkGroupID

[PaulOpitz](#)

r8 - [13 Apr 2009 - 20:44](#)

FCCInformation

[PaulOpitz](#)

r7 - [24 Mar 2009 - 19:30](#)

GeneralPrecautions

[PaulOpitz](#)

r7 - [24 Mar 2009 - 19:32](#)

IntroductionToSAMEMessages

[PaulOpitz](#)

r6 - [15 Apr 2009 - 15:26](#)

LTRTrunkedSystems

[PaulOpitz](#)

r7 - [15 Apr 2009 - 15:34](#)

LocationBasedScanning

[PaulOpitz](#)

r4 - [24 Mar 2009 - 19:41](#)

MobileConnectingAGPSReceiver

[PaulOpitz](#)

r3 - [31 Mar 2009 - 20:59](#)

MobileSettingUpTheHardware

[PaulOpitz](#)

r4 - [13 Apr 2009 - 21:35](#)

MobileWiredClone

[PaulOpitz](#)

r4 - [01 Apr 2009 - 19:05](#)

MotorolaFleetMaps

[PaulOpitz](#)

r4 - [24 Mar 2009 - 19:45](#)

[MotorolaTrunkedSystems](#)

[PaulOpitz](#)

r11 - [16 Apr 2009 - 15:10](#)

[NumberTags](#)

[PaulOpitz](#)

r6 - [14 Apr 2009 - 15:17](#)

[PriorityScan](#)

[PaulOpitz](#)

r5 - [06 Apr 2009 - 22:25](#)

[ProgramLocation](#)

[PaulOpitz](#)

r5 - [14 Apr 2009 - 15:22](#)

[ProgrammingLocations](#)

[PaulOpitz](#)

r4 - [24 Mar 2009 - 20:43](#)

[PublishContribHistory](#)

[PaulOpitz](#)

r21 - [16 Apr 2009 - 19:16](#)

[QuickKeys](#)

[PaulOpitz](#)

r4 - [24 Mar 2009 - 20:46](#)

[RadioSystemsOverview](#)

[PaulOpitz](#)

r5 - [24 Mar 2009 - 20:47](#)

[ScanningLegally](#)

[PaulOpitz](#)

r7 - [24 Mar 2009 - 20:54](#)

SearchAndStore

[PaulOpitz](#)

r4 - [24 Mar 2009 - 20:54](#)

SearchKeys

[PaulOpitz](#)

r5 - [14 Apr 2009 - 15:44](#)

SearchWithScan

[PaulOpitz](#)

r6 - [14 Apr 2009 - 15:53](#)

SetAlertTone

[PaulOpitz](#)

r4 - [24 Mar 2009 - 21:00](#)

SetFrequencies

[PaulOpitz](#)

r5 - [14 Apr 2009 - 16:08](#)

SetLocationInfo

[PaulOpitz](#)

r5 - [14 Apr 2009 - 16:11](#)

SettingAlerts

[PaulOpitz](#)

r4 - [24 Mar 2009 - 21:03](#)

StartupKeys

[PaulOpitz](#)

r4 - [24 Mar 2009 - 21:50](#)

ToneAAndToneBSettings

[PaulOpitz](#)

r4 - [24 Mar 2009 - 22:09](#)

UnidenScannersUsersGuides

[PaulOpitz](#)

r13 - [16 Apr 2009 - 20:06](#)

[UsingQuickKeysStartupKeysAndSearchKeys](#)

[PaulOpitz](#)

r4 - [24 Mar 2009 - 22:15](#)

[WarrantyAndSupportInformation](#)

[PaulOpitz](#)

r7 - [24 Mar 2009 - 22:17](#)

[WeatherMode](#)

[PaulOpitz](#)

r5 - [14 Apr 2009 - 18:16](#)

Number of topics: 50

Results from UnidenManBeta web retrieved at 20:07 (GMT)

[AvailableOperationModes](#)

[PaulOpitz](#)

r14 - [15 Apr 2009 - 15:00](#)

[BCD396XT](#)

[PaulOpitz](#)

r12 - [16 Apr 2009 - 19:09](#)

[BCD396XTSpecs](#)

[PaulOpitz](#)

r8 - [16 Apr 2009 - 19:10](#)

[BandScopeMode](#)

[PaulOpitz](#)

r5 - [15 Apr 2009 - 15:58](#)

[CalculatingUpperBaseFrequencies](#)

[PaulOpitz](#)

r5 - [24 Mar 2009 - 18:31](#)

[CategoryBCD396XT](#)

[PaulOpitz](#)

r2 - [24 Mar 2009 - 18:33](#)

[CloseCall](#)

[PaulOpitz](#)

r7 - [15 Apr 2009 - 15:09](#)

[CloseCallMode](#)

[PaulOpitz](#)

r5 - [25 Mar 2009 - 15:44](#)

[ConnectingAGPSReceiver](#)

[PaulOpitz](#)

r4 - [24 Mar 2009 - 18:41](#)

ConventionalSystems

[PaulOpitz](#)

r8 - [13 Apr 2009 - 19:56](#)

DecipheringTrunkedSystems

[PaulOpitz](#)

r4 - [24 Mar 2009 - 19:09](#)

EDACSSCATSystems

[PaulOpitz](#)

r5 - [13 Apr 2009 - 20:02](#)

EDACSTrunkedSystems

[PaulOpitz](#)

r6 - [13 Apr 2009 - 20:10](#)

EditBandPlan

[PaulOpitz](#)

r5 - [30 Mar 2009 - 17:16](#)

EditChannel

[PaulOpitz](#)

r6 - [15 Apr 2009 - 15:17](#)

EditGroup

[PaulOpitz](#)

r5 - [13 Apr 2009 - 20:25](#)

EditSite

[PaulOpitz](#)

r5 - [13 Apr 2009 - 20:27](#)

EditSysOption

[PaulOpitz](#)

r6 - [15 Apr 2009 - 15:20](#)

EditTalkGroupID

[PaulOpitz](#)

r8 - [13 Apr 2009 - 20:44](#)

FCCInformation

[PaulOpitz](#)

r7 - [24 Mar 2009 - 19:30](#)

GPSMode

[PaulOpitz](#)

r5 - [24 Mar 2009 - 19:31](#)

GeneralPrecautions

[PaulOpitz](#)

r7 - [24 Mar 2009 - 19:32](#)

HoldMode

[PaulOpitz](#)

r4 - [24 Mar 2009 - 19:33](#)

IntroductionToSAMEMessages

[PaulOpitz](#)

r6 - [15 Apr 2009 - 15:26](#)

KeySafeMode

[PaulOpitz](#)

r4 - [24 Mar 2009 - 19:37](#)

KeysAndTheirFunctions

[PaulOpitz](#)

r5 - [06 Apr 2009 - 22:24](#)

LTRTrunkedSystems

[PaulOpitz](#)

r7 - [15 Apr 2009 - 15:34](#)

LocationBasedScanning

[PaulOpitz](#)

r4 - [24 Mar 2009 - 19:41](#)

MenuTree

[PaulOpitz](#)

r6 - [24 Mar 2009 - 19:45](#)

[MotorolaFleetMaps](#)

[PaulOpitz](#)

r4 - [24 Mar 2009 - 19:45](#)

[MotorolaTrunkedSystems](#)

[PaulOpitz](#)

r11 - [16 Apr 2009 - 15:10](#)

[NumberTags](#)

[PaulOpitz](#)

r6 - [14 Apr 2009 - 15:17](#)

[PriorityScan](#)

[PaulOpitz](#)

r5 - [06 Apr 2009 - 22:25](#)

[ProgramLocation](#)

[PaulOpitz](#)

r5 - [14 Apr 2009 - 15:22](#)

[ProgramSystem](#)

[PaulOpitz](#)

r6 - [14 Apr 2009 - 15:24](#)

[ProgrammingLocations](#)

[PaulOpitz](#)

r4 - [24 Mar 2009 - 20:43](#)

[PublishContribHistory](#)

[PaulOpitz](#)

r21 - [16 Apr 2009 - 19:16](#)

[RadioSystemsOverview](#)

[PaulOpitz](#)

r5 - [24 Mar 2009 - 20:47](#)

ReadingTheDisplay

[PaulOpitz](#)

r6 - [09 Apr 2009 - 15:33](#)

ScanMode

[PaulOpitz](#)

r5 - [25 Mar 2009 - 21:04](#)

ScanningLegally

[PaulOpitz](#)

r7 - [24 Mar 2009 - 20:54](#)

SearchAndStore

[PaulOpitz](#)

r4 - [24 Mar 2009 - 20:54](#)

SearchFor

[PaulOpitz](#)

r5 - [14 Apr 2009 - 15:40](#)

SearchKeys

[PaulOpitz](#)

r5 - [14 Apr 2009 - 15:44](#)

SearchWithScan

[PaulOpitz](#)

r6 - [14 Apr 2009 - 15:53](#)

SetAlertTone

[PaulOpitz](#)

r4 - [24 Mar 2009 - 21:00](#)

SetFrequencies

[PaulOpitz](#)

r5 - [14 Apr 2009 - 16:08](#)

SetLocationInfo

[PaulOpitz](#)

r5 - [14 Apr 2009 - 16:11](#)

[SettingAlerts](#)

[PaulOpitz](#)

r4 - [24 Mar 2009 - 21:03](#)

[SettingUpTheHardware](#)

[PaulOpitz](#)

r7 - [24 Mar 2009 - 21:07](#)

[Settings](#)

[PaulOpitz](#)

r5 - [16 Apr 2009 - 18:56](#)

[SingleFrequencyP25TrunkedSystems](#)

[PaulOpitz](#)

r6 - [14 Apr 2009 - 16:24](#)

[SrchCloCallOpt](#)

[PaulOpitz](#)

r6 - [15 Apr 2009 - 15:36](#)

[StandardP25TrunkedSystems](#)

[PaulOpitz](#)

r8 - [15 Apr 2009 - 15:38](#)

[StartupKeys](#)

[PaulOpitz](#)

r4 - [24 Mar 2009 - 21:50](#)

[ToneAAndToneBSettings](#)

[PaulOpitz](#)

r4 - [24 Mar 2009 - 22:09](#)

[ToneOutFor](#)

[PaulOpitz](#)

r7 - [14 Apr 2009 - 18:14](#)

[ToneOutMode](#)

[PaulOpitz](#)

r5 - [01 Apr 2009 - 15:40](#)

[UnidenScannersUsersGuides](#)

[PaulOpitz](#)

r13 - [16 Apr 2009 - 20:06](#)

[UsingQuickKeysStartupKeysAndSearchKeys](#)

[PaulOpitz](#)

r4 - [24 Mar 2009 - 22:15](#)

[WXOperation](#)

[PaulOpitz](#)

r7 - [15 Apr 2009 - 15:40](#)

[WarrantyAndSupportInformation](#)

[PaulOpitz](#)

r7 - [24 Mar 2009 - 22:17](#)

[WeatherMode](#)

[PaulOpitz](#)

r5 - [14 Apr 2009 - 18:16](#)

[WiredClone](#)

[PaulOpitz](#)

r4 - [24 Mar 2009 - 22:18](#)

Number of topics: 64

Results from UnidenManBeta web retrieved at 20:07 (GMT)

[AnalogEditChannel](#)

[PaulOpitz](#)

r4 - [24 Mar 2009 - 15:32](#)

[AnalogEditTalkGroupID](#)

[PaulOpitz](#)

r4 - [24 Mar 2009 - 15:22](#)

[AnalogProgramSystem](#)

[PaulOpitz](#)

r4 - [24 Mar 2009 - 16:10](#)

[AnalogSiteOptions](#)

[PaulOpitz](#)

r4 - [24 Mar 2009 - 16:10](#)

[AnalogToneOutFor](#)

[PaulOpitz](#)

r5 - [24 Mar 2009 - 16:22](#)

[AnalogWXOperation](#)

[PaulOpitz](#)

r4 - [24 Mar 2009 - 16:25](#)

[AvailableOperationModes](#)

[PaulOpitz](#)

r14 - [15 Apr 2009 - 15:00](#)

[BC346XT](#)

[PaulOpitz](#)

r11 - [16 Apr 2009 - 20:02](#)

[BC346XTDisplays](#)

[PaulOpitz](#)

r6 - [16 Apr 2009 - 19:02](#)

BC346XTHoldMode

[PaulOpitz](#)

r4 - [24 Mar 2009 - 15:48](#)

BC346XTSearchFor

[PaulOpitz](#)

r4 - [24 Mar 2009 - 15:57](#)

BC346XTSettings

[PaulOpitz](#)

r4 - [24 Mar 2009 - 16:00](#)

BC346XTSpecs

[PaulOpitz](#)

r6 - [24 Mar 2009 - 16:13](#)

BC346XTSrchCloCallOpt

[PaulOpitz](#)

r4 - [24 Mar 2009 - 16:14](#)

BC346XTSysOption

[PaulOpitz](#)

r4 - [24 Mar 2009 - 16:23](#)

BandScopeMode

[PaulOpitz](#)

r5 - [15 Apr 2009 - 15:58](#)

CalculatingUpperBaseFrequencies

[PaulOpitz](#)

r5 - [24 Mar 2009 - 18:31](#)

CategoryBC346XT

[PaulOpitz](#)

r2 - [24 Mar 2009 - 18:32](#)

CloseCall

[PaulOpitz](#)

r7 - [15 Apr 2009 - 15:09](#)

[CloseCallMode](#)

[PaulOpitz](#)

r5 - [25 Mar 2009 - 15:44](#)

[ConnectingAGPSReceiver](#)

[PaulOpitz](#)

r4 - [24 Mar 2009 - 18:41](#)

[ConventionalSystems](#)

[PaulOpitz](#)

r8 - [13 Apr 2009 - 19:56](#)

[DecipheringTrunkedSystems](#)

[PaulOpitz](#)

r4 - [24 Mar 2009 - 19:09](#)

[EDACSSCATSystems](#)

[PaulOpitz](#)

r5 - [13 Apr 2009 - 20:02](#)

[EDACSTrunkedSystems](#)

[PaulOpitz](#)

r6 - [13 Apr 2009 - 20:10](#)

[EditBandPlan](#)

[PaulOpitz](#)

r5 - [30 Mar 2009 - 17:16](#)

[EditGroup](#)

[PaulOpitz](#)

r5 - [13 Apr 2009 - 20:25](#)

[EditSite](#)

[PaulOpitz](#)

r5 - [13 Apr 2009 - 20:27](#)

[EditSysOption](#)

[PaulOpitz](#)

r6 - [15 Apr 2009 - 15:20](#)

[EditTalkGroupID](#)

[PaulOpitz](#)

r8 - [13 Apr 2009 - 20:44](#)

[FCCInformation](#)

[PaulOpitz](#)

r7 - [24 Mar 2009 - 19:30](#)

[GPSMode](#)

[PaulOpitz](#)

r5 - [24 Mar 2009 - 19:31](#)

[GeneralPrecautions](#)

[PaulOpitz](#)

r7 - [24 Mar 2009 - 19:32](#)

[HoldMode](#)

[PaulOpitz](#)

r4 - [24 Mar 2009 - 19:33](#)

[IntroductionToSAMEMessages](#)

[PaulOpitz](#)

r6 - [15 Apr 2009 - 15:26](#)

[KeySafeMode](#)

[PaulOpitz](#)

r4 - [24 Mar 2009 - 19:37](#)

[KeysAndTheirFunctions](#)

[PaulOpitz](#)

r5 - [06 Apr 2009 - 22:24](#)

[LTRTrunkedSystems](#)

[PaulOpitz](#)

r7 - [15 Apr 2009 - 15:34](#)

LocationBasedScanning

PaulOpitz

r4 - 24 Mar 2009 - 19:41

MenuReference

PaulOpitz

r4 - 24 Mar 2009 - 19:57

MotorolaFleetMaps

PaulOpitz

r4 - 24 Mar 2009 - 19:45

MotorolaTrunkedSystems

PaulOpitz

r11 - 16 Apr 2009 - 15:10

NumberTags

PaulOpitz

r6 - 14 Apr 2009 - 15:17

PriorityScan

PaulOpitz

r5 - 06 Apr 2009 - 22:25

ProgramLocation

PaulOpitz

r5 - 14 Apr 2009 - 15:22

ProgrammingLocations

PaulOpitz

r4 - 24 Mar 2009 - 20:43

PublishContribHistory

PaulOpitz

r21 - 16 Apr 2009 - 19:16

QuickKeys

PaulOpitz

r4 - [24 Mar 2009 - 20:46](#)

[RadioSystemsOverview](#)

[PaulOpitz](#)

r5 - [24 Mar 2009 - 20:47](#)

[ScanMode](#)

[PaulOpitz](#)

r5 - [25 Mar 2009 - 21:04](#)

[ScanningLegally](#)

[PaulOpitz](#)

r7 - [24 Mar 2009 - 20:54](#)

[SearchAndStore](#)

[PaulOpitz](#)

r4 - [24 Mar 2009 - 20:54](#)

[SearchKeys](#)

[PaulOpitz](#)

r5 - [14 Apr 2009 - 15:44](#)

[SearchWithScan](#)

[PaulOpitz](#)

r6 - [14 Apr 2009 - 15:53](#)

[SetAlertTone](#)

[PaulOpitz](#)

r4 - [24 Mar 2009 - 21:00](#)

[SetFrequencies](#)

[PaulOpitz](#)

r5 - [14 Apr 2009 - 16:08](#)

[SetLocationInfo](#)

[PaulOpitz](#)

r5 - [14 Apr 2009 - 16:11](#)

[SettingAlerts](#)

[PaulOpitz](#)

r4 - [24 Mar 2009 - 21:03](#)

[SettingUpTheHardware](#)

[PaulOpitz](#)

r7 - [24 Mar 2009 - 21:07](#)

[StartupKeys](#)

[PaulOpitz](#)

r4 - [24 Mar 2009 - 21:50](#)

[ToneAAndToneBSettings](#)

[PaulOpitz](#)

r4 - [24 Mar 2009 - 22:09](#)

[ToneOutFor](#)

[PaulOpitz](#)

r7 - [14 Apr 2009 - 18:14](#)

[ToneOutMode](#)

[PaulOpitz](#)

r5 - [01 Apr 2009 - 15:40](#)

[UnidenScannersUsersGuides](#)

[PaulOpitz](#)

r13 - [16 Apr 2009 - 20:06](#)

[UsingQuickKeysStartupKeysAndSearchKeys](#)

[PaulOpitz](#)

r4 - [24 Mar 2009 - 22:15](#)

[WarrantyAndSupportInformation](#)

[PaulOpitz](#)

r7 - [24 Mar 2009 - 22:17](#)

[WeatherMode](#)

[PaulOpitz](#)

r5 - [14 Apr 2009 - 18:16](#)

[WiredClone](#)

[PaulOpitz](#)

r4 - [24 Mar 2009 - 22:18](#)

Number of topics: 68

Searched: **CategoryUsersGuide**

Results from UnidenManBeta web retrieved at 20:07 (GMT)

[AnalogEditChannel](#)

[PaulOpitz](#)

r4 - [24 Mar 2009 - 15:32](#)

This menu lets you create channels and edit existing channels. All existing channels are listed in alphabetical order: select the channel you want to edit, or select ...

[AnalogEditTalkGroupID](#)

[PaulOpitz](#)

r4 - [24 Mar 2009 - 15:22](#)

All Talk Group IDs must be in the proper format for each system type. Motorola Type I Systems Enter the Talk Group ID in the following format: BFFF SS B ...

[AnalogProgramSystem](#)

[PaulOpitz](#)

r4 - [24 Mar 2009 - 16:10](#)

The Program System menu lets you create systems and edit existing systems. All existing systems are listed in alphabetical order: select the system you want to edit ...

[AnalogSiteOptions](#)

[PaulOpitz](#)

r4 - [24 Mar 2009 - 16:10](#)

Site Options When you create a new site, the scanner automatically assigns a default site name using the following pattern Site XXX YYY TTT where XXX is a 3 digit ...

[AnalogToneOutFor](#)

[PaulOpitz](#)

r5 - [24 Mar 2009 - 16:22](#)

Tone Out Standby Check the tone out channels for paging tones, according to each channel's individual settings. Tone Out Setup This menu lets you configure the 10 ...

[AnalogWXOperation](#)

[PaulOpitz](#)

r4 - [24 Mar 2009 - 16:25](#)

WX Operation This menu lets you configure how the scanner operates in Weather (WX) mode and Weather Alert (WX Alert) mode. Weather Scan Start a normal weather scan ...

[AvailableOperationModes](#)

[PaulOpitz](#)

r14 - [15 Apr 2009 - 15:00](#)

Available Operation Modes The scanner has several different operation modes; in each mode, the scanner's operation, display, and key functions can be completely different ...

[BC346XT](#)

[PaulOpitz](#)

r11 - [16 Apr 2009 - 20:02](#)

BC346XT Important information For general information about using a scanner, we suggest you start with the General Users Guide page. General Precautions Specifications ...

[BC346XTDisplays](#)

[PaulOpitz](#)

r6 - [16 Apr 2009 - 19:02](#)

BC346XT displays The display icons vary depending on the status of the scanner and what youre doing at any given time. The diagram shows common icon locations, and ...

[BC346XTHoldMode](#)

[PaulOpitz](#)

r4 - [24 Mar 2009 - 15:48](#)

BC346XT Hold mode Hold mode lets you edit the current frequency, system, site, or channel. You can access these functions by using the different key operations: ...

[BC346XTSearchFor](#)

[PaulOpitz](#)

r4 - [24 Mar 2009 - 15:57](#)

BC346XT Search for... Use this menu to start a search, to change the options for the three different types of searches, and program the 3 search keys. Service Search ...

[BC346XTSettings](#)

[PaulOpitz](#)

r4 - [24 Mar 2009 - 16:00](#)

BC346XT Settings Set Backlight This menu lets you configure the display and key backlight. Set Mode Choose how you want the backlight to operate: 10 sec The ...

[BC346XTSpecs](#)

[PaulOpitz](#)

r6 - [24 Mar 2009 - 16:13](#)

BC346XT Specs Certified in accordance with FCC Rules and Regulations Part 15 Subpart C as of date of manufacture. (See FCC Information for more details.) ...

[BC346XTSrchCloCallOpt](#)

[PaulOpitz](#)

r4 - [24 Mar 2009 - 16:14](#)

BC346XT Srch/CloCall Opt This menu lets you set general options for how the scanner operates in Search and Close Call modes. Freq Lockouts Rvw Search L/O ...

[BC346XTSysOption](#)

[PaulOpitz](#)

r4 - [24 Mar 2009 - 16:23](#)

System options vary depending on the system type. Global system options The following options are available for all types of systems. Set Number Tag Set Delay Time ...

[BCD396XT](#)

[PaulOpitz](#)

r12 - [16 Apr 2009 - 19:09](#)

BCD396XT Important information For general information about using a scanner, we suggest you start with the General Users Guide page. General Precautions Specifications ...

[BCD396XTSpecs](#)

[PaulOpitz](#)

r8 - [16 Apr 2009 - 19:10](#)

BCD396XT Specs Certified in accordance with FCC Rules and Regulations Part 15 Subpart C as of date of manufacture. (See FCC Information for more details.) ...

[BCD996XT](#)

[PaulOpitz](#)

r11 - [16 Apr 2009 - 20:04](#)

BCD996XT Important information For general information about using a scanner, including how to program the various types of radio systems into your scanner, we suggest ...

[BCD996XTBandScopeMode](#)

[PaulOpitz](#)

r4 - [15 Apr 2009 - 16:00](#)

Band Scope mode Band Scope mode is a special type of Search mode where the scanner displays the strength of any signal it finds. In a band scope search, the ...

[BCD996XTCloseCallMode](#)

[PaulOpitz](#)

r6 - [13 Apr 2009 - 16:26](#)

Close Call Mode When the scanner is in Close Call mode, it performs a close call check every 2 seconds. The scanner switches to the selected bands and searches for ...

[BCD996XTGPSMode](#)

[PaulOpitz](#)

r6 - [13 Apr 2009 - 16:34](#)

GPS Mode You must have a compatible GPS receiver connected! See Also GPS mode is only one small part of location based scanning. For more information on using your ...

[BCD996XTHoldMode](#)

[PaulOpitz](#)

r4 - [13 Apr 2009 - 18:52](#)

Hold mode Hold mode lets you edit the current frequency, system, site, or channel. You can access these functions by using the different key operations: Key Operation ...

[BCD996XTKeySafeMode](#)

[PaulOpitz](#)

r5 - [13 Apr 2009 - 18:58](#)

Key Safe Mode Key Safe mode locks out the programming menu and more advanced functions so the user can't accidentally "break" the scanner. This mode is ideal for any ...

[BCD996XTKeysAndTheirFunctions](#)

[PaulOpitz](#)

r3 - [31 Mar 2009 - 20:33](#)

Keys and their functions Key Overview The diagram below shows the keys and what they are called throughout the guide: Operating the controls Each button has at ...

[BCD996XTMenuTree](#)

[PaulOpitz](#)

r5 - [13 Apr 2009 - 18:59](#)

Menu tree BCD996XT main menu Program System Program Location Srch/CloCall Opt Search for... Close Call Priority Scan WX Operation ...

[BCD996XTScanMode](#)

[PaulOpitz](#)

r7 - [13 Apr 2009 - 19:06](#)

Scan mode Scanning vs. Searching Scan and Search mode have very similar operations. In both Scan and Search modes, the scanner steps through a set of frequencies ...

[BCD996XTSettings](#)

[PaulOpitz](#)

r5 - [13 Apr 2009 - 19:07](#)

BCD996XT Settings Set Backlight This menu lets you configure the display and key backlight. Set Dimmer Selects whether the backlight brightness is set automatically ...

[BCD996XTSpecs](#)

[PaulOpitz](#)

r9 - [16 Apr 2009 - 19:12](#)

BCD996XT Specs Certified in accordance with FCC Rules and Regulations Part 15 Subpart C as of date of manufacture. (See FCC Information for more details.) ...

[BCD996XTToneOutMode](#)

[PaulOpitz](#)

r3 - [13 Apr 2009 - 19:31](#)

Tone Out mode With the tone out feature, the scanner monitors up to 10 different channels for paging tones (two tone sequential, single tone, and group tone). Normally ...

[BandScopeMode](#)

[PaulOpitz](#)

r5 - [15 Apr 2009 - 15:58](#)

Band Scope mode Band Scope mode is a special type of Search mode where the scanner displays the strength of any signal it finds. In a band scope search, the ...

[CalculatingUpperBaseFrequencies](#)

[PaulOpitz](#)

r5 - [24 Mar 2009 - 18:31](#)

Calculating upper base frequencies Custom Band Plans (800 Custom, VHF, UHF) require that you enter both a lower and an upper base frequency value. Here's how to determine ...

CategoryPending

[PaulOpitz](#)

r4 - [24 Mar 2009 - 18:33](#)

CategoryUsersGuide

[PaulOpitz](#)

r2 - [24 Mar 2009 - 18:34](#)

CloseCall

[PaulOpitz](#)

r7 - [15 Apr 2009 - 15:09](#)

Close Call The Close Call (CC) feature searches for signals that are stronger than other signals on the band (indicating the transmitter is probably somewhere close ...

CloseCallMode

[PaulOpitz](#)

r5 - [25 Mar 2009 - 15:44](#)

Close Call mode When the scanner is in Close Call mode, it performs a close call check every 2 seconds. The scanner switches to the selected bands and searches for ...

ConnectingAGPSReceiver

[PaulOpitz](#)

r4 - [24 Mar 2009 - 18:41](#)

Connecting a GPS receiver Compatible GPS receivers You can connect your scanner to any GPS receiver that meets the following criteria: Outputs NMEA 0183 v3.01 ...

ConventionalSystems

[PaulOpitz](#)

r8 - [13 Apr 2009 - 19:56](#)

Conventional Systems Since a conventional system is really a collection of frequencies, the first thing you need to know is the frequency for each channel you want ...

DecipheringTrunkedSystems

[PaulOpitz](#)

r4 - [24 Mar 2009 - 19:09](#)

Deciphering Trunked Systems Before you program a trunked system To the average radio user, the complexity of a trunked system is invisible. Their radio is programmed ...

EDACSSCATSystems

[PaulOpitz](#)

r5 - [13 Apr 2009 - 20:02](#)

EDACS SCAT Systems This section deals with EDACS SCAT systems. Click here for information on EDACS Wide and Narrow systems. Below is an example of an EDACS SCAT system ...

[EDACSTrunkedSystems](#)

[PaulOpitz](#)

r6 - [13 Apr 2009 - 20:10](#)

EDACS Trunked Systems This section deals with EDACS Wide or standard systems. Click here for information on EDACS SCAT systems. This includes EDACS systems that use ...

[EditBandPlan](#)

[PaulOpitz](#)

r5 - [30 Mar 2009 - 17:16](#)

Edit Band Plan (Motorola systems only) The scanner prompts you to choose one of the two standard band plan types: 800/900 Standard or 800 Splinter . Choose Custom ...

[EditChannel](#)

[PaulOpitz](#)

r6 - [15 Apr 2009 - 15:17](#)

Edit Channel This menu lets you create channels and edit existing channels. All existing channels are listed in alphabetical order: select the channel you want to ...

[EditGroup](#)

[PaulOpitz](#)

r5 - [13 Apr 2009 - 20:25](#)

Edit Group When you create a new channel group, the scanner automatically assigns a default name of Group XX, where XX is a 2 digit sequential number (1 through 20 ...

[EditSite](#)

[PaulOpitz](#)

r5 - [13 Apr 2009 - 20:27](#)

Edit Site When you create a new site, the scanner automatically assigns a default site name using the following pattern Site XXX YYY TTT where XXX is a 3 digit ...

[EditSysOption](#)

[PaulOpitz](#)

r6 - [15 Apr 2009 - 15:20](#)

Edit Sys Option System options vary depending on the system type. Global system options The following options are available for all types of systems. Set Number ...

[**EditTalkGroupID**](#)

[PaulOpitz](#)

r8 - [13 Apr 2009 - 20:44](#)

Edit Talk Group ID All Talk Group IDs must be in the proper format for each system type. Motorola Type I Systems Enter the Talk Group ID in the following format: ...

[**FCCInformation**](#)

[PaulOpitz](#)

r7 - [24 Mar 2009 - 19:30](#)

FCC Information The FCC Wants You to Know IMPORTANT! This scanning radio has been manufactured so that it will not tune to the radio frequencies assigned by the FCC ...

[**GPSMode**](#)

[PaulOpitz](#)

r5 - [24 Mar 2009 - 19:31](#)

GPS mode You must have a compatible GPS receiver connected! See Also GPS mode is only one small part of location based scanning. For more information on using your ...

[**GeneralPrecautions**](#)

[PaulOpitz](#)

r7 - [24 Mar 2009 - 19:32](#)

General Precautions Before you use this scanner, please read and observe the following: Earphone Warning You can use an optional 32 Omega; stereo headset or earphone ...

[**HoldMode**](#)

[PaulOpitz](#)

r4 - [24 Mar 2009 - 19:33](#)

Hold mode Hold mode lets you edit the current frequency, system, site, or channel. You can access these functions by using the different key operations: Key operation ...

[**IntroductionToSAMEMessages**](#)

[PaulOpitz](#)

r6 - [15 Apr 2009 - 15:26](#)

Introduction to SAME messages Hazard alerts are transmitted with Specific Area

Message Encoding (SAME) data, which includes: Nature of the alert Hazard ...

[KeySafeMode](#)

[PaulOpitz](#)

r4 - [24 Mar 2009 - 19:37](#)

Key Safe Mode Key Safe mode locks out the programming menu and more advanced functions so the user can't accidentally "break" the scanner. This mode is ideal for any ...

[KeysAndTheirFunctions](#)

[PaulOpitz](#)

r5 - [06 Apr 2009 - 22:24](#)

Keys and their functions Key Overview The diagram below shows the keys and what they are called throughout the guide: Operating the controls Each button has at ...

[LTRTrunkedSystems](#)

[PaulOpitz](#)

r7 - [15 Apr 2009 - 15:34](#)

LTR Trunked Systems Below is an example of a Logic Trunked Radio or LTR system from RadioReference: Here is a conceptual layout diagram of a basic LTR system ...

[LocationBasedScanning](#)

[PaulOpitz](#)

r4 - [24 Mar 2009 - 19:41](#)

Location based Scanning Location based scanning allows you to control which systems/sites and channel groups are scanned based on your exact location. This frees you ...

[MenuReference](#)

[PaulOpitz](#)

r4 - [24 Mar 2009 - 19:57](#)

Menu reference BC346XT main menu Program System Program Location Srch/CloCall Opt Search for... Close Call Priority Scan WX Operation ...

[MenuTree](#)

[PaulOpitz](#)

r6 - [24 Mar 2009 - 19:45](#)

Menu tree BCD396XT main menu Program System Program Location Srch/CloCall Opt Search for... Close Call Priority Scan WX Operation ...

[MobileConnectingAGPSReceiver](#)

[PaulOpitz](#)

r3 - [31 Mar 2009 - 20:59](#)

Connecting a GPS receiver Compatible GPS receivers You can connect your scanner to any GPS receiver that meets the following criteria: Outputs NMEA 0183 v3.01 ...

[MobileSettingUpTheHardware](#)

[PaulOpitz](#)

r4 - [13 Apr 2009 - 21:35](#)

Included With Your Scanner Scanner AC Adapter Vehicle Accessory Power Cord Three Wire Harness Mounting Bracket and Hardware ...

[MobileWiredClone](#)

[PaulOpitz](#)

r4 - [01 Apr 2009 - 19:05](#)

Wired Clone This feature allows you to copy all the settings from one scanner to another of the same model: 1 Use one of the included data cables to connect the ...

[MotorolaFleetMaps](#)

[PaulOpitz](#)

r4 - [24 Mar 2009 - 19:45](#)

Motorola fleet maps Preset Fleet Maps The scanner contains 16 pre programmed fleet maps you can select. The table below gives the size code for each block of the ...

[MotorolaTrunkedSystems](#)

[PaulOpitz](#)

r11 - [16 Apr 2009 - 15:10](#)

Motorola Trunked Systems A Motorola system can be an 800 MHz, 400 MHz (UHF), or 100 200 MHz (VHF) system. Below are some examples of these Motorola systems from RadioReference ...

[NumberTags](#)

[PaulOpitz](#)

r6 - [14 Apr 2009 - 15:17](#)

Number Tags Number Tags let you quickly navigate to a specific system or channel. You can assign Number Tags at the system level (System Number Tag , ...

[PriorityScan](#)

[PaulOpitz](#)

r5 - [06 Apr 2009 - 22:25](#)

Priority Scan This section applies to conventional system priority mode only. For priority on trunked systems, turn on the Priority ID system option and set the desired ...

[ProgramLocation](#)

[PaulOpitz](#)

r5 - [14 Apr 2009 - 15:22](#)

Program Location The Program Location menu lets you create and edit points of interest (POI), intersections(Dangerous Xing), and roads (Dangerous Road ...

[ProgramSystem](#)

[PaulOpitz](#)

r6 - [14 Apr 2009 - 15:24](#)

Program System The Program System menu lets you create systems and edit existing systems. All existing systems are listed in the order they were created: select ...

[ProgrammingLocations](#)

[PaulOpitz](#)

r4 - [24 Mar 2009 - 20:43](#)

Programming locations To use Location based Scanning with a particular system, you will need to program your scanner with the geographic coordinates you want to use ...

[PublishContribHistory](#)

[PaulOpitz](#)

r21 - [16 Apr 2009 - 19:16](#)

Last Published Publisher PaulOpitz Date 16 Apr 2009 19:13 {PublishContrib}{Dir} D:/twiki/pub/publish/ {PublishContrib}{URL} http://info.uniden.com/twiki/pub ...

[QuickKeys](#)

[PaulOpitz](#)

r4 - [24 Mar 2009 - 20:46](#)

Quick Keys Quick Keys let you enable or disable systems and channel groups during a scan. Disabled systems and channel groups are ignored during scans. You ...

[RadioSystemsOverview](#)

[PaulOpitz](#)

r5 - [24 Mar 2009 - 20:47](#)

Radio Systems Overview There are two basic types of radio systems: conventional systems and trunked systems. Conventional radio systems In a conventional radio system ...

[ReadingTheDisplay](#)

[PaulOpitz](#)

r6 - [09 Apr 2009 - 15:33](#)

Reading the display The display icons vary depending on the status of the scanner and what you're doing at any given time. The diagram shows common icon locations, ...

[ScanMode](#)

[PaulOpitz](#)

r5 - [25 Mar 2009 - 21:04](#)

Scan mode Scanning vs. Searching Scan and Search mode have very similar operations. In both Scan and Search modes, the scanner steps through a set of frequencies ...

[ScanningLegally](#)

[PaulOpitz](#)

r7 - [24 Mar 2009 - 20:54](#)

Scanning Legally Your scanner covers frequencies used by many different groups, including police and fire departments, ambulance services, government agencies, private ...

[SearchAndStore](#)

[PaulOpitz](#)

r4 - [24 Mar 2009 - 20:54](#)

Search and Store With this feature, the scanner searches a system and saves any frequencies it finds activity on. When the scanner detects activity on a frequency ...

[SearchFor](#)

[PaulOpitz](#)

r5 - [14 Apr 2009 - 15:40](#)

Search for... Use this menu to start a search, to change the options for the three different types of searches, and program the 3 search keys. Service Search Start ...

[SearchKeys](#)

[PaulOpitz](#)

r5 - [14 Apr 2009 - 15:44](#)

Search Keys The scanner has three Search Keys that you can assign to a special search range; the Search Keys are set to number keys 1, 2, and 3 : Programming ...

[SearchWithScan](#)

[PaulOpitz](#)

r6 - [14 Apr 2009 - 15:53](#)

Search with Scan Set Quick Key Assign this search range to a Quick Key so you can easily enable or disable it during scanning. Enter a number from 0 to 99; tap ...

[SetAlertTone](#)

[PaulOpitz](#)

r4 - [24 Mar 2009 - 21:00](#)

Set Alert Tone Choose one of the 9 different tone patterns for the scanner to use for the alert tone: Alert 1 4000 Hz for 50 ms » Silence for 20 ms » 4000 ...

[SetFrequencies](#)

[PaulOpitz](#)

r5 - [14 Apr 2009 - 16:08](#)

Set Frequencies This menu lets you create frequencies and edit existing ones. All existing frequencies are listed in the order they were created: select the frequency ...

[SetLocationInfo](#)

[PaulOpitz](#)

r5 - [14 Apr 2009 - 16:11](#)

Set LocationInfo Use this menu to configure geographic information for each system or site. With this information and a standard NMEA GPS input, the scanner can automatically ...

[SettingAlerts](#)

[PaulOpitz](#)

r4 - [24 Mar 2009 - 21:03](#)

Setting alerts Your scanner can trigger alerts for several different events. The table below shows the different alerts and how to program them: To sound an alert ...

[SettingUpTheHardware](#)

[PaulOpitz](#)

r7 - [24 Mar 2009 - 21:07](#)

Setting up the hardware What's included Inside the box you should find: OR nop BCD396XT or nop BC346XT handheld trunking scanner ...

[Settings](#)

[PaulOpitz](#)

r5 - [16 Apr 2009 - 18:56](#)

Settings Set Backlight This menu lets you configure the display and key backlight. Set Mode Choose how you want the backlight to operate: 10 sec The scanner ...

[SingleFrequencyP25TrunkedSystems](#)

[PaulOpitz](#)

r6 - [14 Apr 2009 - 16:24](#)

Single Frequency P25 Trunked Systems Single frequency P25 systems are almost identical to standard P25 systems, except they only have one site per system and the system ...

[SrchCloCallOpt](#)

[PaulOpitz](#)

r6 - [15 Apr 2009 - 15:36](#)

Srch/CloCall Opt This menu lets you set general options for how the scanner operates in Search and Close Call modes. Freq Lockouts Rvw Search L/O : This option ...

[StandardP25TrunkedSystems](#)

[PaulOpitz](#)

r8 - [15 Apr 2009 - 15:38](#)

Standard P25 Trunked Systems This section deals with standard Project 25 or P25 systems. Click here for information on P25 one frequency systems. Below is an example ...

[StartupKeys](#)

[PaulOpitz](#)

r4 - [24 Mar 2009 - 21:50](#)

Startup Keys Startup Keys let you change the lockout state for several systems, sites, and search ranges all at the same time. When you activate the Startup Key, the ...

[ToneAAndToneBSettings](#)

[PaulOpitz](#)

r4 - [24 Mar 2009 - 22:09](#)

Tone A and Tone B Settings You can configure the scanner to search for tones in several different ways, based on the values you enter for Tone A and Tone B: Tone ...

[ToneOutFor](#)

[PaulOpitz](#)

r7 - [14 Apr 2009 - 18:14](#)

Tone Out for... Tone Out Standby Check the tone out channels for paging tones,

according to each channel's individual settings. Tone Out Setup This menu lets ...

[ToneOutMode](#)

[PaulOpitz](#)

r5 - [01 Apr 2009 - 15:40](#)

Tone Out mode With the tone out feature, the scanner monitors up to 10 different channels for paging tones (two tone sequential, single tone, and group tone). Normally ...

[UnidenScannersUsersGuides](#)

[PaulOpitz](#)

r13 - [16 Apr 2009 - 20:06](#)

Uniden Scanners Users Guides The web pages on this CD provide a guide to setting up and using your scanner. Note that we are continuously updating and improving the ...

[UserGuideInformation](#)

[PaulOpitz](#)

r5 - [24 Mar 2009 - 22:19](#)

User Guide Information Illustrations in this guide are used for explanation purposes only. Your scanner may not match the illustrations exactly. All content (including ...

[UsingQuickKeysStartupKeysAndSearchKeys](#)

[PaulOpitz](#)

r4 - [24 Mar 2009 - 22:15](#)

Using Quick Keys, Startup Keys, and Search Keys The different shortcut keys have different functions: Quick Keys Quick keys let you enable and disable systems ...

[WXOperation](#)

[PaulOpitz](#)

r7 - [15 Apr 2009 - 15:40](#)

WX Operation This menu lets you configure how the scanner operates in Weather (WX) mode and Weather Alert (WX Alert) mode. Weather Scan Start a normal weather scan ...

[WarrantyAndSupportInformation](#)

[PaulOpitz](#)

r7 - [24 Mar 2009 - 22:17](#)

Warranty and Support Information Support Information Information online www.uniden.com Email support <http://mycusthelp.com/uniden> Phone support ...

[WeatherMode](#)

[PaulOpitz](#)

r5 - [14 Apr 2009 - 18:16](#)

Weather mode Since the 10 NOAA weather channels now cooperate with the FCC and DHS to alert you of other hazards besides weather, it's important to understand how ...

[WiredClone](#)

[PaulOpitz](#)

r4 - [24 Mar 2009 - 22:18](#)

Wired Clone This feature allows you to copy all the settings from one scanner to another of the same model: 1 Use the included data cables to connect the two scanners ...

Number of topics: 97

Specifications

Limits

- Channels: 25,000 maximum
- Systems: 500 maximum
- Groups per system: 20 maximum
- Talkgroups per trunked system: 500 maximum
- Channels per conventional system: 1000 maximum
- Scan Rate: 100 channels per second (conventional mode)
- Search Rate: 300 steps per second (on 5 kHz steps)
- System Quick Key range: 0-99
- Group Quick Key range: 0-9
- Custom Search Ranges: 10
- Startup Keys: 10
- System Number Tagging: 999
- Channel Number Tagging: 999
- Preprogrammed Service Search Bands: 12
- Band Scope Span Range: 0.2 Mhz To 500 Mhz
- Band Scope Step: 5 Khz To 100 Khz

Frequency Coverage

- 25.0000 - 512.0000 MHz
- 758.0000 - 823.9875 MHz
- 849.0125 - 868.9875 MHz
- 894.0125 - 960.0000 MHz
- 1240.0000 - 1300.0000 MHz

Features

- TrunkTracker IV with Control-Channel Only scanning and I-Call monitoring:
Tracks voice traffic on P25, Motorola, EDACS, and LTR Trunked systems
- Supports scanning of Rebanded systems
- APCO25 Digital Audio decoding
- Support for P25 Conventional channels that include NAC and TGID user differentiation (P25 One-Frequency Trunk)

- Adaptive Digital Threshold - Automatically sets the digital decode threshold for APCO 25 systems
- EDACS ESK support
- Control Channel Data Output - allows the analysis of control channel data without the need to perform invasive modifications to the scanner
- Close Call RF Capture
- Close Call Temporary Store (last 10 hits)
- GPS Support for location-based scanning, location alerts, and crows-flight navigation*
- Independent GPS Control of Sites and Channel Groups*
- Supported step sizes: 5, 6.25, 7.5, 8.33, 10, 12.5,15, 20, 25, 50 or 100 kHz
- Fire Tone Out Alert
- Fire Tone Out Search - built-in frequency counter displays the received tones.
- Band Scope - gives a graphic representation of signal activity.
- Multi-color display backlight
- Multi-Site support
- DCS/CTCSS Rapid Decode
- NAC decoding
- Ability to flag a channel as Digital, Analog, or All
- Temporary Lockout
- 10 Startup Configurations
- System / Channel Number Tagging - provides rapid access to a specific system or channel.
- Scan and (selected) Service Search simultaneously
- Frequency/ID AutoStore? - automatically store frequencies from a service or limit search into a conventional system or store talk group IDs into a trunked system
- 16 character text tagging for each system, group, channel, talkgroup, search range, and SAME group
- Compatible with BC-RH96 Remote Head
- Analog and Digital AGC
- Quick Search
- Individual channel volume offset
- Intermediate Frequency Exchange - changes the IF used for a selected frequency to help avoid image and other mixer-product interference on a frequency.
- Key Safe Mode - lets you hand the scanner to a novice user and prevent programming from being modified.
- Private Systems - lets you flag a system so that it cannot be read out of the scanner or modified.
- 12 Service Searches - Public Safety, News, HAM Radio, Marine, Railroad, Air, CB Radio, FRS/GMRS, Racing, FM Broadcast, and Special (Itinerant)

- Custom Search - lets you program up to 10 search ranges
- SAME Weather Alert
- Weather Priority
- Priority Scan with Priority Plus
- Priority ID Scan on trunked systems
- Preemptive Priority on Motorola analog systems
- Quick-Access Search Keys
- Negative Channel dropout delay (forced resume)
- Signal Strength display
- Battery level display
- LCD and Keypad Backlight
- Adjustable scan delay
- Adjustable Hold (0-255 sec) per system, custom or service search
- Strong signal attenuation
- Upgradeable firmware
- Channel Alert (both tones and backlight color)
- Independent Alert Tone Volume - lets you set the volume level of the following tones: Key Beep, Emergency Alert, Channel Alert, and Close Call Alert.
- Repeater Reverse
- Broadcast signal ignore while searching (TV and radio station frequencies, pagers, etc)
- Duplicate Channel Alert
- Key Lock
- PC Programming and Control
- Wired Cloning
- Record Output
- Automatic backlight level detection (when used with the "Orange" wire connected to a headlight switched power lead)
- DIN / ISO In-Dash Mounting with included DIN-E sleeve.

BCD996XT Specs

To determine whether the information on this page applies to your scanner, see the tags at the bottom of the page.

- Certified in accordance with FCC Rules and Regulations Part 15 Subpart C as of date of manufacture. (See [FCC Information](#) for more details.)
- FCC ID: AMWUB360
- [BCD996XT Specs](#)
 - [General](#)
 - [Frequency Range](#)
 - [Special Functions](#)
 - [Band Scope Function](#)
 - [Two-Tone-Sequential](#)
 - [WX Alert](#)
 - [Supported trunking systems](#)
 - [Dynamic memory allocation capacity](#)
 - [Heterodyne System](#)
 - [CTCSS and DCS Tones](#)

General

Attenuation	20dB nominal
Audio Output Power	3W nominal into 8 Ω speaker
	30mW nominal into 32 Ω stereo headphone
Scan Rate	100 channels per second max (Conventional mode)
Search Rate	300 steps per second max (5kHz steps only)
External Jacks	Antenna Jack: BNC Type

	Phone Jack: 3.5mm (1/8 in.) Stereo Type
	Ext.SP Jack: 3.5mm (1/8 in.) Monaural Type
	REC.Out Jack: 3.5mm (1/8 in.) Stereo Type
	Ext. DC Power and Orange Wire Jack 3 pin (Center Orange Wire)
	DC Power Jack: 5.5mm (1/5 in.) (Center Positive)
	GPS/Remote Interface Jack: D Sub 9pin Male Type
	Remote Interfase Jack (front panel): 4-pin Mini Custom Type
Internal Speaker	8.0Ω 5.0W Max. 77mm (3.0 in.)
Power Requirements	DC:11V to 16.6V(Ext.DC Power Jack or DC Power Jack)
	AC Adapter (13.8V DC 750mA Regulated) (AD-1009)
Operating Temperature	Nominal: -20°C to +60°C -4°F to +140°F
	Close Call: -10°C to +60°C +14°F to +140°F
Size	7.2 in.(W) x 5.9 in.(D) x 2.2 in.(H)
Weight	3.44 lbs
Remote Functions	Direct PC control
	Database management
	Wired cloning
Display	64 x 128 Full Dot Matrix LCD with multi-color back light

Sensitivity (nominal) 12dB SINAD		
0.3•V	25-27.995 MHz	AM
0.3•V	28-53.98 MHz	NFM
0.5•V	54-71.95 MHz	WFM
0.2•V	72-75.995 MHz	FM
0.5•V	76-107.9 MHz	FMB
0.3•V	108-136.9916 MHz	AM
0.2•V	137-173.9875 MHz	NFM
0.5•V	174-215.95 MHz	WFM
0.3•V	216-224.98 MHz	NFM
0.3•V	225-379.975 MHz	AM
0.3•V	380-512 MHz	NFM
0.3•V	758-960 MHz	NFM
0.4•V	1240-1300 MHz	NFM

Signal Noise Ratio (nominal)		
49dB	25-27.995 MHz	AM
41dB	28-53.98 MHz	NFM

54dB	54-71.95 MHz	WFM
48dB	72-75.995 MHz	FM
60dB	76-107.9 MHz	FMB
50dB	108-136.9916 MHz	AM
41dB	137-173.9875 MHz	NFM
54dB	174-215.95 MHz	WFM
41dB	216-224.98 MHz	NFM
50dB	225-379.975 MHz	AM
40dB	380-512 MHz	NFM
41dB	758-960 MHz	NFM
37dB	1240-1300 MHz	NFM

Close Call Sensitivity (nominal)	
140•V	VHF Low1 Band
100•V	VHF Low2 Band
80•V	Air Band
80•V	VHF High1 Band
90•V	VHF High2 Band

110•V	UHF Band
180•V	800MHz+ Band

Frequency Range

<u>Frequency Range</u> (MHz)	<u>Modulation</u>	<u>Step</u> (kHz)	<u>Name</u>
25.0000-26.9600	AM	5	Petroleum Products & Broadcast Pickup
26.9650-27.4050	AM	5	CB Class D Channel
27.4100-27.9950	AM	5	Business & Forest Products
28.0000-29.6800	NFM	20	10 Meter Amateur Band
29.7000-49.9900	NFM	10	VHF Low Band
50.0000-53.9800	NFM	20	6 Meter Amateur Band
54.0000-71.9500	WFM	50	VHF TV
72.0000-75.9950	FM	5	Intersystem & Astronomy
76.0000-87.9500	WFM	50	VHF TV
88.0000-107.9000	FMB	100	FM Broadcast
108.0000-136.9916	AM	8.33	Aircraft Band
137.0000-143.9875	NFM	12.5	Military Land Mobile
144.0000-147.9950	NFM	5	2 Meter Amateur Band

148.0000-150.7875	NFM	12.5	Military Land Mobile
150.8000-161.9950	NFM	5	VHF High Band
162.0000-173.9875	NFM	12.5	Federal Government
174.0000-215.9500	WFM	50	VHF TV
216.0000-224.9800	NFM	20	1.25 Meter Amateur Band
225.0000-379.9750	AM	25	Military Aircraft Band
380.0000-399.9875	NFM	12.5	Military Land Mobile
400.0000-405.9875	NFM	12.5	Miscellaneous
406.0000-419.9875	NFM	12.5	Federal Government Land Mobile
420.0000-449.9875	NFM	12.5	70 cm Amateur Band
450.0000-469.9875	NFM	12.5	UHF Standard Band
470.0000-512.0000	NFM	12.5	UHF TV
758.0000-775.99375	NFM	6.25	Public Service Band
788.0000-805.99375	NFM	6.25	Public Service Band
806.0000-823.9875	NFM	12.5	Public Service Band
849.0125-868.9875	NFM	12.5	Public Service Band
894.0125-960.0000	NFM	12.5	Public Service Band
1240.0000-1300.0000	NFM	25	25 cm Amateur Band

Special Functions

Band Scope Function

- Frequency Span 0.2 MHz To 500 MHz
- Frequency Step 5 kHz To 100 kHz

Two-Tone-Sequential

- 250.0-3500.0Hz , 0.1Hz Step Programmable

WX Alert

- 1050 Hz Tone System
- NWR-SAME System (Warning / Watch / Statement)

Supported trunking systems

- Motorola Systems: Type I, II, II/I (hybrid)
- EDACS Systems: FM, NFM, and SCAT
- LTR Systems
- APCO Systems: Astro Imbe, Astro 25

Dynamic memory allocation capacity

- Systems: 500 max
- Groups: 20 per system
- Site: 1000 max (All) 256 per system
- Channels: 25000 max (40128 memory blocks)
- Channels per Trunked System: 500 max

Heterodyne System

- 1st IF: 380.7 to 380.8 MHz / 265.5 to 265.6 MHz
- 2nd IF: 10.8 MHz
- 3rd IF: 450 kHz

CTCSS and DCS Tones

CTCSS Tone Frequencies - 50 frequencies total (Hz)									
67.0	69.3	71.9	74.4	77.0	79.7	82.5	85.4	88.5	91.5
94.8	97.4	100.0	103.5	107.2	110.9	114.8	118.8	123.0	127.3
131.8	136.5	141.3	146.2	151.4	156.7	159.8	162.2	165.5	167.9
171.3	173.8	177.3	179.9	183.5	186.2	189.9	192.8	196.6	199.5
203.5	206.5	210.7	218.1	225.7	229.1	233.6	241.8	250.3	254.1

DCS Tone Codes - 104 codes total							
023	025	026	031	032	036	043	047
051	053	054	065	071	072	073	074
114	115	116	122	125	131	132	134
143	145	152	155	156	162	165	172
174	205	212	223	225	226	243	244
245	246	251	252	255	261	263	265
266	271	274	306	311	315	325	331
332	343	346	351	356	364	365	371
411	412	413	423	431	432	445	446
452	454	455	462	464	465	466	503
506	516	523	526	532	546	565	606

612	624	627	631	632	654	662	664
703	712	723	731	732	734	743	754

This page applies to the following scanners: [BCD996XT Users Guide](#)

Available Operation Modes

To determine whether the information on this page applies to your scanner, see the tags at the bottom of the page.

The scanner has several different operation modes; in each mode, the scanner's operation, display, and key functions can be completely different:

- [Scan mode](#)
- [Search mode](#)
- [Hold mode](#)
- [Close Call Priority mode](#)
- [Close Call Only mode](#)
- [Close Call Do Not Disturb mode](#)
- [Priority Scan mode](#)
- [Priority Plus Scan mode](#)
- [GPS mode](#)
- [Weather mode](#)
- [Weather Priority Mode](#)
- [Weather Alert mode](#)
- [Tone Out mode](#)
- [Band Scope mode](#)

Scan mode

The scanner checks each frequency in the user-programmed list of frequencies. For trunked systems, it checks each Talk Group ID in the user-programmed list. When it detects a signal, the scanner stays on the channel and opens squelch. For trunked systems, if the Talk Group ID becomes active, the scanner switches to the audio channel and opens squelch. When the signal stops, the scanner continues the scan.

For information about key operation and other specifics about Scan Mode:

- [BCD396XT](#) and [BC346XT](#): [Hand Held Scanner Scan Mode](#)
- [BCD996XT](#): [BCD996XT Scan Mode](#)

- [BCT15X: BCT15X Scan Mode](#)

To enter Scan mode, tap **SCAN**. (This is the default mode when the scanner powers on.)

Search mode

The scanner checks each frequency that falls within a user-programmed range. For trunked systems, it checks each control channel in the user-programmed list. When it detects a signal, the scanner stays on the channel and opens squelch. For trunked systems, when it detects an active Talk Group ID, the scanner switches to the audio channel and opens squelch. When the signal stops, the scanner continues the search.

For information about key operation and other specifics about Scan Mode:

- [BCD396XT](#) and [BC346XT: Hand Held Scanner Search Mode](#)
- [BCD996XT: BCD996XT Search Mode](#)
- [BCT15X: BCT15X Search Mode](#)

To enter Search mode, **FUNCTION+** tap **SCAN** . The scanner asks if you want to perform the Quick Search: tap **YES** if this is the search you want. To start a different search, tap **NO**: the scanner takes you to the [Search for...](#) menu, and you can select your search.

Hold mode

The scanner stays on the current channel and enables save and edit options (options vary depending on the type of system).

For more information about key operation and other specifics about hold mode:

- [BCD396XT: BCD396XT Hold Mode](#)
- [BCD996XT: BCD996XT Hold Mode](#)
- [BC346XT: BC346XT Hold Mode](#)
- [BCT15X: BCT15X Hold Mode.](#)

To enter Hold mode, tap **HOLD**.

Close Call Priority mode

In Close Call Priority, the scanner interrupts its current operation every 2 seconds, searches for signals that are stronger than other signals on the selected band, then returns to the previous operation. When it detects a close call hit, the scanner can switch to the channel and open squelch (depending on the setting). In Close Call DND (do-not-disturb) mode, the scanner only interrupts if it is not already receiving audio.

For more information about key operation and other specifics about Close Call mode:

- [BCD396XT](#) or [BC346XT](#): [Handheld Scanner Close Call Mode](#)
- [BCD996XT](#): [BCD996XT Close Call Mode](#)
- [BCT15X](#): [BCT15X Close Call Mode](#)

To enter Close Call mode on the [BCD396XT](#) or [BC346XT](#), **FUNCTION** + repeatedly tap **HOLD** until Close Call Pri appears.

To enter Close Call mode on the [BCD996XT](#), repeatedly tap the **SQ** knob until Close Call Pri appears.

To enter Close Call mode on the [BCT15X](#), **Function** + repeatedly tap the **SQ** knob until Close Call Pri appears.

The Close Call icon appears for Close Call Priority mode and is in reverse colors for Close Call DND mode.

Close Call Only mode

The scanner stops the current operation and only performs Close Call checks as described above.

For more information about key operation and other specifics about Close Call Only mode:

- [BCD396XT](#) or [BC346XT](#): [Handheld Scanner Close Call Only Mode](#)
- [BCD996XT](#): [BCD996XT Close Call Only Mode](#)
- [BCT15X](#): [BCT15X Close Call Only Mode](#)

To enter Close Call only mode on the [BCD396XT](#) or [BC346XT](#), **FUNCTION** + press & hold **HOLD**.

To enter Close Call only mode on the [BCD996XT](#), press and hold the **SQ** knob.

To enter Close Call only mode on the [BCT15X](#), **FUNCTION** + press & hold the **SQ** knob.

Close Call Do Not Disturb mode

When set in this mode, the scanner will periodically make Close Call checks whenever the scanner is not receiving audio in another mode. This eliminates the annoying breaks in conversation while still allowing for the Close Call functionality. In Close Call Do Not Disturb mode, the Close Call icon appears in reversed color.

For more information about key operation and other specifics about Close Call Do Not Disturb mode:

- [BCD396XT](#) or [BC346XT](#): [Handheld Scanner Close Call Mode](#)
- [BCD996XT](#): [BCD996XT Close Call Mode](#)
- [BCT15X](#): [BCT15X Close Call Mode](#)

To enter Close Call Do Not Disturb mode on the [BCD396XT](#) or [BC346XT](#), **FUNCTION** + repeatedly press **HOLD** until Close Call DND appears

To enter Close Call Do Not Disturb mode on the [BCD996XT](#), repeatedly press the **SQ** knob until Close Call DND appears.

To enter Close Call Do Not Disturb mode on the [BCT15X](#), **FUNCTION** + repeatedly press the **SQ** knob until Close Call DND appears.

Priority Scan mode

At a specified interval, the scanner interrupts its current operation, checks the user-designated conventional priority channels, then resumes the previous operation. You can

set the interval for priority scan checks.

For more information about key operation and other specifics about Priority Scan mode, see [Priority Scan](#).

To enter Priority Scan mode on the [BCD396XT](#) or [BC346XT](#):

1. Enter Hold mode.
2. **FUNCTION** + tap **NO**.

To enter Priority Scan mode on the [BCD996XT](#), press **PRI**.

To enter Priority Scan mode on the [BCT15X](#), **FUNCTION** + press **POL/PRI**.

If no conventional channels in enabled and unlocked systems are designated as priority, the scanner will display *Priority Scan No Channel*.

For trunked priority channels, you need to enable priority scanning in the system option menu as well as tagging the channel as priority. Trunked priority only works while scanning that system's control channel or (in the case of Motorola systems) when the scanner is scanning any channel in the system.

Priority Plus Scan mode

The scanner stops the current operation and only performs Priority Scan checks as described above.

To enter Priority Plus Scan mode on the [BCD396XT](#) or [BC346XT](#):

1. Enter Hold mode.
2. **FUNCTION** + repeatedly tap **NO** until the scanner displays *Priority Mode Plus On*.

To enter Priority Plus Scan mode on the [BCD996XT](#), press **PRI** until the scanner displays *Priority Mode Plus On*.

To enter Priority Plus Scan mode on the [BCT15X](#), **FUNCTION** +

repeatedly tap **POL/PRI** until the scanner displays *Priority Mode Plus On*.

GPS mode

(Requires a connected GPS receiver.) The scanner displays longitude, latitude, and heading information.

For more information about key operation and other specifics about GPS mode:

- For the [BCD396XT](#) or [BC346XT](#): [Handheld GPS Mode](#)
- For the [BCD996XT](#): [BCD996XT GPS Mode](#)
- For the [BCT15X](#): [BCT15X GPS Mode](#)

To enter GPS mode on the [BCD396XT](#) or [BC346XT](#), **FUNCTION** + tap **GPS**.

To enter GPS mode on the [BCD996XT](#) or BCT15, tap **GPS**.

Weather mode

The scanner checks each of the 10 National Weather Radio channels and opens squelch when it detects a signal. When the signal stops, the scanner continues checking the other weather channels. For more information about Weather Mode, see [Weather Mode](#).

To enter Weather mode on the [BCD396XT](#) or [BC346XT](#), **FUNCTION** + press & hold **WX**.

To enter Weather mode on the [BCD996XT](#), press & hold **WX**.

To enter Weather mode on the [BCT15X](#), **FUNCTION** + press and hold **GPS/WX**.

Weather Priority Mode

In Weather Priority mode, the scanner interrupts scanning every 5 seconds to check for an alert. If an alert tone is present, the scanner sounds an alert tone, then stays on the weather channel so you can hear the alert. For more information about Weather Priority

Mode, see [Weather Mode](#).

To enter Weather Priority mode on the [BCD396XT](#) or [BC346XT](#),
FUNCTION + tap **WX**.

To enter Weather Priority mode on the [BCD996XT](#), tap **WX**.

To enter Weather Priority mode on the [BCT15X](#), **FUNCTION** + tap **GPS/**
WX.

Weather Alert mode

This is similar to Weather mode: the scanner checks each of the 10 National Weather Radio channels and stays on a channel when it detects a signal. However, in Weather Alert mode, the scanner only opens squelch if it detects the EAS alert tone. For more information about Weather Alert Mode, see [Weather Mode](#).

To enter Weather Alert mode on the [BCD396XT](#) or [BC346XT](#):

1. Enter Weather mode.
2. **FUNCTION**+ tap **WX**.

To enter Weather Alert mode on the [BCD996XT](#):

1. Enter Weather mode.
2. Tap **WX** .

To enter Weather Alert mode on the [BCT15X](#):

1. Enter Weather mode.
2. **FUNCTION** + tap **GPS/WX**.

Tone Out mode

The scanner checks up to 10 user-programmed channels for two-tone sequential, single, or group paging tones. When it detects a tone that matches the configuration for that channel, the scanner displays the tone information and opens squelch. For more

information about Tone Out Mode:

- [BCD396XT](#) or [BC346XT](#): [Hand Held Tone-Out Mode](#)
- [BCD996XT](#): [BCD996XT Tone-Out Mode](#)
- [BCT15X](#): [BCT15X Tone-Out Mode](#)

To enter Tone Out mode, tap **MENU** , then scroll down and select *Tone-Out for...*

To exit Tone Out mode, enter Scan mode.

Band Scope mode

The scanner searches a frequency ranges and displays a visual representation of the signal level. For more information about Band Scope Mode:

- [BCD396XT](#) or [BC346XT](#): [Hand Held Band Scope Mode](#)
- [BCD996XT](#): [BCD996XT Band Scope Mode](#)
- [BCT15X](#): [BCT15X Band Scope Mode](#)

To enter Band Scope Mode:

1. Set one of the 3 search keys to a Band Scope search.
2. Enter Search mode.
3. Press & hold the designated search key.

This page applies to the following scanner(s): [BCD996XT](#) [BCT15X](#) [BCD396XT](#)
[BC346XT Users Guide](#)

Menu tree

BCD996XT main menu

- [Program System](#)
- [Program Location](#)
- [Srch/CloCall Opt](#)
- [Search for...](#)
- [Close Call](#)
- [Priority Scan](#)
- [WX Operation](#)
- [Tone-Out for...](#)
- [Wired Clone](#)
- [Settings](#)

Using the menu

- To open the menu, tap **MENU** .
- Turn the **Scroll/Function** knob to move the cursor and highlight menu items. The currently highlighted item appears in reversed-out text.
- To select the highlighted item or confirm an option setting, tap **E-YES** or press down on the **Scroll/Function** knob.
- To cancel an option setting, press **NO** .
- To go back one level in the menu, tap **MENU** .
- To exit the menu, press **LOCKOUT** . The scanner goes back to the operating mode it was in before you entered the menu.

This page applies to the following scanner(s): [BCD996XT Users Guide](#)

Keys and their functions

- [Key Overview](#)
- [Operating the controls](#)
 - [Using the FUNCTION button](#)
- [Key functions in different operation modes](#)

Key Overview

The diagram below shows the keys and what they are called throughout the guide:

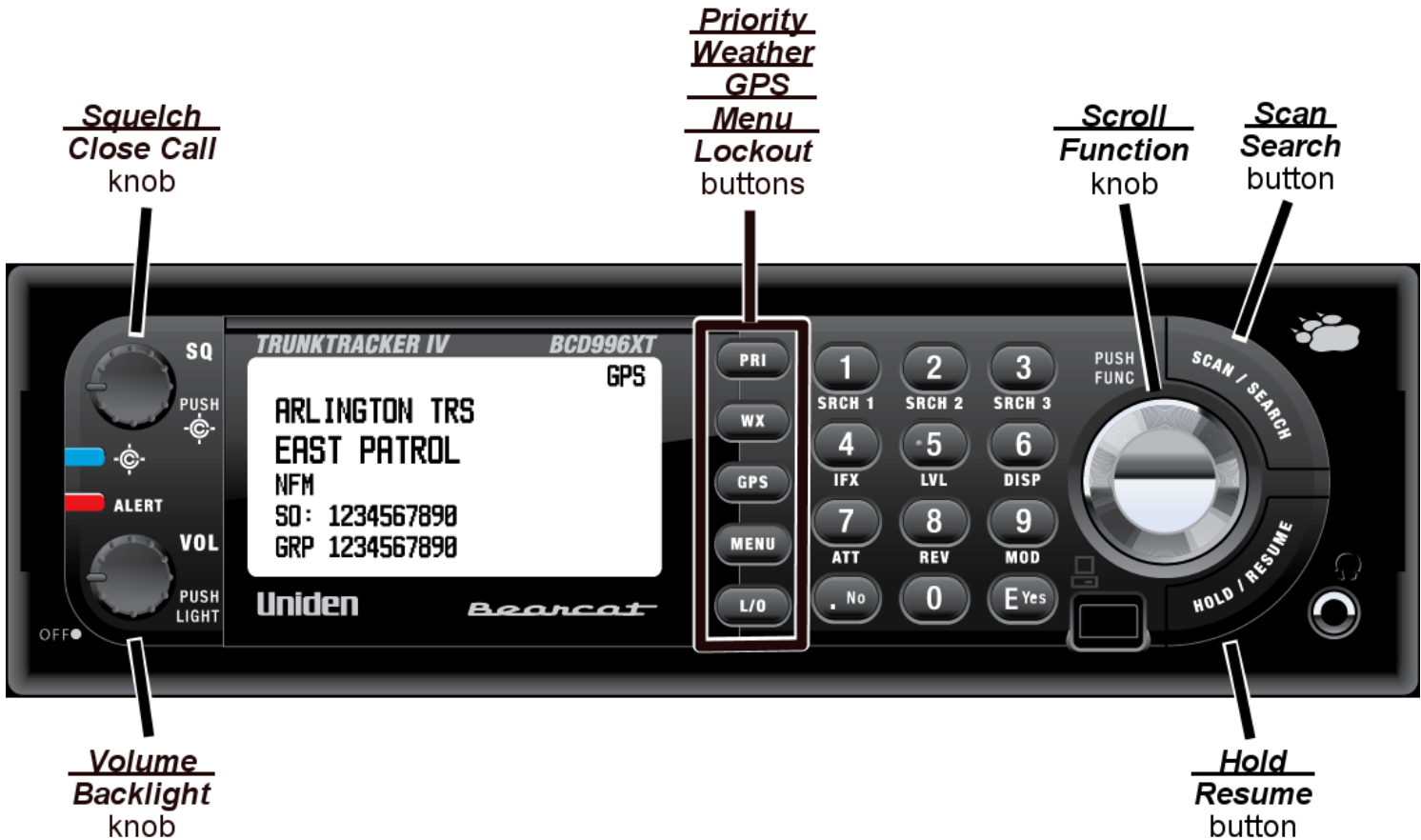

Operating the controls

Each button has at least two different actions which you control using the key combinations explained below.

- *Tap* : press the button and release it immediately
- *Double tap* : press the button twice, as quickly as possible (within 1 second)
- *Press & hold* : press the button and keep it pressed for at least 2 seconds before releasing it
- **FUNCTION + tap** : press and release **FUNCTION** , then tap the button
- **FUNCTION + Double tap** : press and release **FUNCTION** , then double tap the button
- **FUNCTION + Press & hold** : press and release **FUNCTION** , then press and hold the button

Using the FUNCTION button

When you tap FUNCTION (the scroll knob), the scanner remembers the **FUNCTION** + key combination for the next 3 seconds; during this time, it displays an *F* icon at the top of the screen.

If you want the scanner to maintain the **FUNCTION** + key combination longer, press & hold FUNCTION. The scanner remembers the **FUNCTION** + key combination until the next time you tap FUNCTION; during this time, it displays *Function Key Holding* and flashes the *F* icon at the top of the screen.

Key functions in different operation modes

The keys have different functions in each operation mode:

- [Scan and Search mode key functions](#)
- [Hold mode key functions](#)
- [Close Call mode key functions](#)
- [Priority Scan mode key functions](#)

- [GPS mode key functions](#)
- [Tone Out mode key functions](#)
- [Band Scope mode key functions](#)
- [Available functions in Key Safe mode](#)

This page applies to the following scanner(s): [BCD996XT Users Guide](#)

Reading the display

The display icons vary depending on the status of the scanner and what you're doing at any given time. The diagram shows common icon locations, and table below lists the most common icons and their meanings:

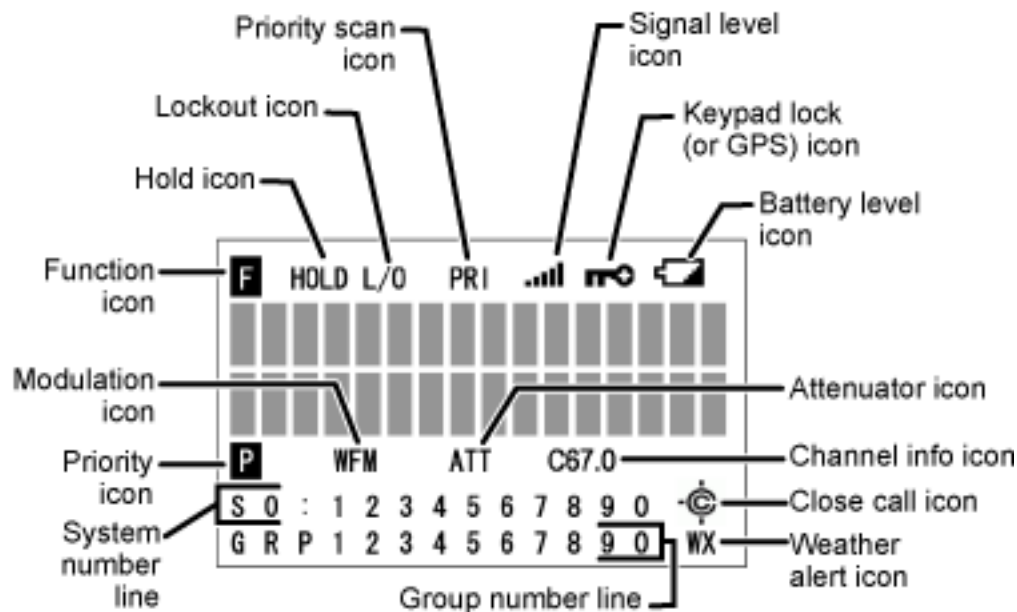

Attenuator icon	Steady: The attenuator is turned on for the current channel.
	Blinking: The attenuator is turned on globally (for all channels).
Battery level icon	x.xx: The remaining battery voltage is displayed in place of the Xs.
	Blinking icon: The battery is low. (If the AC adapter is connected while the icon is blinking, the battery is incorrectly installed, is the wrong type, or has gone bad.)

<p>Channel info icon</p>	<p>This icon has several available states:</p> <ul style="list-style-type: none"> ● P25: The received signal is digitized voice (APCO P25) ● LNK: The current channel is configured as a voice channel, but the scanner is receiving data on it. ● DAT: The current channel is configured as a control channel, and the scanner is receiving data on it. ● ENC: The received signal is encrypted P25 digitized voice, and the scanner has muted the audio. ● Cxx.x: The scanner has detected a CTCSS code; the received code is displayed in place of the Xs. ● DCSxxx: The scanner has detected a DCS code; the received code is displayed in place of the Xs. ● PNxxxx: The scanner has detected a P25 network address code (NAC); the received code is displayed in place of the Xs.
<p>Close call icon</p>	<p>Normal (open) icon:</p> <ul style="list-style-type: none"> ● Steady: Close call priority mode is on. ● Blinking: Close Call Only mode is on, or the scanner has detected a close call signal.
	<p>Reversed (filled) icon:</p> <ul style="list-style-type: none"> ● Steady: Close call DND mode is on. ● Blinking: Close call DND mode is on, and the scanner has detected a close call signal.

Function icon	Steady: You tapped the FUNCTION key; the scanner will remember the FUNCTION + key combination for the next 3 seconds.
	Blinking: You pressed & held the FUNCTION key; the scanner will remember the FUNCTION + key combination until you tap FUNCTION again.
Group number line (GRP)	In Scan mode: The group Quick Key numbers (GQK) of any unlocked groups in the current system or site are displayed on this line. The GQK number of the group that is currently being scanned blinks.
	In Hold mode: This line displays the GQK number of the current group only.
	In Custom Search mode: The numbers of any programmed search ranges are display on this line. The number of the custom range that is currently being searched blinks.
Hold icon	The scanner is in Hold mode.
IFX icon	You switched to the intermediate frequency (IF exchange).
Keypad lock (or GPS) icon	 : The keypad is locked.
	GPS: The scanner is receiving data from the GPS device.
Lockout icon	The current channel is locked out.
Modulation icon	This icon displays the modulation type of the current channel: AM, FM, NFM, FMB, or WFM.
Priority icon	The current channel is set as a priority channel.
Priority scan icon (PRI)	Steady: Priority scan is turned on.
	Blinking: Priority Plus scan is turned on.
REP icon	The Repeater Find feature is turned on.

Signal level icon	This icon displays the strength of the current signal; the icon ranges from zero bars (no signal) to five bars (strong signal).
System number line (Sx:)	In Scan mode: The system/site Quick Key numbers (SQK) of any unlocked systems or sites are displayed on this line. The SQK number of the system or site that is currently being scanned blinks. For SQK numbers above 9, the tens digit replaces the X in the icon; the ones digits are shown on this line.
	In Hold mode: This line displays the SQK number of the current system or site only. For SQK numbers above 9, the tens digit replaces the X in the icon; the ones digit is displayed on this line.
	In Service Search mode: The icon SCR replaces the System numbers if the broadcast screen feature is turned on.
Weather alert icon	Weather Alert Priority scan is turned on.

Special displays







In some operation modes, the display can be very different from the main display. These modes also have 2 or 3 different displays you can cycle through.

- [Band Scope mode display](#)
- [Hold mode displays](#)
- [GPS mode display](#)

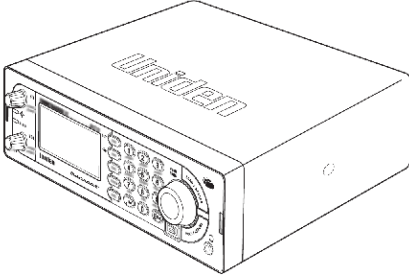
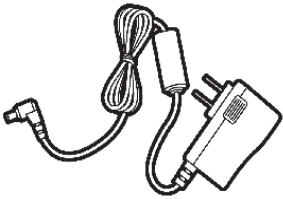
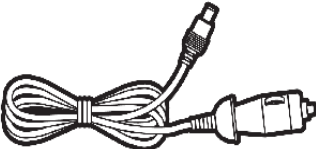
This page applies to the following scanner(s): [BCD996XT](#) [BCD396XT](#) [Users Guide](#)

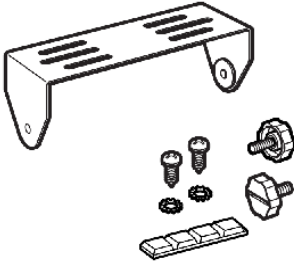
- [Included With Your Scanner](#)
- [Setting Up Your Scanner](#)
 - [Power Related Issues](#)
 - [Base Station](#)
 - [Setting Up an Audio Recording Device or Computer Recording](#)
 - [Vehicle Installation](#)
 - [Mounting Using the Bracket](#)
 - [Mounting Using the DIN-E Sleeve \(Option for BCT15X\)](#)
 - [Removing the Scanner from the DIN-E Sleeve](#)
 - [Mounting Using ISO Technique](#)
 - [Removing the Display Sticker](#)
 - [Connecting an Optional Antenna](#)
 - [Connecting an Earphone/Headphone](#)
 - [Connecting an Extension Speaker](#)

Included With Your Scanner

 <p>Scanner</p>	 <p>AC Adapter</p>	 <p>Vehicle Accessory Power Cord</p>
 <p>Three-Wire Harness</p>	 <p>Mounting Bracket and Hardware</p>	 <p>Antenna</p>
 <p>Serial Programming Cable</p>	 <p>O/M on CD ROM</p>	 <p>Other Printed Materials</p>

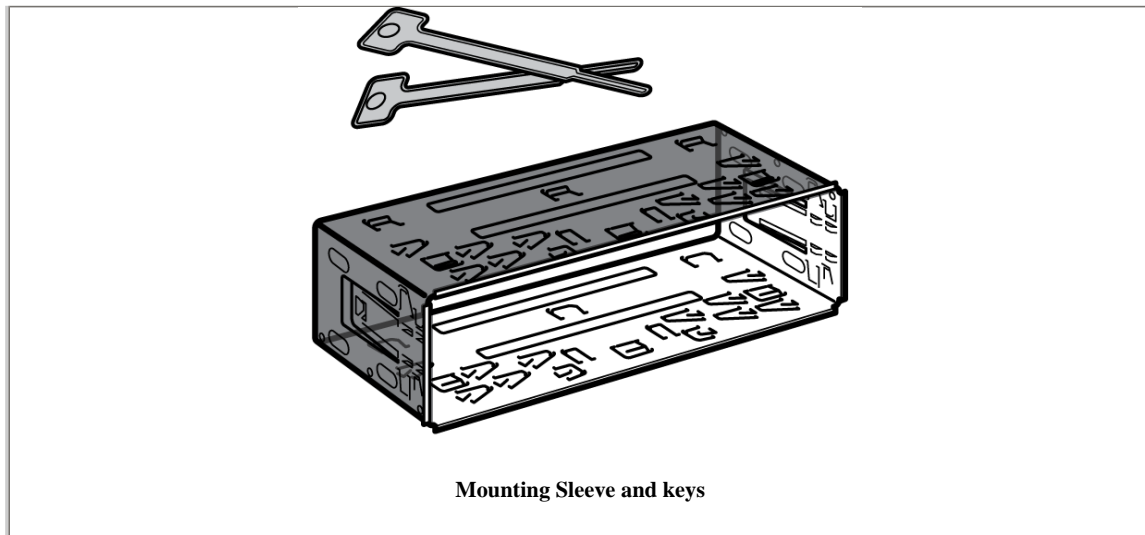

Setting Up Your Scanner

These guidelines will help you install and set up your new scanner:

The scanner can be placed on a convenient surface in your home as a base station, and connected to a standard outlet that supplies 120VAC, 60Hz. You must use either the supplied antenna or an electrically correct outdoor antenna, properly and safely mounted at your chosen site.

The scanner is also designed to accommodate either DIN-E and ISO-DIN automotive mounting configurations using a DIN-E sleeve and keys, (Part Number DIN-0001, BCT996XT? : Included; [BCT15X](#): Optional).

The unit can also be placed above, beneath, or in the dash of your vehicle using the supplied bracket and mounting hardware.

- If your scanner receives interference or electrical noise, move the scanner or its antenna away from the source.
- To improve the scanner's reception, use an optional external antenna designed for multi-band coverage. (You can purchase this type of antenna at a local electronics store). If the optional antenna has no cable, use 50Ω coaxial cable for lead-in. A mating plug might be necessary for the optional antennas.
- Use an optional stereo earphone or stereo headset with proper impedance (32 Ω) for private listening. Read the precautions at [General Precautions](#).
- Do not use the scanner in high-moisture environments such as the kitchen or bathroom.
- Avoid placing the scanner in direct sunlight or near heating elements or vents.

Power Related Issues

Important: To prevent memory from being corrupted, do not unplug the AC adapter during the time the memory is accessed for programming or auto store.

Notes:

- If when you connect the AC adapter the [VOL] /Power Switch is ON, the scanner may not power on. Should this occur, simply turn the control OFF, then ON again.
- If the scanner loses power (as when you turn off your car's ignition with the scanner's power switch on), it can lose some system settings such as display color and backlight. To ensure that such settings persist, either change the setting using the scanner's menu or power the scanner off then back on using the power switch after making such setting changes.

When you turn off the scanner using the power switch, the scanner remembers the last settings and mode. When you turn power back on, it resumes the previous mode.

Base Station

This is the simplest approach to let you get started quickly. Decide on a location that is convenient to a nearby wall outlet, has desk space to let you complete your programming worksheets, will safely allow the indoor antenna to be extended, or near a window to use an outdoor antenna.

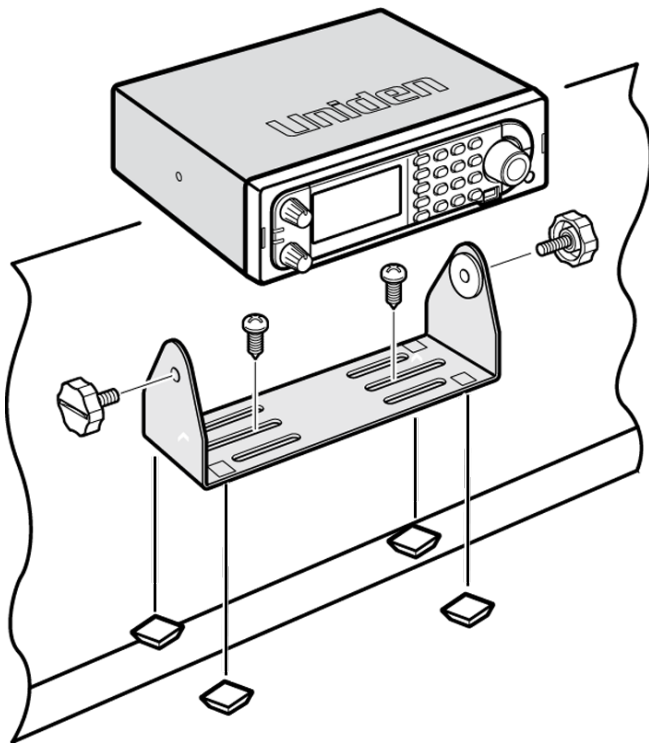

To secure the radio to a surface, by means of the mounting bracket, follow the steps below:

1. Attach the four protective mounting feet to the mounting bracket when you casually use the scanner on a flat surface. Should you desire to permanently mount the scanner, remove the feet and use wood screws through the bracket as described in Steps 2 and 3.
2. Use the bracket as a template to mark positions for the two mounting screws.
3. At the marked positions, drill holes slightly smaller than the screws.
4. Align the bracket with the threaded holes on the sides of the radio case so the bracket is beneath the radio. Secure the bracket using the two threaded knobs. Never overtighten the knobs.

Once the radio is positioned, connect it to a source of AC power using the supplied 13.8V, 750 mA AC adapter. Insert the barrel of the AC adapter to the jack on the rear, upper right side of the radio marked. Insert the connector of the supplied indoor telescoping antenna to the BNC Antenna Connector and apply moderate pressure to secure it.

Setting Up an Audio Recording Device or Computer Recording

It is best if you plan ahead when you initiate the basic setup of the scanner if you include the components to record incoming reception. You need an audio recording device which can be controlled by a Voice Operated module (VOX) either externally or from within the unit and the correct connecting cable. The REC (record) jack on the rear apron provides a constant-level audio output which is not affected by the setting of the volume control. Use a mono or stereo cable that ends in a 3.5mm plug for the scanner. The recorder might have its own requirements as to the proper plug. Check the recorder's instructions to be sure. Connect the cable to an external or internal VOX control so that the recorder operates when audio is present.

You can also connect the cable to the appropriate input jack on your PC so that with controlling software, you can record to your hard disk.

In order for the function to operate, you must set the channel to record. You must also set the system's record option to either All Channel, which will record all channels regardless of any channel's setting, or Marked Channel which only lets recording occur if you have selected record for that channel. Which you choose will depend on various factors.

Vehicle Installation

You can mount your scanner in your vehicle, using either the supplied bracket or the optional DIN-E sleeve.

Mounting Using the Bracket

With the bracket removed from the radio, use the holes in the bracket as a template to initially mark the location you plan to use in your vehicle. Be absolutely certain of what might be behind the mounting surface before making any holes, be it above, or below, or in front of your dash, armrest console, or other location. If you drill carelessly, expensive damage can result. If in doubt, consult your vehicle dealer's service department or a qualified professional installer.

Important: AVOID AIRBAG DEPLOYMENT ZONES. Ignoring this installation concern may result in bodily harm and the inability of the airbag to perform properly.

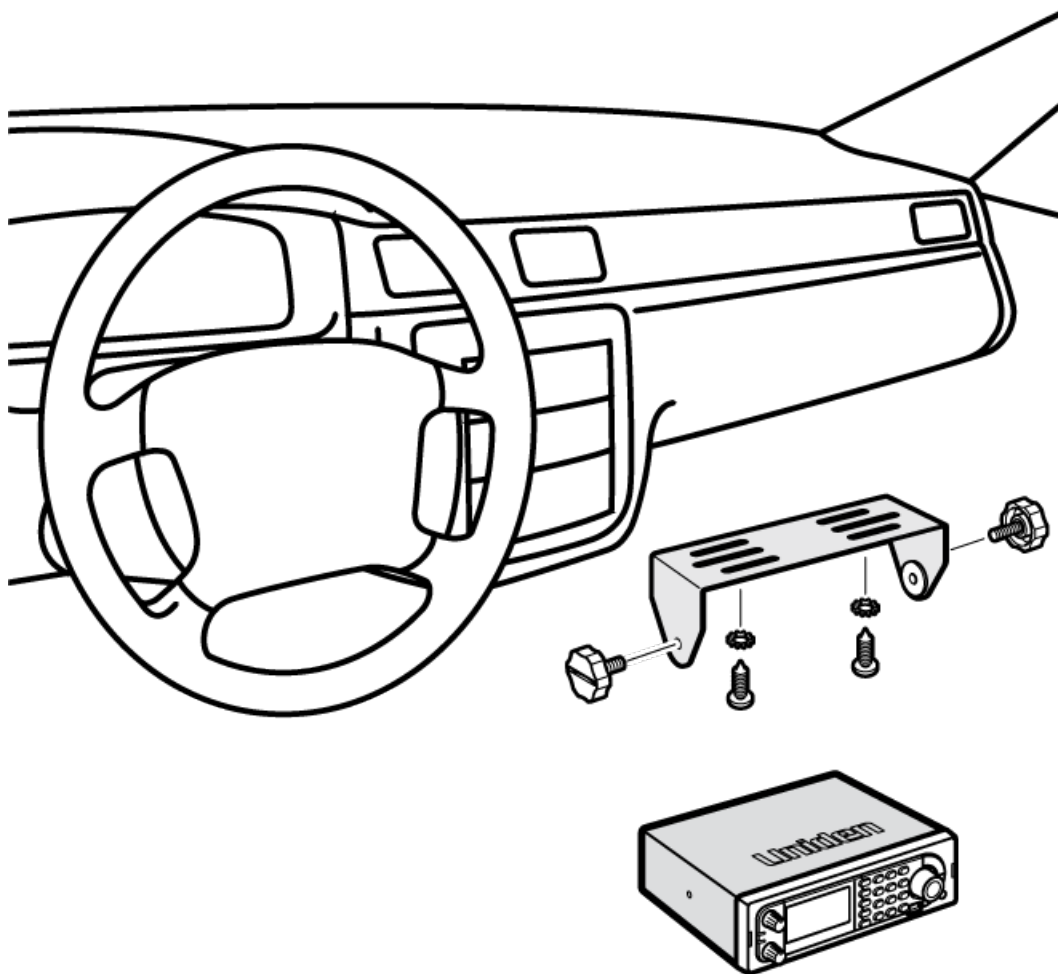

1. Using appropriate screws or other hardware, secure the bracket.
2. Insert the scanner and insert the bracket knobs to lock the scanner in position.
3. Attach the Cigarette Lighter Power Cord to the rear of the scanner and plug the adapter end into a dash mounted 12V DC socket.
4. Attach a suitable mounted mobile antenna to the antenna jack on the back of the scanner.

Mounting Using the DIN-E Sleeve (Option for [BCT15X](#))

If you are unsure about how to install your scanner in your vehicle using the optional DIN-E sleeve, consult your automobile manufacturer, dealer, or a qualified installer. Before installing, confirm that your scanner fits in the desired mounting area and you have all the necessary materials to complete the task. Your scanner requires a 2 x 7-1/8 x 5-5/16 inch (50 x 180 x 135 mm) mounting area. Allow an additional 2-3/8 inch (60mm) space behind the unit for connectors and wires.

To purchase the DIN-E sleeve and included Removal Keys, visit <http://www.unidendirect.com/> and order part number, DIN-0001.

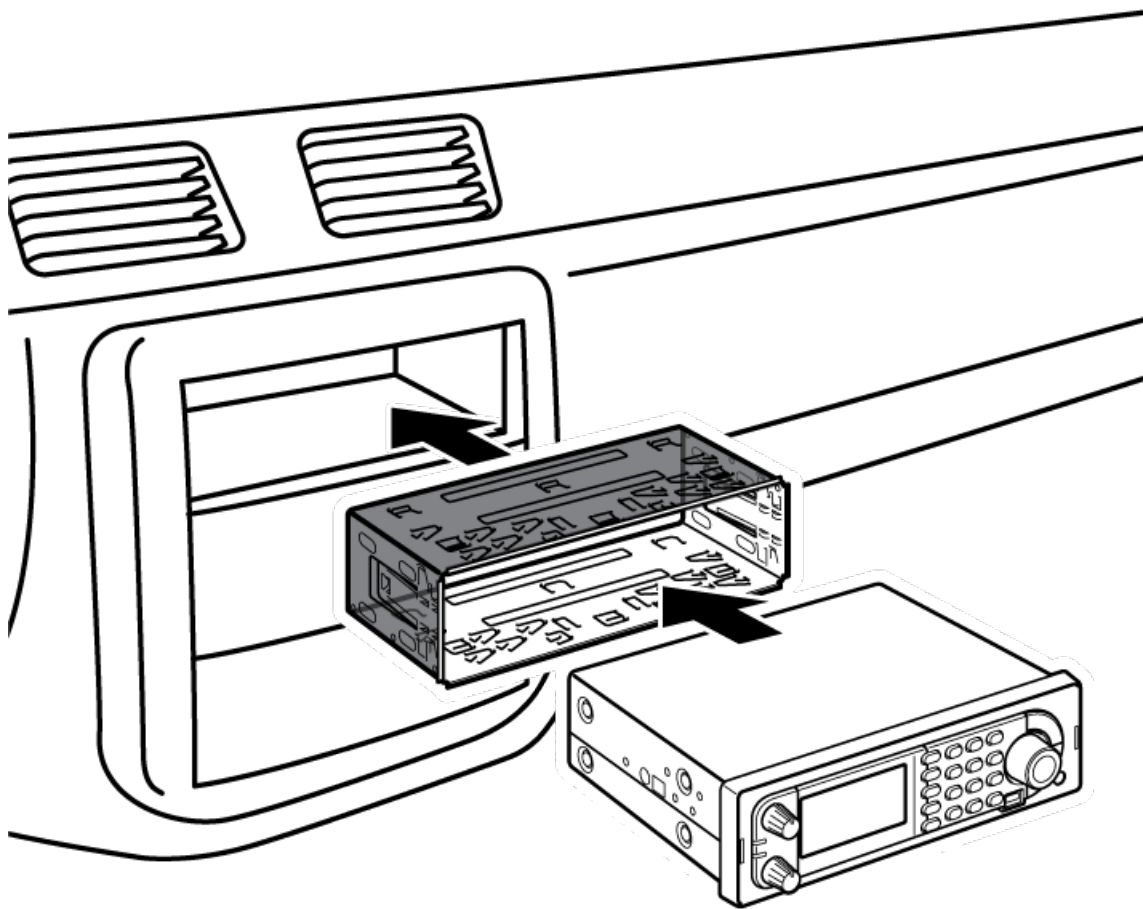

1. Remove the bracket if it is attached.
2. Remove the four Philips screws from four small tabs on the rear of the case that secure the outer metal case and pull off the case (toward the rear) with care.
3. Install the DIN sleeve into the opening in your dashboard, lip facing out.
4. Push out the top and bottom tabs to hold the sleeve firmly in place.
5. Before inserting the scanner in the sleeve, attach the cable from the previously mounted antenna. Attach the DC Power leads. RED goes to a positive (+) connection on your fuse block while BLACK connects to the vehicle's chassis ground (-).
6. Connect the ORANGE lead to one side of the headlamp switch so that when you activate the headlights, the scanner's LCD display changes intensity. Be sure all the connections are routed away from any potentially pinching or slicing sheet metal.
7. Slowly slide the scanner into the sleeve until it locks in place.
8. To remove the unit, fully insert the removal keys into each slot on the left and right edges of the front panel. Carefully slide the radio from the sleeve.

Note: If you plan to connect a GPS unit or external speaker at a later time, expect to remove the unit for ease of making those connections.

Removing the Scanner from the DIN-E Sleeve

If you plan to connect other devices or wires to the radio, such as a GPS unit, at a later time, you should plan to remove the scanner from the DIN-E sleeve. This is easily done using the provided Removal Keys that come with the optional DIN-E sleeve.

Refer to the illustration that follows, showing the Removal Keys.

Fully insert both Removal Keys into the slots on the left and the right edges of the radio's dress panel. You cannot remove the radio with only one key. Press in fully, and do not twist the keys. The radio will unlock from the sleeve making withdrawal from the sleeve possible. Store the keys in a safe place for future use.

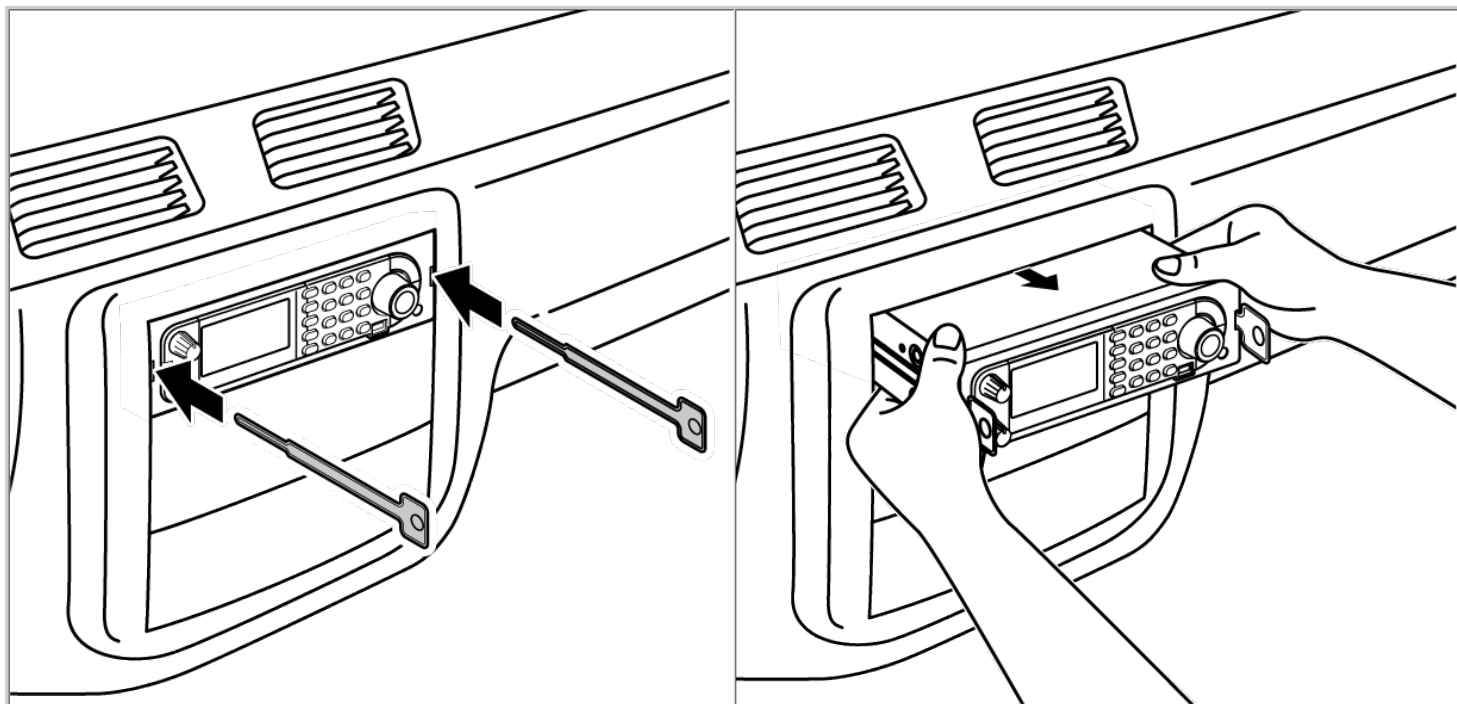

Mounting Using ISO Technique

Some vehicles can take advantage of another approach to mounting a radio in a vehicle, called the ISO technique. However, this technique requires a very detailed and thorough knowledge of the technique. Therefore, we strongly suggest that if you have any doubt about your experience and abilities, please consult with a professional installer who is familiar with the ISO approach to radio installation.

To begin the process, it is first necessary to remove the scanner's outer metal sleeve from the inner chassis. Unthread the four screws in the rear of the unit. Slide the cover toward the rear and off. Once the sleeve is removed, you will see threaded, metric machine screw holes on either side of the chassis cabinet. Uniden does not supply these screws. Their diameter, length, and screw type should be chosen by a qualified installer based on the internal vehicle bracket which will be used in securing the scanner chassis.

Once the original radio is removed from the vehicle dash and the fit of the scanner is correct, be sure to connect all the power, audio, antenna, and any other cables or wires, to the scanner before the scanner is secured.

The following illustration is a typical example of the ISO technique and the general side mounting screw holes often encountered. It does not actually represent the Uniden scanner nor your vehicle's mounting bracket. Only a professional installer will be able to determine the best and correct approach.

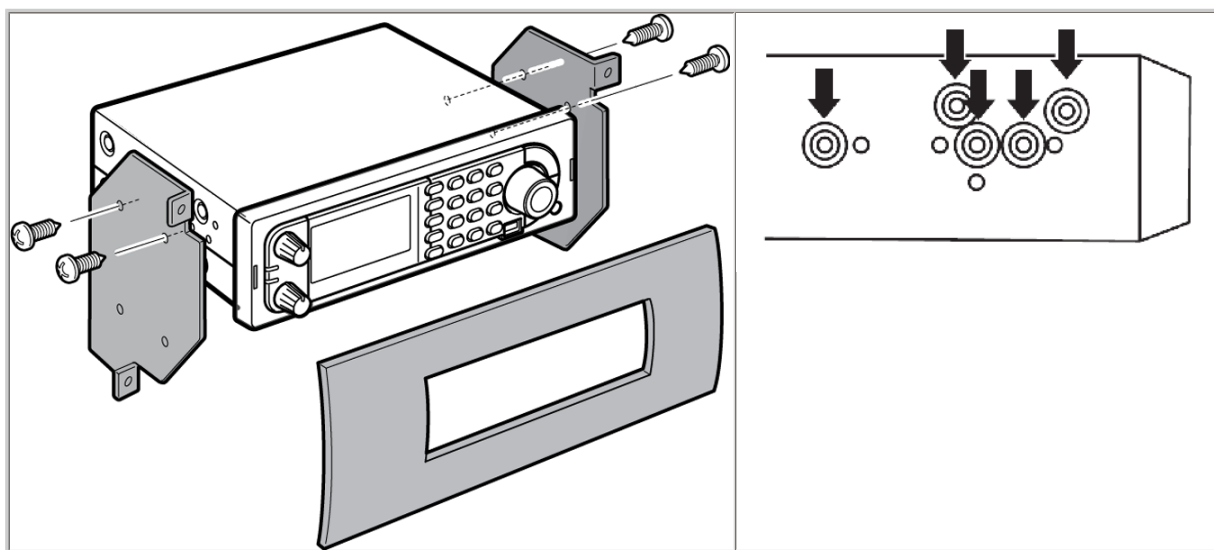

Removing the Display Sticker

Before you use the scanner for the first time, remove the protective plastic film over the display.

Connecting an Optional Antenna

The scanner's BNC connector makes it easy to connect a variety of optional antennas, including an external mobile antenna or outdoor base station antenna.

Note: Always use 50-ohm, RG-58, or RG-8, BNC terminated coaxial cable to connect an outdoor antenna. If the antenna is over 50 feet from the scanner, use RG-8 low-loss dielectric coaxial cable. Cable loss increases with higher frequency.

Connecting an Earphone/Headphone

For private listening, you can plug a 1/8-inch (3.5 mm) mini-plug earphone or headphones (not supplied) into the headphone jack on the front of your scanner. This automatically disconnects the internal speaker. See the [Earphone Warning](#) for important information about using an earphone/headphone.

WARNING!

Never connect anything other than the recommended amplified extension speaker to the scanner's headphone jack. Damage to the scanner might occur.

Connecting an Extension Speaker

In a noisy area, an optional amplified extension speaker, positioned in the right place, might provide more comfortable listening. Plug the speaker cable's 1/8-inch (3.5-mm) mini-plug into your scanner's back-panel Ext. Sp. Jack.

WARNING!

Never connect any part of the headphone jack to the antenna jack or connect the radio to an installation where the antenna and audio connection are grounded. This might also damage the scanner.

This page applies to the following scanner(s): [BCD996XT BCT15X Users Guide](#)

Connecting a GPS receiver

To determine whether the information on this page applies to your scanner, see the tags at the bottom of the page.

- [Compatible GPS receivers](#)
- [Configuring your scanner](#)
- [Connecting the receiver](#)
- [Troubleshooting](#)

Compatible GPS receivers

You can connect your scanner to any GPS receiver that meets the following criteria:

- Outputs NMEA-0183 v3.01-compliant location data
- Outputs both the Global Positioning System Fix (*GGA*) and Recommended Minimum Specific GNSS (*RMC*) data sentences
- Provides a serial data (RS-232) connection

Configuring your scanner

1. Go to the [Settings](#) menu and select *Set Serial Port* .
2. Select *_Set Baud Rate|*.
3. Select *Set Rear Port*.
4. Select *4800* bps for the baud rate.

Connecting the receiver



1. Plug your GPS receiver's RS232 cable directly into the DB9 connector on the back of the scanner.
2. When the scanner recognizes the GPS input, it displays a confirmation message and shows the GPS icon on the display.
3. If the GPS receiver does not have a lock on the satellites, the scanner displays *Searching for Satellite* .

Troubleshooting

If you can't get the scanner to recognize the GPS receiver:

- Check the receiver's baud rate. Most compatible GPS receivers use a baud rate of 4800 bps, but it's possible your receiver is using a non-standard baud rate. Set the scanner's baud rate to match the GPS receiver's.
- Check the receiver's output mode. Some receivers have proprietary signalling modes that are not NMEA compliant, but you can usually set them to use a NMEA compliant mode.

If the scanner recognizes the GPS receiver but doesn't lockout systems as you expected:

- Make sure the GPS receiver has a lock on the satellites.
- Check the location configuration for the sites and channel groups in the system.
 1. For each site or channel group, go to the [Set LocationInfo](#) menu.

2. Check the range, latitude, and longitude settings to make sure they are correct.
3. Make sure the *Set GPS Enable* option is set to *Yes* .

This page applies to the following scanner(s): [BCD996XT](#) [BCT15X](#) [Users Guide](#)

Number Tags

- Number Tags let you quickly navigate to a specific system or channel.
- You can assign Number Tags at the system level (*System Number Tag* , or *SNT*), at the channel level (*CHannel Number Tag* , or *CHNT*), or at both levels.
- You can assign an SNT to the temporary system *Close Call Hits* that is created during [Close Call](#) searches. This system and its SNT operate like any other system.
- You can assign Number Tags to service searches and custom search ranges. These search Number Tags operate like regular SNTs.
- [Programming Number Tags](#)
 - [Assigning an SNT](#)
 - [Assigning a CHNT](#)
- [Using Number Tags](#)

Programming Number Tags

Assigning an SNT

- SNTs can range from 0 to 999 .
- Systems can have the same SNT, but you will get a warning when you create multiples. (This includes SNTs assigned to the Close Call Hits system or any search ranges.)

To a system :

1. Open the [Program System](#) menu.
2. Select the system you want to assign the number tag to.
3. Select [Edit Sys Option](#), then select [Set Number Tag](#).
4. Enter the number tag you want to use for this system.

To the Close Call Hits system :

1. Open the [Close Call](#) menu.
2. Select [Hits with Scan](#), then select [Set Number Tag](#).

3. Enter the number tag you want to use for the Close Call Hits system.

To a service search range :

1. Open the [Search for...](#) menu.
2. Select [Edit Service](#), then select the service search range you want to assign the number tag to.
3. Select [Search with Scan](#), then select [Set Number Tag](#).
4. Enter the number tag you want to use for this search range.

To a custom search range :

1. Open the [Search for...](#) menu.
2. Select [Edit Custom](#), then select the custom search range you want to assign the number tag to.
3. Select [Search with Scan](#), then select [Set Number Tag](#).
4. Enter the number tag you want to use for this custom search range.

Assigning a CHNT

- You can assign CHNTs to channels even if the system does not have an assigned SNT. However, without an SNT, you can only navigate to these channels from within that system itself.
- CHNTs can be duplicated within their own system, but you will see a warning when you create multiples.
- CHNTs can range from 0 to 999 .

1. Open the [Program System](#) menu.
2. Select the system containing the channel you want to assign the number tag to.
3. Select [Edit Group](#), then select the channel group you want.
4. Select [Edit Channel](#), then select the channel you want to assign the number tag to.
5. Select [Set Number Tag](#).
6. Enter the number tag you want to use for this channel.

Using Number Tags

To navigate directly to:	Key Sequence	Example
A system or search range	<ol style="list-style-type: none"> 1. Tap HOLD. 2. Enter the SNT + •. 3. Tap MENU. 	If the SNT is 4 , enter HOLD / 4 / • / MENU .
A channel in the current system	<ol style="list-style-type: none"> 1. Tap HOLD. 2. Enter the CHNT. 3. Tap MENU. 	If the CHNT is 27, enter HOLD / 27 / MENU .
A channel in a different system	<ol style="list-style-type: none"> 1. Tap HOLD. 2. Enter the SNT <i>followed by the decimal point</i>. 3. Enter the CHNT. 4. Tap MENU. 	If the SNT is 4 and the CHNT is 27, enter HOLD / 4 / • / 27 / MENU .

Notes:

- If two systems have the same SNT, they will be selected in sequence (i.e. the first time you select the SNT, the scanner will go to the first system assigned with that SNT; if you select the same SNT again, it will go to the 2nd system assigned with that SNT, and so on).
- If two channels in the same system have the same CHNT, they will be selected in sequence (i.e. the first time you select the CHNT, the scanner will go to the first channel in that system assigned with that CHNT; if you select the same CHNT again, it will go to the 2nd channel assigned with that CHNT, and so on).

This page applies to the following scanner(s): [BCD996XT](#) [BCT15X](#) [BCD396XT](#) [BC346XT](#) [Users Guide](#)

Quick Keys

- Quick Keys let you enable or disable systems and channel groups during a scan. Disabled systems and channel groups are ignored during scans.
- You can assign Quick Keys at the system/site level (*System/site Quick Key* , or *SQK*), at the channel group level (*Group Quick Key* , or *GQK*), or at both levels.
- You can assign an SQK to the temporary system *Close Call Hits* that is created during [Close Call](#) searches. This system and its SQK operate like any other system.
- You can assign Quick Keys to service searches and custom search ranges. These search Quick Keys operate like regular SQKs.
- [Programming Quick Keys](#)
 - [Assigning an SQK](#)
 - [Assigning a GQK](#)
- [Using Quick Keys](#)
 - [To use SQK 0 through 9](#)
 - [To use SQK 10 through 99](#)
 - [To use a GQK](#)

Programming Quick Keys

Assigning an SQK

- Multiple systems, sites, and search ranges can share the same SQK.
- All systems and sites assigned to the same SQK will be enabled (or disabled) when you enter the Quick Key.
- SQKs range from 0 to 99 .

To a conventional system:

1. Open the [Program System](#) menu.
2. Select the system you want to assign the Quick Key to.
3. Select [Edit Sys Option](#), then select [Set Quick Key](#).
4. Enter the Quick Key you want to use for this system.

To a trunked system:

1. Open the [Program System](#) menu.
2. Select the system you want to assign the Quick Key to.
3. Select [Edit Site](#), then select the site you want.
4. Select [Set Quick Key](#), then enter the Quick Key you want to use for this site.

To the Close Call Hits system :

1. Open the [Close Call](#) menu.
2. Select [Hits with Scan](#), then select Set Quick Key? .
3. Enter the Quick Key you want to use for the Close Call Hits system.

To a service search range :

1. Open the [Search for...](#) menu.
2. Select [Edit Service](#), then select the service search range you want to assign the Quick Key to.
3. Select [Search with Scan](#), then select [Set Quick Key](#).
4. Enter the Quick Key you want to use for this search range.

To a custom search range :

1. Open the [Search for...](#) menu.
2. Select [Edit Custom](#), then select the custom search range you want to assign the Quick Key to.
3. Select [Search with Scan](#), then select [Set Quick Key](#).
4. Enter the Quick Key you want to use for this custom search range.

Assigning a GQK

- All channels in the channel group will be enabled (or disabled) when you enter the GQK.
- Multiple channel groups in the same system can share the same GQK. However, all of these channel groups will be enabled (or disabled) when you enter the GQK from within that system.
- You can assign GQKs to channel groups even if their system does not have an assigned SQK.

- You can only use GQKs within the current system: the GQK will not affect a channel group in another system.
 - GQKs range from 0 to 9 .
1. Open the [Program System](#) menu.
 2. Select the system containing the channel group you want to assign the Quick Key to.
 3. Select [Edit Group](#), then select the channel group you want.
 4. Select [Set Quick Key](#), then enter the Quick Key you want to use for this channel group.

Using Quick Keys

- Quick Keys only work in Scan mode.
- Entering the Quick Key toggles the enabled/disabled state of the system/site/search range or channel group (i.e., if the system is currently enabled, entering the Quick Key will disable it, and vice-versa).

To use SQK 0 through 9

- Enter Scan mode.
- Tap the number key that matches the SQK. (For example, if the SQK is 4, just enter 4.)
- Any systems, sites, or search ranges assigned to this SQK become disabled. (If they were already disabled, they become enabled.)

To use SQK 10 through 99

- Enter Scan mode.
- Tap the decimal point (**.NO**), then enter the SQK. (For example, if the SQK is 32 , enter **.NO / 32.**)
- Any systems, sites, or search ranges assigned to this SQK become disabled. (If they were already disabled, they become enabled.)

To use a GQK

- Enter Scan mode.
- Go to the system that contains the channel group you want to enable or disable.

- Tap **FUNCTION** , then tap the number key that matches the GQK. (For example, if the GQK is 7 , enter **FUNCTION / 7**.)
- Any channel groups assigned to this SQK *within the current system only* become disabled. (If they were already disabled, they become enabled.)

This page applies to the following scanner(s): [BCD996XT](#) [BCT15X](#) [BCD396XT](#)
[BC346XT Users Guide](#)

Search Keys

The scanner has three Search Keys that you can assign to a special search range; the Search Keys are set to number keys **1** , **2** , and **3** :



Search Key 1



Search Key 2



Search Key 3

Programming Search Keys

1. Open the [Search for...](#) menu.
2. Select [Set Search Key](#), then select the search key you want to program.
3. Select the search range you want to assign to this Search Key. Choose one of the pre-programmed service search ranges, one of the 10 custom search ranges, a Tone-Out search, or a Band Scope search.

Using Search Keys

To start the search assigned to a Search Key, **FUNCTION** + tap that Search Key. For example, to start the search assigned to Search Key 2, **FUNCTION** + tap **2** .

(You can't use the Search Keys when the scanner is in Scan mode or GPS mode.)

If the Search Key you select starts a Tone-Out search, the scanner switches to Tone-Out mode and searches the most-recently-used Tone-Out channel (out of the 10 available). If you want to search a different Tone-Out channel, use the **SELECT-VOLUME-SQUELCH** knob on handheld models or the **SCROLL / FUNCTION** knob on mobile models to select the Tone-Out channel you want to use.

This page applies to the following scanner(s): [BCD996XT](#) [BCT15X](#) [BCD396XT](#)
[BC346XT](#) [Users Guide](#)

Programming locations

To use [Location-based Scanning](#) with a particular system, you will need to program your scanner with the geographic coordinates you want to use for each site or channel group. You can also program your scanner to alert you when you approach particular locations.

- [Programming a location for a site](#)
- [Programming a location for a channel group](#)
- [Programming general locations](#)
 - [To create a new location](#)
 - [For Dangerous Xing and Dangerous Roads only](#)
 - [Edit an existing location](#)

Programming a location for a site

Each system site can have separate location information.

1. Open the [Program System](#) menu.
2. Select the system you want to program for location based scanning.
3. Select [Edit Site](#), then select the first site you want to assign a location to.
4. Select the [Set LocationInfo](#) menu and enter the latitude, longitude, and range for this site.
5. Change the *Set GPS Enable* field to *On* .
6. Go back to the [Edit Site](#) menu and repeat these steps with any other sites you want to program for this system.

Programming a location for a channel group

Each channel group in a system can have separate location information.

1. Open the [Program System](#) menu.
2. Select the system you want to program for location based scanning.
3. Select [Edit Group](#), then select the first channel group you want to assign a location to.
4. Select the [Set LocationInfo](#) menu and enter the latitude, longitude, and range for this site.
5. Change the *Set GPS Enable* field to *On* .
6. Go back to the [Edit Group](#) menu and repeat these steps with any other sites you want to program for this system.

Remember: You have to turn on *Set GPS Enable* before the location information

can effect that site or channel group.

Programming general locations

You can program general locations (i.e., locations that are not associated with a site or channel group). There are three types of general locations:

- points of interest (*POI*)
- intersections (*Dangerous Xing*)
- roads (*Dangerous Road*)

You can program the scanner to alert you when you come within a designated distance of that location.

To create a new location

1. Open the [Program Location](#) menu.
2. Select the type of location you want to create.
3. Select *New Location* to create a new location of this type.
4. *If you want to create a different type of location, go back to the [Program Location](#) menu and select that location type.
5. If you want to change the default location name, select *Edit Name?* and enter a new name.
6. Select *Set LocationInfo?* and enter the latitude and longitude for this location.
7. Select *Set Range* and enter the distance from this location you want the scanner to alert you.
8. Choose the *Alert Tone* and *Alert Light* you want the scanner to use when you come within range of this location.

For Dangerous Xing and Dangerous Roads only

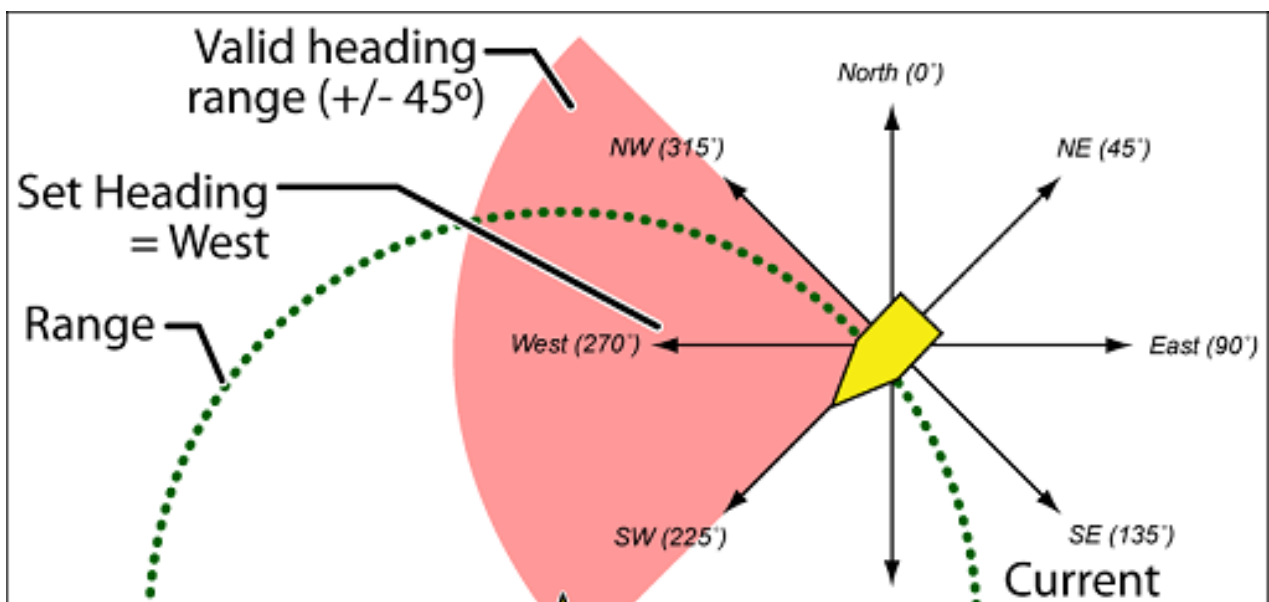

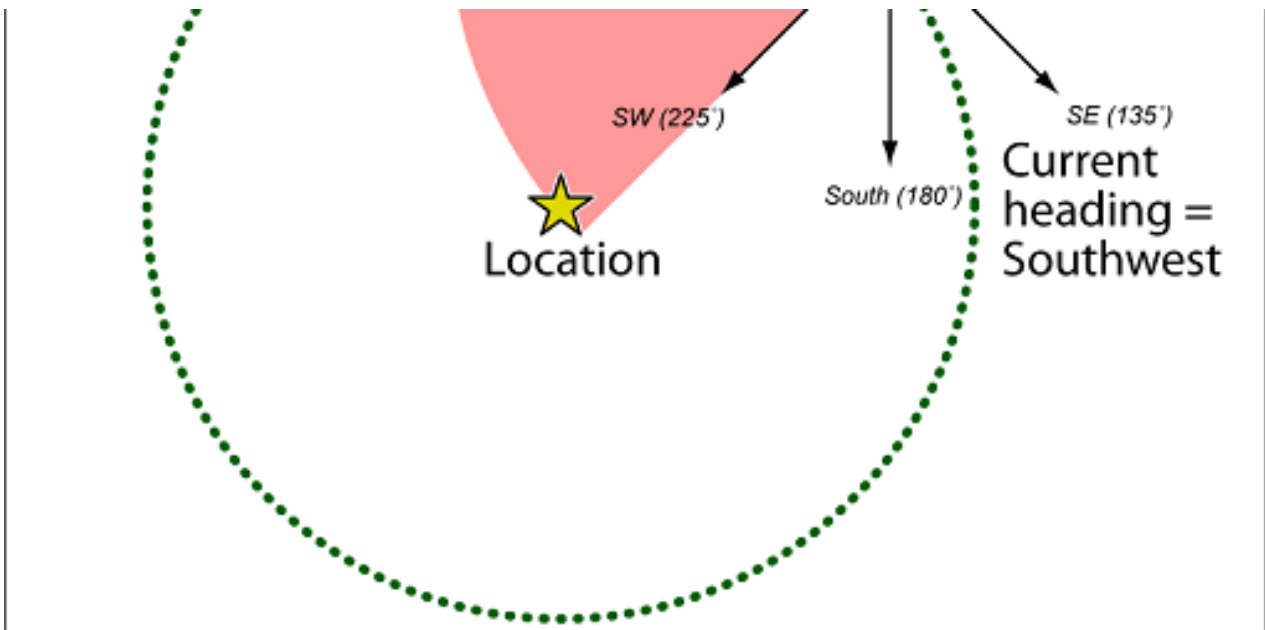

In addition to range, you can specify a heading and a speed limit for these types of locations:

- If you set a speed limit, the scanner will only trigger an alert when you are within the location's range *and* your current speed is over the programmed speed limit.
- If you set a heading, the scanner will only trigger an alert when you are within the location's range *and* your current heading is +/- 45 degrees from the programmed heading. (For example, if you set the heading as *North* , the scanner will trigger an alert if your current heading is *North-east* but not if your current heading is due *East* .)

Edit an existing location

1. Open the [Program Location](#) menu.
2. Select the type of location you want to edit; the scanner lists the existing locations of that type in alphabetical order.
3. Select the location you want to edit, then change any of the location settings you want.

This page applies to the following scanner(s): [BCD996XT](#) [BCT15X](#) [BCD396XT](#) [BC346XT](#)
[Users Guide](#)

Setting alerts

Your scanner can trigger alerts for several different events. The table below shows the different alerts and how to program them:

<u>To sound an alert when</u>	<u>Follow these steps</u>
A channel becomes active	Edit the channel properties (Edit Channel#Set Alert): <ol style="list-style-type: none"> 1. Go to the <i>Program System</i> menu and select the system that contains the channel you want set the alert for. 2. Select <i>Edit Group</i> , then select the group you want. 3. Select Edit Channel, then select the channel you want to set the alert for. 4. Select <i>Set Alert</i> . 5. Choose the <i>Alert Tone</i> and <i>Alert Light</i> you want the scanner to use.
An active Talk Group on a system contains an emergency flag	Edit the system properties (Edit Sys Option#Emergency Alert): <ol style="list-style-type: none"> 1. Go to the <i>Program System</i> menu and select the system you want set the alert for. 2. Select Edit Sys Option, then select <i>Emergency Alert</i> . 3. Choose the <i>Alert Tone</i> and <i>Alert Light</i> you want the scanner to use.

<p>The scanner detects a Close Call hit</p>	<p>Edit the Close Call properties:</p> <ol style="list-style-type: none"> 1. Go to the <i>Close Call</i> menu. 2. Select <i>Set CC Alert</i> . 3. Choose the <i>Alert Tone</i> and <i>Alert Light</i> you want the scanner to use. 4. For Close Call Alerts, you can also have the scanner pause before it resumes searching. Select <i>Set CC Pause</i> to activate this feature.
<p>The scanner gets a hit on a Tone-Out channel</p>	<p>Edit the Tone-Out channel properties:</p> <ol style="list-style-type: none"> 1. Go to the Tone-Out for... menu. 2. Select <i>Tone-Out Setup</i> , then select the Tone-Out channel you want to set the alert for. 3. Select <i>Set Alert</i> . 4. Choose the <i>Alert Tone</i> and <i>Alert Light</i> you want the scanner to use.
<p>You approach a particular location</p> <ul style="list-style-type: none"> ● Point of Interest(<i>POI</i>) ● Dangerous Road ● Dangerous Intersection (<i>Dangerous Xing</i>) 	<p>Edit the location properties:</p> <ol style="list-style-type: none"> 1. Go to the Program Location menu and select the type of location you want set the alert for. 2. Select the particular location. 3. For a POI, select <i>Set Alert</i> , then choose the Alert Tone and the Alert Light you want to use. 4. For a Dangerous Road or Xing, the alert tone is preset. Select the Alert Volume and the Alert Light you want to use.

NOTE: The scanner also triggers alerts for Weather Alerts ([WX Operation#Weather Alerts](#)), but you can't edit the alert tone and light.

This page applies to the following scanner(s): [BCD996XT](#) [BCT15X](#) [BC346XT](#)
[BCD396XT Users Guide](#)

Using Quick Keys, Startup Keys, and Search Keys

The different shortcut keys have different functions:

Quick Keys

- Quick keys let you enable and disable systems and channel groups (disabled systems and channel groups are ignored during scans).
- You must be in Scan mode to use Quick Keys.
- System Quick Keys (SQKs) let you enable or disable systems, sites or search ranges: just enter the SQK from the number pad.
- Group Quick Keys (GQKs) let you enable or disable channel groups inside the current system: Tap **FUNCTION** , then enter the GQK from the number pad.

Startup Keys

- Startup Keys let you lock and unlock several systems, sites, and search ranges all at the same time.
- When you activate a Startup Key, the scanner unlocks all systems, sites, and search ranges that are assigned to that same Startup Key; the scanner also locks all systems, sites, and search ranges that are assigned to a different Startup Key.
- To activate a Startup Key, press & hold the number key while you power the scanner on.

Search Keys

- Search Keys let you quickly start one of 3 programmed searches.
- To start the search assigned to a Search Key, **FUNCTION** + tap that Search Key.

This page applies to the following scanner(s): [BCD996XT](#) [BCT15X](#) [BCD396XT](#)
[BC346XT](#) [Users Guide](#)

Tone Out mode

To determine whether the information on this page applies to your scanner, see the tags at the bottom of the page.

With the tone out feature, the scanner monitors up to 10 different channels for paging tones (two-tone sequential, single tone, and group tone). Normally, the scanner monitors each of the 10 channels in turn. However, if any tone-out channels share the same frequency, modulator, and attenuator settings, the scanner checks these channels simultaneously.

Configuring Tone Out channels

To configure Tone-Out channels:

1. Press **FUNCTION** + **Squelch** knob.
2. Select the Tone-Out channel (*Tone-Out 1* through *Tone-Out 10*) you want to configure.
3. Press **E** to enter the configuration menu and set the properties as desired.

Required	Frequencies (Set Frequencies) Tone A and Tone B (Set Tones)
Recommended	Name (Edit Name)
Optional	Automatic Gain Control (Set Audio AGC) * Delay Time (Set Delay Time) Alert (Set Alert) Record Flag (Set Record)

**digital scanners only*

Using Tone-Out Mode











To start a Tone-Out search, tap **FUNCTION** + **Squelch** knob. The scanner starts searching the most recently-used Tone-Out channel (and any other Tone-Out Channels that have the same frequency, modulation, and attenuator settings).





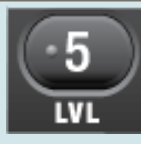
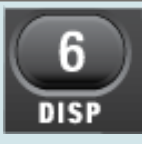



- If you want to search a different channel, just turn the **SCROLL** knob until you find the channel you



want.

- To exit Tone-Out mode, tap **SCAN**.
- To hear all transmissions on a tone-out frequency, even when a tone-out has not been activated, press **HOLD**. To return to Tone-Out Search mode, press **HOLD** again.

Key Operation in Tone Out Mode

Key Name (2nd operation)	 PRIORITY	 1 (Search 1)	 2 (Search 2)	 3 (Search 3)
Action On				
Tap	NA	Enter a digit in Direct Entry mode.		
FUNCTION + Tap	NA	Start the search range assigned to this Search Key.		
Key Name (2nd operation)	 Weather	 4 (IF exchange)	 5 (Level offset)	 6 (Display mode)
Action on:				
Tap	Toggle Weather Priority Mode	Enter a digit in Direct Entry mode.		
FUNCTION + Tap	Toggle Weather Priority Mode	Toggle the IF for that the current frequency.	NA	NA
Press & Hold	Go to Weather Scan mode.	NA	NA	NA
Key Name (2nd operation)	 GPS	 7 (Attenuation)	 8 (Reverse freq.)	 9 (Modulation)
Action on:				
Tap	Switch to the GPS Navigation display.	Enter a digit in Direct Entry mode.		
FUNCTION + Tap	Switch to the GPS Navigation display.	Toggle the attenuator state.	NA	Change the modulation.
FUNCTION + Press & hold	NA	Toggle the attenuator state for all signals.	NA	NA

Key Name (2nd operation) Action on:	 Menu	 ./ No (Decimal)	 0	 Yes (Enter)
Tap	Enter the Menu Mode.	Enter a decimal point or "i" in Direct Entry mode.	Enter a digit in Direct Entry mode.	Go to the configuration settings for the selected tone-out.
Function + Tap	Enter the Menu Mode at the "Tone-Out for..." menu.	NA		Go to the configuration settings for the selected tone-out.
Key Name (2nd operation) Action on:	 SQUELCH	 VOLUME	 SCAN/SEARCH	 HOLD/RESUME
Rotate	Adjust Squelch.	Adjust volume. Turn fully counterclockwise past click to turn off scanner.	NA	NA
Tap	Change Close Call mode.	Change backlight level.	Go to Scan mode.	Toggle Tone Out Hold mode.
Press & Hold	Go to Close Call Only mode.	NA	NA	NA
FUNCTION + Tap	NA	Toggle the P25 quality display.	Prompt to go to Quick Search mode.	Toggle Tone Out Hold mode.

Key Name (2nd operation) Action on:	 LOCKOUT	 SCROLL - FUNCTION
Rotate	NA	Select the Tone Out to use.
Tap	NA	Activate the FUNCTION mode for the next keypress.
Press & Hold	NA	Lock the FUNCTION mode.

This page applies to the following scanner(s): [BCD996XT UsersGuide](#)

Close Call Mode

To determine whether the information on this page applies to your scanner, see the tags at the bottom of the page.





When the scanner is in Close Call mode, it performs a close call check every 2 seconds. The scanner switches to the selected bands and searches for unusually strong signals (indicating the transmitter is probably somewhere close by). After the close call check, the scanner returns to its previous function.







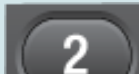
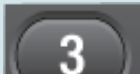

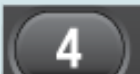
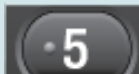
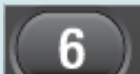
In *Close Call Do Not Disturb* mode, the scanner does not perform a Close Call check if it is already receiving an audio transmission. This prevents the audio from cutting out every 2 seconds.





In *Close Call Only* mode, the scanner only performs Close Call checks.



The [Close Call](#) menu lets you change the operation settings of the Close Call feature. You can change the overall Close Call options through the [Srch/CloCall Opt](#) menu.

Key Operation in Close Call Mode

Key Name (2nd operation)	 PRIORITY	 1 (Search 1)	 2 (Search 2)	 3 (Search 3)
Action On				
Tap	NA	Turn on/off the associated Close Call range.		
FUNCTION + Tap	NA	Start the search range assigned to this Search Key.		
When holding on a frequency	NA	Input the corresponding number in Direct Entry mode.		
Key Name (2nd operation)	 Weather	 4 (IF exchange)	 5 (Level offset)	 6 (Display mode)
Action on:				
Tap	Toggle Weather Priority Mode	Turn on/off the associated Close Call range.		

FUNCTION + Tap	Toggle Weather Priority Mode	When monitoring a frequency, toggle the IF for that frequency.	NA	NA
Press & Hold	Go to Weather Scan mode.	NA	NA	NA
When holding on a frequency	Toggle Weather Priority Mode.	Input the corresponding number in Direct Entry mode.		
Key Name (2nd operation) Action on:	 GPS	 7 (Attenuation)	 8 (Reverse freq.)	 9 (Modulation)
Tap	Switch to the GPS Navigation display.	Turn off the associated Close Call range.	NA	NA
Press & hold	NA	NA	NA	NA
FUNCTION + Tap	Switch to the GPS Navigation display.	Toggle the attenuator state.	NA	Change the modulation.
FUNCTION + Press & hold	NA	Toggle the attenuator state for all signals.	If stopped on a frequency that has a valid reverse (input) frequency, show the repeater reverse frequency for the current frequency (the scanner returns to the original frequency when you release the key).	NA
When holding on a frequency	Switch to the GPS Navigation display.	Input the corresponding number in Direct Entry mode.		
Key Name (2nd operation) Action on:	 Menu	 ./ No (Decimal)	 0	 Yes (Enter)
Tap	Enter the Menu Mode.	NA	NA	If stopped on a frequency, store the current frequency.

FUNCTION + Tap	Enter the "Search for..." Menu.	NA	NA	NA
When holding on a frequency	Enter the Menu Mode.	Input the corresponding key in Direct Entry mode.		Accept entered value for Direct Entry mode.
Key Name (2nd operation) Action on:	 SQUELCH	 VOLUME	 SCAN/SEARCH	 HOLD/RESUME
Rotate	Adjust Squelch.	Adjust volume. Turn fully counterclockwise past click to turn off scanner.	NA	NA
Tap	Turn off Close Call mode.	Change backlight level.	Go to Scan mode	Hold on the most recent Close Call hit frequency. If you have not received a Close Call hit, NA.
Press & Hold	NA	NA	NA	NA
FUNCTION + Tap	Go to Fire Tone-Out Mode	Go to P25 status mode.	Go to the Quick Search prompt.	If on a Close Call hit, hold on the current frequency. Otherwise, NA.

Key Name (2nd operation) Action on:	 LOCKOUT	 SCROLL - FUNCTION
---	---	--

Rotate	NA	If stopped on a Close Call, resume Close Call.
Tap	If stopped on a frequency, temporarily lockout the frequency.	Activate the FUNCTION mode for the next keypress.
Function + Tap	Go to the lockout review mode.	NA
Double Tap	If stopped on a frequency, permanently lockout the frequency.	NA
Press & Hold	If stopped on a frequency, unlock all search frequencies.	"Latch" the FUNCTION mode. Scanner stays on the current system and all keypresses use the FUNCTION mode until you tap the control again.

This page applies to the following scanner(s): [BCD996XT Users Guide](#)

Band Scope mode

Band Scope mode is a special type of Search mode where the scanner displays the strength of any signal it finds.

- In a band scope search, the scanner starts at the lowest frequency in the range and moves up the search range.
- In *Max Hold* Search mode, the scanner displays the strongest signal that it found.
- If you manually set the mode to NFM or FM, the scanner will not reliably detect signals that are modulated in either FMB or WFM.

To turn on Band Scope mode:





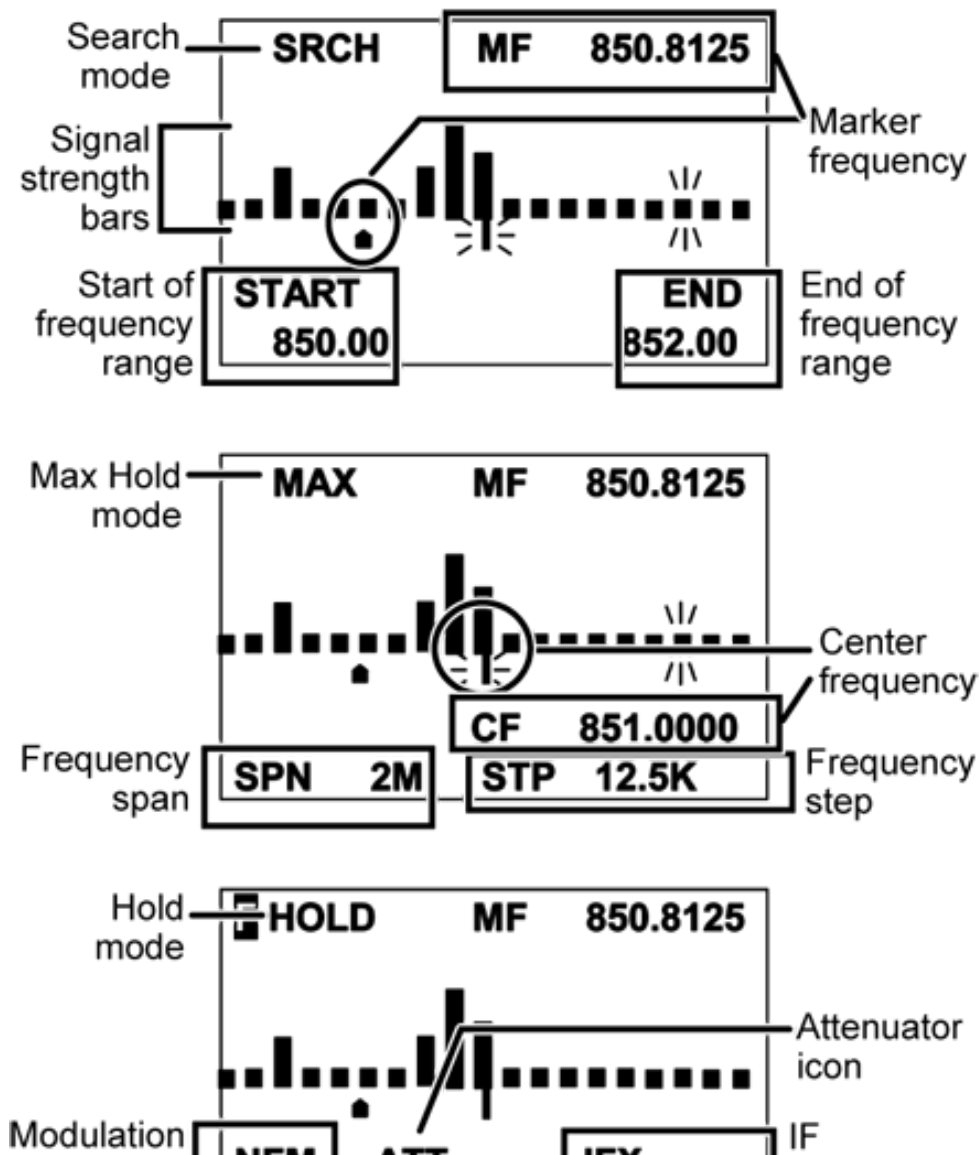

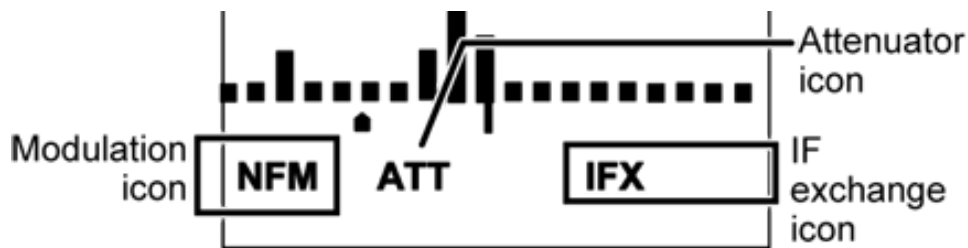





Band Scope mode is the default setting for Search Key 3. To turn on Band Scope mode, enter Hold or Search mode, then tap **FUNCTION + 3 (SR3)**. (To change the Search Key assignment, see [Search Keys#Programming Search Keys](#).)



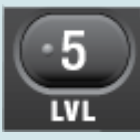





Reading the display in Band Scope mode







Key Operation in Band Scope Mode

Key Name (2nd operation)	 PRIORITY	 1 (Search 1)	 2 (Search 2)	 3 (Search 3)
Action On				
Tap	NA	NA		
FUNCTION + Tap	NA	Start the search range assigned to this Search Key.		
Key Name (2nd operation)	 Weather	 4 (IF exchange)	 5 (Level offset)	 6 (Display mode)
Action on:				
Tap	Toggle Weather Priority Mode	NA		
FUNCTION + Tap	Toggle Weather Priority Mode	Toggle the IF for that the current frequency.	NA	NA
Press & Hold	Go to Weather Scan mode.	NA	NA	NA
Key Name (2nd operation)	 GPS	 7 (Attenuation)	 8 (Reverse freq.)	 9 (Modulation)
Action on:				
Tap	Switch to the GPS Navigation display.	NA		
FUNCTION + Tap	Switch to the GPS Navigation display.	Toggle the attenuator state.	NA	Change the modulation.

FUNCTION + Press & hold	NA	Toggle the attenuator state for all signals.	NA	NA
Key Name (2nd operation) Action on:	 Menu	 ./ No (Decimal)	 0	 Yes (Enter)
Tap	Enter the Menu Mode.	Press to enter the Band Scope Setting mode and select a setting. The selected setting flashes. In Band Scope Setting mode, selects the next setting.	NA	Set the marker frequency as the center frequency. In Band Scope Setting mode, with CF selected edit the center frequency.
FUNCTION + Tap	Enter the Menu Mode.	NA	NA	NA
Key Name (2nd operation) Action on:	 SQUELCH	 VOLUME	 SCAN/SEARCH	 HOLD/RESUME
Rotate	Adjust Squelch.	Adjust volume. Turn fully counterclockwise past click to turn off scanner.	NA	NA
Tap	Change Close Call mode.	Change backlight level.	Resume scanning.	Hold on the current frequency. Press again to resume.
Press & Hold	Go to Close Call Only mode.	NA	NA	Hold on the current frequency. Press again to resume.

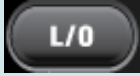
FUNCTION + Tap	Go to Tone-Out Mode.	Go to P25 fine-tune mode.	Switch between Max Hold Search mode and Search Mode.	Hold on the current frequency. Press again to resume.
--------------------------	----------------------	---------------------------	--	---

Key Name (2nd operation) Action on:	 LOCKOUT	 SCROLL - FUNCTION
Rotate	NA	Change the marker frequency one step frequency per click. In Band Scope Setting mode, change the selected parameter (except CF).
Function + Rotate	NA	Change the marker frequency one "bar" per click.
Tap	In Band Scope setting mode, return to the normal Band Scope mode.	Activate the FUNCTION mode for the next keypress.
Function + Tap	Restart the Band Scope.	NA

This page applies to the following scanner(s): [BCD996XT UsersGuide](#)

GPS Mode

To determine whether the information on this page applies to your scanner, see the tags at the bottom of the page.

You must have a [compatible GPS receiver](#) connected!

- [GPS Mode](#)
 - [See Also](#)
 - [Reading the display in GPS mode](#)
 - [GPS Data display](#)
 - [ETA / Clock / Elevation / Speed Display](#)
 - [Location Display](#)
 - [Location Alert display](#)
 - [Location review display](#)
 - [Keypad controls in GPS Review Location Mode](#)
 - [Keypad controls in GPS Mode](#)

See Also

GPS mode is only one small part of location-based scanning. For more information on using your scanner with a GPS receiver, see the following links:

[Location-based Scanning](#) contains

- an overview of why you might want to use a GPS receiver with your scanner
- an explanation of two different approaches to location-based scanning
- some information on finding antenna locations

[Programming locations](#) contains

- details on how to program locations for systems, sites, and channels
- details on how to program Points of Interest (*POI*), Dangerous Roads, and Dangerous Intersections (*Dangerous Xing*)
- information on reviewing and editing locations

[Connecting a GPS receiver](#) contains

- details on which GPS receivers are compatible
- instructions on connecting a GPS receiver
- troubleshooting tips if you can't the receiver working with the scanner





Reading the display in GPS mode

There are several displays available in GPS mode.

GPS Data display

<p>SW 01:23P</p> <p>39 mph 544 ft</p> <p>OFF</p> <hr/> <p>SCAN ↑</p>	<ul style="list-style-type: none"> • Direction of Travel • Current Time • Current Speed • Current Elevation • OFF indicates no POI is selected
---	---

ETA / Clock / Elevation / Speed Display

<p> SW 1h 10m</p> <p>15.03 mi</p> <p>HOME</p> <hr/> <p>SCAN ↑</p>	<p>These displays are available if you select a POI.</p> <ul style="list-style-type: none"> • Large arrow shows direction to the POI • Current Direction of Travel • Distance to the POI • Upper right corner depends on display mode: <ul style="list-style-type: none"> ○ ETA to POI ○ Current time ○ Current elevation ○ Current speed
<p> SW 13:23</p> <p>15.03 mi</p> <p>HOME</p> <hr/> <p>SCAN ↑</p>	
<p> SW 166 m</p> <p>24.19 km</p> <p>HOME</p> <hr/> <p>SCAN ↑</p>	
<p> SW 62 kph</p> <p>24.19 km</p> <p>HOME</p> <hr/> <p>SCAN ↑</p>	

Location Display

<p>N 32° 57' 33.60 W 97° 05' 34.18</p> <hr/> <p>HOME</p> <p>SCAN ↑</p>	<ul style="list-style-type: none"> • Latitude of current location • Longitude of current location • OFF if no POI selected, otherwise the name of the POI
---	--

Location Alert display

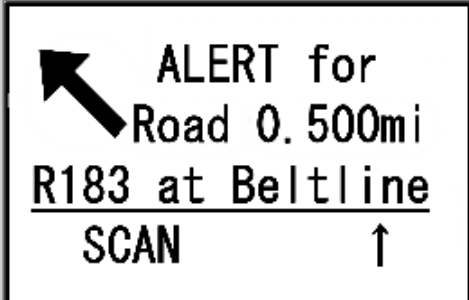



	<ul style="list-style-type: none"> • Location Alert Type • Distance to Alert location • Location Alert Name • Direction to Alert location • ALERT indicator also flashes when you approach a Dangerous Crossing or Dangerous Road
---	--





Location review display

<p>POI L/O GPS</p> <p>Review Location Hollywood</p> <p>RANGE: 0.10 MILE</p> <p>N 00° 00' 00.00 W 000° 00' 00.00</p>	<p>DXG L/O GPS</p> <p>Review Location Crossroad</p> <p>HEAD: ALL LS: 75M</p> <p>N 00° 00' 00.00 W 000° 00' 00.00</p>	<p>DRD L/O GPS</p> <p>Review Location Crossroad</p> <p>HEAD: NW LS: 75K</p> <p>N 00.000000 W 000.000000</p>
<p>These displays show the details of each location you've set. SCROLL to go to the next location.</p>		

Keypad controls in GPS Review Location Mode





Keys not listed have no function in this mode.





Key Name					
(2nd operation)	GPS	MENU	Yes (Enter)	LOCKOUT	
Action on:					
Tap	NA	Return to GPS Mode	Go to the menu mode.	Change the lockout status of the current location.	

Press & Hold	Overwrite the selected location with the current location.	NA	NA	Unlock all locations of the current type (POI, Dangerous Road, Dangous Crossing)	
FUNCTION + Press & Hold	NA	NA	NA	Display "Unlock All Locations?" If you press E/YES all locations of all types are unlocked.	
Key Name (2nd operation) Action on:	 SQUELCH	 VOLUME	 SCROLL - FUNCTION	 SCAN/SEARCH	 HOLD/RESUME
Rotate	Adjust Squelch.	Adjust volume. Turn fully counterclockwise past click to turn off scanner.	Select a location.	NA	NA
Tap	NA	Change backlight level.	Activate the FUNCTION mode for the next keypress.	Go to Scan Mode	Go to Scan Hold mode.
Press & Hold	NA	NA	"Latch" the FUNCTION mode. Scanner stays on the current system and all keypresses use the FUNCTION mode until you tap the control again.	NA	NA

Keypad controls in GPS Mode

Keys not listed have no function in this mode.

Key Name (2nd operation) Action on:	 GPS	 MENU	 Yes (Enter)	 LOCKOUT	 6 / DISPLAY
Tap	NA	Go to the Menu mode.	Go to the review location mode.	Temporarily lockout the current location alert if it one is active.	NA
Double Tap	NA	NA	NA	Permanently lockout the current location alert if it one is active.	NA
Press & Hold	Store the current location.	NA	NA	NA	NA

Function + Tap	NA	Go to the menu mode to edit the current location.	NA	Temporary lockout the current location alert if one is active.	Switch between GPS display modes.
Key Name (2nd operation) Action on:	 SQUELCH	 VOLUME	 SCROLL - FUNCTION	 SCAN/SEARCH	 HOLD/RESUME
Rotate	Adjust Squelch.	Adjust volume. Turn fully counterclockwise past click to turn off scanner.	Select a POI.	NA	NA
Tap	NA	Change backlight level.	Activate the FUNCTION mode for the next keypress.	Return to previous operation.	Hold on the current channel.
Press & Hold	NA	NA	"Latch" the FUNCTION mode. Scanner stays on the current system and all keypresses use the FUNCTION mode until you tap the control again.	NA	Hold on the current system. If already holding on a system, resume normal scanning when in scan mode.
Function + Rotate	NA	NA	Quickly skip to the location starting with the next alphabetic character.	Return to previous operation.	NA

This page applies to the following scanner(s): [BCD996XT Users Guide](#)

BCD396XT Specs

To determine whether the information on this page applies to your scanner, see the tags at the bottom of the page.

- Certified in accordance with FCC Rules and Regulations Part 15 Subpart C as of date of manufacture. (See [FCC Information](#) for more details.)
- FCC ID: AMWUB359
- [General](#)
- [Frequency Range](#)
- [Special Functions](#)
 - [Band Scope Function](#)
 - [Two-Tone-Sequential](#)
 - [WX Alert](#)
- [Supported trunking systems](#)
- [Dynamic memory allocation capacity](#)
- [Heterodyne System](#)
- [CTCSS and DCS Tones](#)

General

Attenuation	20dB nominal
Audio Output Power	310mW nominal into 24 speaker
	20mW nominal into 32 stereo headphone
Scan Rate	100 channels per second max (Conventional mode)
Search Rate	300 steps per second max (5kHz steps only)
External Jacks	Antenna Jack: SMA Type
	Phone Jack: 3.5mm (1/8 in.) Stereo Type

	DC Power Jack: EIAJ TYPE-(Center Positive)
	GPS/Remote Interface Jack: 4pin Mini Type
Internal Speaker	24 , 0.8 W Max.(1.26 in.)
Power Requirements	3 x AA Size Rechargeable Ni-MH Batteries (2300mAh)
	3 x AA size Alkaline Batteries
	AC Adapter (6V DC 800mA Regulated) (AD-1001)
Operating Temperature	Nominal: -20°C to +60° -4°F to +140°F
	Close Call: -10°C to +60°C +14°F to +140°F
Size	2.40 in.(W) x 1.22 in.(D) x 5.35 in.(H) (Without Antenna)
Weight	0.37 lbs (Without Battery and Antenna)
Remote Functions	Direct PC control
	Database management
	Wired cloning
Display	64 x 128 Full Dot Matrix LCD with multi-color back light

Sensitivity (nominal) 12dB SINAD		
0.4•V	25—27.995 MHz	AM
0.3•V	28—53.98 MHz	NFM

0.5•V	54—71.95 MHz	WFM
0.2•V	72—75.995 MHz	FM
0.4•V	76—107.9 MHz	FMB
0.3•V	108—136.9916 MHz	AM
0.3•V	137—173.9875 MHz	NFM
0.5•V	174—215.95 MHz	WFM
0.3•V	216—224.98 MHz	NFM
0.3•V	225—379.975 MHz	AM
0.3•V	380—512 MHz	NFM
0.3•V	763—960 MHz	NFM
0.5•V	1240—1300 MHz	NFM

Signal Noise Ratio (nominal)		
50dB	25—27.995 MHz	AM
41dB	28—53.98 MHz	NFM
55dB	54—71.95 MHz	WFM
47dB	72—75.995 MHz	FM
60dB	76—107.9 MHz	FMB

50dB	108—136.9916 MHz	AM
41dB	137—173.9875 MHz	NFM
55dB	174—215.95 MHz	WFM
40dB	216—224.98 MHz	NFM
51dB	225—379.975 MHz	AM
40dB	380—512 MHz	NFM
41dB	763—960 MHz	NFM
37dB	1240—1300 MHz	NFM

Close Call Sensitivity (nominal)	
350•V	VHF Low1 Band
160•V	VHF Low2 Band
70•V	Air Band
60•V	VHF High1 Band
56•V	VHF High2 Band
100•V	UHF Band
200•V	800MHz+ Band

Frequency Range

Frequency Range (MHz)	Modulation	Step (kHz)	Name
25.0000—26.9600	AM	5	Petroleum Products & Broadcast Pickup
26.9650—27.4050	AM	5	CB Class D Channel
27.4100—27.9950	AM	5	Business & Forest Products
28.0000—29.6800	NFM	20	10 Meter Amateur Band
29.7000—49.9900	NFM	10	VHF Low Band
50.0000—53.9800	NFM	20	6 Meter Amateur Band
54.0000—71.9500	WFM	50	VHF TV
72.0000—75.9950	FM	5	Intersystem & Astronomy
76.0000—87.9500	WFM	50	VHF TV
88.0000—107.9000	FMB	100	FM Broadcast
108.0000—136.9916	AM	8.33	Aircraft Band
137.0000—143.9875	NFM	12.5	Military Land Mobile
144.0000—147.9950	NFM	5	2 Meter Amateur Band
148.0000—150.7875	NFM	12.5	Military Land Mobile
150.8000—161.9950	NFM	5	VHF High Band
162.0000—173.9875	NFM	12.5	Federal Government
174.0000—215.9500	WFM	50	VHF TV

216.0000—224.9800	NFM	20	1.25 Meter Amateur Band
225.0000—379.9750	AM	25	Military Aircraft Band
380.0000—399.9875	NFM	12.5	Military Land Mobile
400.0000—405.9875	NFM	12.5	Miscellaneous
406.0000—419.9875	NFM	12.5	Federal Government Land Mobile
420.0000—449.9875	NFM	12.5	70 cm Amateur Band
450.0000—469.9875	NFM	12.5	UHF Standard Band
470.0000—512.0000	NFM	12.5	UHF TV
763.0000—775.99375	NFM	6.25	Public Service Band
793.0000—805.99375	NFM	6.25	Public Service Band
806.0000—823.9875	NFM	12.5	Public Service Band
849.0125—868.9875	NFM	12.5	Public Service Band
894.0125—960.0000	NFM	12.5	Public Service Band
1240.0000—1300.0000	NFM	25	25 cm Amateur Band

Special Functions

Band Scope Function

- Frequency Span 0.2 Mhz To 500 Mhz
- Frequency Step 5 Khz To 100 Khz

Two-Tone-Sequential

- 250.0-3500.0Hz , 0.1Hz Step Programmable

WX Alert

- 1050 Hz Tone System
- NWR-SAME System (Warning / Watch / Statement)

Supported trunking systems

- Motorola Systems: Type I, II, II/I (hybrid)
- EDACS Systems: FM, NFM, and SCAT
- LTR Systems
- APCO Systems: Astro Imbe, Astro 25

Dynamic memory allocation capacity

- Systems: 500 max
- Groups: 20 per system
- Site: 1000 max (All) 256 per system
- Channels: 25000 max (40128 memory blocks)
- Channels per Trunked System: 500 max

Heterodyne System

- 1st IF: 380.7 to 380.8 MHz / 265.5 to 265.6 MHz
- 2nd IF: 10.8 MHz
- 3rd IF: 450 kHz

CTCSS and DCS Tones

CTCSS Tone Frequencies (50 frequencies total)									
67.0	69.3	71.9	74.4	77.0	79.7	82.5	85.4	88.5	91.5
94.8	97.4	100.0	103.5	107.2	110.9	114.8	118.8	123.0	127.3
131.8	136.5	141.3	146.2	151.4	156.7	159.8	162.2	165.5	167.9
171.3	173.8	177.3	179.9	183.5	186.2	189.9	192.8	196.6	199.5

203.5	206.5	210.7	218.1	225.7	229.1	233.6	241.8	250.3	254.1
-------	-------	-------	-------	-------	-------	-------	-------	-------	-------

DCS Tone Codes (104 codes total)							
023	025	026	031	032	036	043	047
051	053	054	065	071	072	073	074
114	115	116	122	125	131	132	134
143	145	152	155	156	162	165	172
174	205	212	223	225	226	243	244
245	246	251	252	255	261	263	265
266	271	274	306	311	315	325	331
332	343	346	351	356	364	365	371
411	412	413	423	431	432	445	446
452	454	455	462	464	465	466	503
506	516	523	526	532	546	565	606
612	624	627	631	632	654	662	664
703	712	723	731	732	734	743	754

This page applies to the following scanners: [BCD396XT Users Guide](#)

BCD396XT

The Complete Reference

This document provides a complete reference to all menus, functions, and features of the BCD396XT Digital Trunk Tracker Scanner from Uniden. It is based on the Operation Specification that is used both as a guide to the software engineers for creating the scanner's user interface and as a repository for the "final say" on how every feature and function is implemented.

Some proprietary information has been removed, formatting has been modified, and extensive editing has been performed to make the text more readable. However, you will almost certainly find a handful of odd turns of phrases.

Mostly, though, we hope that this reference work can help you better understand and use your BCD396XT. This document isn't intended to be a guide for how to use your scanner...you'll find that information in the Owner's Manual...but rather a reference for all the things that the scanner does. Combined with the Owner's Manual and the great resources available to scanner users online, you now have more information than ever on every facet of your scanner.

© 2009 Uniden Corporation
Fort Worth, TX
All Rights Reserved.

Contents

Feature Summary	8
Band Coverage	8
Channels	9
Memory Architecture	9
Channel Memory Scan	9
Priority Scan	9
Priority Plus Scan	9
Search with Scan	9
Scan Speed	9
Scanning Lockout	10
Temporary Lockout	10
Quick Keys	10
Startup Configuration	10
Channel Alert	10
Alpha Tagging	10
Duplicate Input Alert	10
Number Tag	10
Trunk Tracking	10
Multi-Site System	11
Control Channel Only	11
P25 One-Frequency Trunking	11
Priority ID Scanning	11
Preemptive Priority ID Scanning	11
Trunking Activity Indicators	11
Custom Search	11
Quick Search	11
Frequency Autostore	11
Search Speed / Turbo Search	11
Search Lockout	12
Search Key	12
Service Search	12
Broadcast Screen	12
Attenuator	12
Code Search	12
P25 NAC	12
Volume Offset	12

IF Exchange	12
Dropout Delay	13
Weather and SAME Alert.....	13
Close Call [®] Frequency Capture	13
Close Call Temporary Store	13
Tone-Out Sequential Decode	13
Location-Based Scanning*	13
Location Alert System*.....	13
Navigation Modes*	13
GPS Compatibility*	13
Wired Cloning.....	13
Band Scope.....	13
PC Control.....	14
LCD and Keypad Backlight.....	14
Alert Tone Level	14
Battery Low Alert.....	14
Battery Save.....	14
Key Lock	14
Key Safe Mode.....	14
Audio AGC	14
Repeater Reverse.....	14
Memory Backup	14
Design	15
Controls and Keys.....	16
Displays.....	21
LCD Design.....	21
Icons.....	21
Dot Matrix.....	22
LCD Flashing Time	22
Tones	23
General Tones	23
Weather Alert Sirens.....	23
Tones in Menu Mode	24
Selecting a menu item	24
Editing a name or a frequency etc.....	24
Alert in Scanner Mode	24
Alert in GPS Mode	24

Alert for Point Of Interest	24
Alert for Dangerous Xing.....	24
Alert for Dangerous Road	24
Battery Low Tone.....	24
Operation	25
Power On	25
Volume and Squelch Control	26
Volume Adjust Mode.....	26
Squelch Adjust Mode	26
P25 Condition Mode	27
State Transition Diagram	27
Menu Mode	28
General Operations.....	28
Error Messages.....	31
Top Menu	32
Program System	32
Program Site	45
Program Group	55
Program Channel.....	59
Program Location.....	67
Srch/CloCall Opt	72
Search for.....	78
Close Call.....	89
Priority Scan.....	94
WX Operation.....	95
Tone-Out for	98
Wired Clone	102
Settings	103
SCAN MODE	111
Display during Scan Mode.....	111
Startup Key Operation	111
Start Scanning.....	111
Scanning Order	113
Scanning Operation	114
Temporary System Hold	126
System Hold.....	127
Quick System Select.....	127

Quick Save for CTCSS/DCS/P25 NAC Data.....	128
Key Operation During Scan	129
SCAN HOLD MODE	131
Display while in Scan Hold Mode	131
General Operation.....	131
Hold on Conventional System	135
Hold on Trunked System	135
Hold on TalkGroup ID from ID Search / ID Scan.....	136
Direct Entry	136
Key Operation During Scan Hold Mode	139
PRIORITY SCAN.....	142
Priority Scan.....	142
Priority Plus Scan.....	143
Key Operation During Priority Scan.....	143
PRIORITY ID SCAN	144
Priority ID Scan	144
Key Operation During Priority ID Scan	144
SEARCH MODE	145
Display during Search Mode.....	145
General Operation.....	145
Service Search.....	146
Custom Search	147
Custom Search in Control Channel Only Mode.....	148
Search and Store	149
Quick Search.....	149
Key Operation During Search Mode.....	151
SEARCH HOLD MODE	153
General Operation.....	153
Go to Quick Search Hold Directly	153
Direct Entry	153
Quick Save	154
Key Operation During Search Hold Mode	155
CLOSE CALL MODE	157
Display during Close Call Mode.....	157
Close Call Search	157
Close Call Only	160
Close Call Hold	161

Close Call Auto Store.....	161
CC Hit with Scan.....	162
Direct Entry / Quick Save / Go to Quick Search Hold Mode	162
Key Operation During Close Call Only Mode	163
Key Operation During Close Call Hold Mode	164
WEATHER SCAN MODE	167
Normal Weather Scan.....	167
Weather Alert Scan.....	167
Weather (Alert) Scan Hold	168
Weather Alert Priority (WX Alt Priority)	169
Direct Entry / Quick Save.....	169
Key Operation During Weather (Alert) Scan Mode	169
Key Operation During Weather (Alert) Scan Hold Mode.....	170
TONE-OUT MODE	172
Display during Tone-Out Mode.....	172
Tone-Out Standby Mode.....	173
Tone-Out Search Mode	175
Tone-Out Hold Mode	176
Key Operation During Tone-Out Mode	177
GPS MODE.....	179
Display Mode in GPS Mode.....	179
Location Alert Operation	181
Registration of Location Information	184
Review Location Mode.....	185
Key Operation During GPS Mode.....	187
BAND SCOPE MODE.....	189
Scope Mode	189
Search Mode.....	190
Max Hold Search Mode	190
Hold Mode.....	191
General Operation.....	191
Search Setting Parameters.....	193
Key Operation during Band Scope Mode	194
WIRED CLONE MODE	196
Confirm State	196
Transferring State	196
Complete State	196

Error State	197
Key Operation During Clone Mode	197
KEYLOCK	198
KEY SAFE MODE	199
Changed Key Operation in Key Safe Mode	199
Key Safe Operation	200
Key Safe Message	200
MEMORY INITIALIZATION	201
BATTERY CHARGE	202
Battery Type Select	202
Charging the Battery	202
OTHERS	205
AVAILABLE SYSTEM SETTINGS	205
System Settings	205
System Option Settings	205
Site Settings	206
Site Frequency Settings	206
Channel Settings	207
TGID FORMAT FOR TRUNKED SYSTEM	208
FLEET MAP	215
PRESET FLEET MAPS	216
WEATHER CHANNELS	217
CTCSS FREQUENCY	217
DCS CODE	217
CEA2009-SAME EVENT CODE(ANSI/CEA-2009-A October 2005)	218
REMOTE COMMAND	220
CTCSS/DCS CODE LIST	264

Feature Summary

Band Coverage

Frequency (MHz)		Modulation	Step (kHz)	Remark
Lower Edge	Upper Edge			
25.0000	26.9600	AM	5.0	Petroleum Products & Broadcast Pickup
26.9650	27.4050	AM	5.0	CB Class D Channel
27.4100	27.9950	AM	5.0	Business & Forest Products
28.0000	29.6800	NFM	20.0	10 Meter Amateur Band
29.7000	49.9900	NFM	10.0	VHF Low Band
50.0000	53.9800	NFM	20.0	6 Meter Amateur Band
54.0000	71.9500	WFM	50.0	VHF TV Broadcast 2 – 4
72.0000	75.9950	FM	5.0	Intersystem & Astronomy
76.0000	87.9500	WFM	50.0	VHF TV Broadcast 5 – 6
88.0000	107.9000	FMB	100.0	FM Broadcast
108.0000	136.9916	AM	8.33	Aircraft Band
137.0000	143.9875	NFM	12.5	Military Land Mobile
144.0000	147.9950	NFM	5.0	2 Meter Amateur Band
148.0000	150.7875	NFM	12.5	Military Land Mobile
150.8000	161.9950	NFM	5.0	VHF High Band
162.0000	173.9875	NFM	12.5	Federal Government
174.0000	215.9500	WFM	50.0	TV Broadcast 7 – 13
216.0000	224.9800	NFM	20.0	1.25 Meter Amateur Band
225.0000	379.9750	AM	25.0	UHF Aircraft Band
380.0000	399.9875	NFM	12.5	Military Band
400.0000	405.9875	NFM	12.5	Miscellaneous
406.0000	419.9875	NFM	12.5	Federal Government Land Mobile
420.0000	449.9875	NFM	12.5	70 cm Amateur Band
450.0000	469.9875	NFM	12.5	UHF Standard Band
470.0000	512.0000	NFM	12.5	UHF TV
763.0000	775.9937	NFM	6.25	Public Service Band
793.0000	805.9937	NFM	6.25	Public Service Band
806.0000	823.9875	NFM	12.5	Public Service Band
849.0125	868.9875	NFM	12.5	Public Service Band
894.0125	960.0000	NFM	12.5	Public Service Band
1240.0000	1300.0000	NFM	25.0	25 cm Amateur Band

Notes on Band Coverage:

- You can edit the Modulation and Step for each band. The above table shows the factory default values.
- Although TV bands are listed, the BCD396XT cannot decode Digital TV audio.
- When you select “AUTO” for a channel or mode’s Modulation or Step, the above value is used (unless you’ve edited the Band Defaults).

Channels

Dynamic – You can create up to 25,000 total conventional channels, trunked channels, and trunked system frequencies.

- Channels in a conventional system contain a frequency.
- Channels in a trunked system contain a talk group ID (TGID).

Memory Architecture

Absolute Limits:

Systems	500
Sites Total	1,000
Sites/System	256
Channel Groups per System	20
Channels+System Frequencies	25,000
Channels per conventional system	1000
Channels per trunked system	500
Trunk Frequencies per Site	500-1000 (depending on total TGIDs stored in the system)

Notes about limits:

- The actual results will be limited by the first absolute limit you hit. For example, if you have created 1000 sites, you will not be able to create a new system even though you have created fewer than 500 systems.
- You can check the % of memory used by using the menu.

Channel Memory Scan

The scanner can scan any combination of trunked and conventional systems simultaneously.

Priority Scan

The scanner checks conventional priority channels every 1-10 seconds (2 seconds default) when scanning a conventional system.

Priority Plus Scan

The scanner scans only the conventional priority channels.

Search with Scan

The scanner can do Service and Custom Searches along with system scanning.

Scan Speed

100 Channels/Second (max) for conventional systems.

Scanning Lockout

You can lock out any System, Site, Channel Group, Channel, or search frequency.

Locked out channels are skipped (or ignored) during scanning.

If a system, site, or channel group is locked, all channels belonging to it will be skipped during scanning.

Temporary Lockout

Sites, Systems, Channels, or Frequencies temporarily locked out are automatically unlocked when power is cycled.

Quick Keys

You can assign an SQK (System/Site/Search Quick Key) from 0-99.

You can assign a GQK (channel Group Quick Key) from 0-9.

Quick keys can be rapidly enabled/disabled from the keypad during scanning.

Startup Configuration

You can assign a startup configuration key to a system or search range so that it can be automatically locked out or unlocked during power up.

Channel Alert

You can set a separate audible/visual alert for each channel.

Alpha Tagging

You can assign an alphanumeric name to each System, Site, Channel Group, Channel, Location, Custom search range, SAME group, and Tone-Out. You can use 16 characters per tag.

Duplicate Input Alert

The scanner will alert you if an entered alpha tag, frequency, etc has already been used in the same system.

Number Tag

You can assign a unique number tag from 0-999 to each system and to each channel within a system. This tag allows you to rapidly tune to a specific channel.

Trunk Tracking

The scanner can track the following types of trunked systems:

- Motorola Type I 800
- Motorola Type II 800, 900, UHF, VHF
- Motorola Rebanded
- EDACS Wide, Narrow, SCAT
- EDACS ESK (No ProVoice Decoding)
- LTR
- APCO P25 Standard, P25 One-Frequency

Multi-Site System

All trunked systems can have more than one site. All sites in the system share the same Channel Groups and Channels.

Control Channel Only

Trunk Tracking can be achieved by entering only the control channels for Motorola and P25 systems.

P25 One-Frequency Trunking

The scanner can follow individual talk groups on P25 single-frequency systems that use both NAC and TGID's for squelch control and user identification. ID Search and ID Store are available, just like on trunked systems.

Priority ID Scanning

Trunked channels can be assigned priority. When the scanner is monitoring the control channel, channels you tag as priority are given a higher priority over non-priority channels when they become active.

Preemptive Priority ID Scanning

For Motorola systems that have channel priority active on the system, if you flag a channel as priority and the system also has that TGID identified as a priority channel, the scanner will preempt any current transmission if the TGID becomes active.

Trunking Activity Indicators

The scanner shows all trunked activity when you hold on the control channel.

Custom Search

You can program up to 10 custom search ranges and either search them exclusively or include these searches when scanning.

Quick Search

If you hold on a conventional channel, you can start searching from the current frequency. If you hold on a trunked channel, you can quickly switch to ID Search mode.

Frequency Autostore

The scanner can automatically store frequencies found during a search.

Search Speed / Turbo Search

- 100 Steps/Second in search mode (max, except for 5 kHz steps)
- 300 Steps/Second in search mode (max, 5 kHz steps)
- Turbo mode automatically applies to 5 kHz step searches.

Search Lockout

You can lock out up to 500 frequencies.

- The limit of temporary L/O frequencies: 250
- The limit of permanent L/O frequencies: 250
- Locked out frequencies will be skipped in Search Mode or Close Call Mode.
- You can review all locked out frequencies in Menu Mode.

Search Key

Search keys are short cuts to start searching for a single search range.

There are 3 search keys (sr1 to sr3).

Service Search

You can search preset frequencies typically used by specific agencies or groups.

The kind of Service Search is as follows: Public Safety, News, HAM Radio, Marine, Railroad, Air, CB Radio, FRS/GMRS/MURS, Racing, FM Broadcast, Military Air, Special

Broadcast Screen

Allows the scanner to ignore hits on Pager, FM, UHF TV, VHF TV, NOAA WX and custom band frequencies.

Attenuator

You can attenuate the incoming signal for channels that get interference from strong signal sources.

You can set a global attenuator to apply attenuation to all reception.

Code Search

Rapid search for the CTCSS/DCS used during a transmission.

The scanner does not detect or decode P25 signals if you are operating CTCSS/DCS Search.

P25 NAC

P25 Network Access Code (NAC) is used to provide selective squelch operation on channels. The scanner can also search for the NAC code that is being used on a P25 digital channel.

Volume Offset

Adjust the volume level for any channel from -3 to +3 steps to balance audio level.

IF Exchange

Switches the current frequency to use a different IF (intermediate frequency) for receiving radio signals to avoid interference.

Dropout Delay

Controls whether the scanner pauses at the end of a transmission to wait for a reply.

You can set the Delay time for each System. All Channels in the System share the same delay setting. You can also set the Delay time for Search, Close Call and Tone-Out.

You can set the minus delay time. In that case, the scanner only stops on transmissions for the set duration, then automatically resumes.

Weather and SAME Alert

The scanner can alert to Weather Alert Tone, all FIPS or selected FIPS.

Close Call® Frequency Capture

The scanner can immediately detect and lock onto a transmission above threshold signal strength.

Close Call Temporary Store

The scanner scans the last 10 frequencies captured by Close Call so that you can continue to receive the signal even after the signal is not strong enough to trigger a Close Call hit..

Tone-Out Sequential Decode

Lets you set the scanner to act as a two-tone pager for fire tone-out standby. If you do not know the tones being used, the scanner can detect the tones when it receives a page.

Location-Based Scanning*

The scanner can automatically lock and unlock systems, sites and channel groups based on your current location as provided by an external GPS unit (not included).

Location Alert System*

The scanner alerts you when you approached a stored location.

Navigation Modes*

Indicate the Direction / Distance / Time to Goal for locations you set.

GPS Compatibility*

Compatible GPS units output location data that conforms to NMEA-0183 v3.01. The scanner uses the GGA and RMC sentences as defined by that specification. Note that this standard specifies an RS232 serial connection. GPS units that have USB connectivity are not compatible with this scanner.

Wired Cloning

You can clone all programmed data, including Memory Architecture, Menu settings and other parameters from one BCD396XT to another BCD396XT connected with RS232C cable.

Band Scope

Band Scope Mode searches a frequency range and displays a graphic of the signal level in real time.

In Band Scope Hold Mode, the user can monitor the frequency displayed.

PC Control

You can download information into the scanner and control the scanner via your personal computer.

LCD and Keypad Backlight

You can select your desired LCD backlight color from White, Red, Magenta, Blue, Green, Cyan, or Yellow.

The Keypad backlight is single white.

The backlight can be adjusted to 3 different brightness levels

Alert Tone Level

This feature lets you adjust the volume level of the following tones: Key Beep, Emergency Alert, Channel Alert, Close Call Alert, Tone-Out detection Alert, Battery Low Alert and Location Alert.

Battery Low Alert

When the battery voltage becomes low, the  icon will blink and a Battery Low Tone will be generated every 15 seconds. This alert level is set at the same level as the key beep volume level.

Battery Save

You can turn on/off this function by Menu Operation.

This works when there is no transmission over 1 minute in the following modes. This feature turns off RF power for 1 second and turns on it 300 ms to extend the battery life.

- Scan Hold Mode at a Channel of conventional System (without Priority Scan)
- Any Search Hold Mode

Key Lock

This feature disables the keypad and scroll to prevent any accidental input.

Key Safe Mode

This mode helps keep novice users from accidentally changing parameters or modes.

Some keys don't work in this mode.

Audio AGC

The scanner judges strength of the signal and changes the volume automatically.

Repeater Reverse

One-touch key lets you switch to hearing the input frequency on a conventional repeater system or trunked system.

Memory Backup

Scanner memory is backed up semi permanently.

Design

The below is a design reference. There might be some differences between this image and the actual final design.



Controls and Keys

“Long press” means pressing a key more than 2 second.

Each key has a “normal” mode and a “Function” mode.

Normal Mode:

Normal Mode means that the scanner is not in Function Mode. In this mode, the **F** icon is not displayed.

Function Mode:

- Pressing [FUNC] puts the scanner into Function Mode for 3 seconds. While it is in Function Mode, the scanner displays the **F** icon. If you press a button, the Function Mode time is continued for another 3 seconds.
- Long pressing [FUNC] puts the scanner into Function Mode without a timeout. The scanner displays “Function Key” and “Holding”, and the **F** icon blinks.

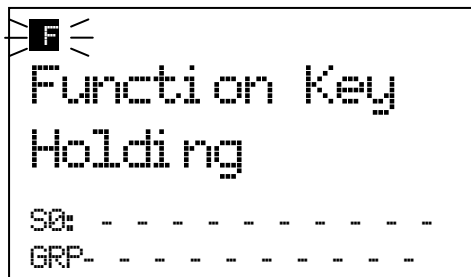

- Pressing [FUNC] again in each Function Mode returns to Normal Mode and the **F** icon disappears.

Scroll Control

- Selects a channel or frequency in Hold Mode.
- Selects Menu items in Menu Mode.
- Selects a character while editing the Name.
- Sets the level in Volume / Squelch Level Control mode.

Scroll Control Push

- Pressing this works the same operation as pressing [E / yes / gps] in Menu Mode.
- Press this to set the volume level in the mode that is not Menu Mode.

Function + Scroll Control

- Use to select a System in Scan or Scan Hold Mode.

Function + Scroll Control Push

- Press this to set the squelch level in any mode other than Menu Mode.

Scan / srch (Search) Key

- Press to resume scanning. (Scan Hold Mode and while monitoring a channel in Scan Mode)
- Press to go to Scan Mode. (Except Scan Mode, Scan Hold Mode and GPS Mode)
- Press to return to the scanner screen. (GPS Mode)

Function + Scan / srch Key

- Press to resume searching. (Search Hold Mode and while monitoring in Search Mode)
- Press to toggle between ID SCAN and ID SEARCH while scanning a trunked system.
- Press to display the Quick Search Prompt. (Except in Search Mode, Search Hold Mode, GPS Mode and Band Scope Mode)
- Press to return to the scanner screen. (GPS Mode)
- Press to change the band scope search type. (Band Scope Mode)

Hold / (Close Call) Key

- Press to go to each Hold Mode. (Scan Mode, Search Mode, Close Call Only Mode, WX Scan Mode and Band Scope Mode)
- In Close Call Only Mode, the scanner sounds an Error Tone if it has not yet gotten a hit.
- Press to resume scanning or searching. (Hold Mode)

Function + Hold / Key

- Toggles the setting of Close Call.
- Long press to start Close Call Only Mode.

L/O (Lockout) Key

- Press once to temporarily lock out a system channel, a search frequency or a location data. This lock out is canceled when the power is turned off then back on.
- Press twice within one second to permanently lock out a system channel, a search frequency or a location data. This lockout remains even if the power is turned off.
- Long press to unlock all settings of the current system. (Scan Mode and Scan Hold Mode)
- All Locations of the current Type are unlocked by long-pressing this key. (Review Location Mode)
- The scanner unlocks all frequencies of Global Lockout List*. (Search Mode, Search Hold Mode, Close Call Only Mode and Close Call Hold Mode)
- Press to cancel a prompt without changing settings in Menu Mode.

*Global Lockout List means collecting the locked out frequencies at Search Mode, Search Hold Mode, Close Call Only Mode and Close Call Hold Mode.

Function + L/O Key

- Press once to temporarily lock out the current system, current site or current search range in Scan Mode and Scan Hold Mode. This lock out is cleared when power is turned off then back on.
- Press twice in a second to permanently lock out the current system or current search range in Scan Mode and Scan Hold Mode. This locked out is kept even if the power is turned off.
- Press to go to Rvw Search L/O. (Search Mode, Search Hold Mode, Close Call Only Mode and Close Call Hold Mode)
- Long press to display the prompt to unlock all systems, sites, search ranges and Close Call Hits system and enable all Quick Keys for systems/sites/search ranges. (Scan Mode and Scan Hold Mode) If you press [E / yes / gps], the scanner unlocks all data. If you press [. / no / pri], the scanner returns to the previous mode without unlocking.
- Long press to display the prompt for unlocking all Locations of all types. (Review Location Mode of GPS Mode) If you press [E / yes / gps], the scanner unlocks all data. If you press [. / no / pri], the scanner returns to the previous mode without unlocking.

(Light) / (Power) / (Key Lock)

- Press to illuminate the LCD back light according to Menu setting.
- Press and hold to turn the scanner on or off.

Function + / / Key

- Press to lock or unlock the keypad.

1 - 9, 0 Key

- Press to enable or disable the System/Site/Search Quick Key for system or search range. (Scan Mode)
- Press to turn on or off each custom search range number. These keys operate only in Custom Search and not in other searches. (Search Mode)
- Press to go to Direct Entry Mode or to enter a Number Tag. (All Hold Mode, Close Call Mode and Tone-Out Mode)
- While editing a name, press [4 / LEFT] or [6 / RIGHT] to move the cursor to the left or right.

Function + 1 - 9, 0 Key

- Press to enable or disable Groups Quick Key in Scan Mode.

Function + 1 - 3 / sr1 - 3 (Search) Key

- Press [1 - 3 / sr1 - 3] to start Service Search, Custom Search, Tone-Out Mode or Band Scope Mode in Set Search Key. (except Scan Mode and GPS Mode)

Function + 4 / LEFT / ifx (IF Exchange) Key

- Press to exchange the IF (intermediate frequency) for receiving radio signals to avoid interference. (except Scan Mode and GPS Mode)

Function + 5 / lvl (Volume Offset) Key

- Press to change the volume offset level. (Scan Hold Mode)

Function + 6 / RIGHT / disp Key

- Press to change the Display Mode. (Scan Hold Mode and Custom Search Mode)
(Display mode 1 -> Display mode 2 -> Display mode 3 -> Display mode 1 ->....)
- Press to change the GPS Display. (GPS Mode)

Function + 7 / att (Attenuator) Key

- Press to toggle the attenuation state. (except GPS Mode)
- Long press to toggle global attenuator. (except GPS Mode)

Function + 8 / rev (Reverse) Key

- Press to monitor the current frequency's reverse frequency. It returns to current frequency when the key is released. (Scan Hold Mode, Search Mode, Search Hold Mode, Close Call Only Mode and Close Call Hold Mode)

Function + 9 / mod (Modulation) Key

- Press to change the modulation state. (except GPS Mode and WX Scan Mode)

Function + 0 / wx (Weather) Key

- Press to toggle WX Scan Mode and WX Alert Scan Mode while WX Scan or WX Alert Scan.
- Press to toggle WX Alert Priority. (except WX Scan Mode)
- Long press to start WX Scan. (except WX Scan Mode)

. (Decimal) / no / pri (Priority) Key

- Press to cancel these displays while displaying Error or Warning message.
- Press to input "."(decimal) for frequency.
- Press to input "-" or "i" for TGID.
- Press to input a space in editing a data name.
- Press twice to clear the data in editing data name.
- Press to input "-" or "i" for Direct Enter in Hold Mode, Close Call Only Mode, Tone-Out Mode.
- Press in Scan Mode to start the selection for the ten's place of a System/Site/Search Quick Key. Then, press number key to jump to each number's place of a Quick Key.

Function + . / no / pri Key

- Press to toggle Priority Mode in Scan Mode. (On / Plus On / Off)

E (Enter) / yes / gps Key

- Press to accept the input data or a Menu Item.
- Press to edit the channel data. (Scan Mode and Scan Hold Mode)
- Press to quickly save the frequency in Search Mode, Search Hold Mode, Close Call Mode, Close Call Hold Mode, WX Scan Mode and WX Scan Hold Mode.
- Press to go to the editing menu for current Tone-Out.
- Press to go to Review Location Mode. (GPS Mode)

Function + E / yes / gps Key

- Press to change GPS Mode.
- Long press to store a current location data.

Menu Key

- Press to enter the Menu Mode.
- Press to go back up one menu level when in the Menu Mode.
- Press after entering the value to indicate going to a number tagged system or channel.

Function + Menu Key

- Press to go to the editing menu for the current system, search range or location data.

Displays

LCD Design

The reference design shown below is for illustration purposes only and is not intended to be a photorealistic representation of the display.



Icons

- Sx: : This icon appears with icons of System and Site Quick Key numbers (from "0" to "99"). "x" shows the current ten's place of Quick Keys for Systems or Sites.
- GRP: This icon appears with icons of Quick Key number for Channel Groups (1 - 9, 0).
- 1 - 9, 0: In SCAN mode, the numbers of unlocked Quick Key for Systems/Channel Group are displayed. The number for the currently scanned SQK set flashes.
- In SCAN HOLD mode, the Quick Key number for the current System/Channel Group appears.
- Enabled User Range numbers appear in Custom Search; the current range's number blinks.
- HOLD: This icon appears in Scan Hold, Search Hold and Close Call Hold Mode.
- L/O: This icon appears at a locked out Channel or frequency.
- PRI: This icon turns on during Priority Scan and this blinks during Priority Plus.
- GPS: This icon appears when the scanner receives GPS data. This shows in the same place as " ".
- AM / FM / NFM / FMB / WFM: These icons show the modulation type.
- ATT: This icon appears when a channel has attenuator on and blinks when global attenuator is on.
- P25: This icon shows the receiving digitalized voice of APCO P25.

- LNK:** This icon appears when data is received on a VOICE CHANNEL. This shows in the same place as "P25".
- DAT:** This icon appears when data on CONTROL CHANNEL is received. This shows in the same place as "P25" icon.
- ENC:** This icon appears when encrypted APCO P25 digitized voice is received. The scanner mutes audio. This shows in the same place as "P25".
- C67.0 / DCS023 / NAC:000 / etc.:** The scanner displays the CTCSS/DCS/P25 NAC here. This shows in the same place as "P25".
- SCR:** This icon appears when one or more Broadcast Screen Band is set to on.
- WX:** This icon turns on while the Weather Alert Priority Scan works.
- F (Function icon) :** This icon appears in Function Mode. Function Mode does not have a timeout when this icon blinks.
- P (Priority Channel) :** This icon appears when the channel set to "Priority On".
- 📶 (Signal Indicator) :** This icon shows strength of the signal from 0 to 5.
- 🔒 (KEYPAD LOCK):** This icon will appear only when the KEYLOCK function is On.
- 🔋 (BATTERY Low Alert):** This icon blinks when the battery voltage is low. This icon blinks when a bad battery is installed and an AC adapter is connected. This icon appears during battery check.
- 📶 (Close Call Pri) :** This icon appears in Close Call Priority Mode. This blinks in Close Call Only Mode or when the scanner gets a Close Call hit.
- 📶 (Close Call DND) :** This icon appears in Close Call DND Mode is CC DND Mode. This is a reverse display of Close Call Pri icon.

Dot Matrix

The display element consists of a 128 x 64 pixel display. See Font Data for character patterns.

Since the display is entirely dot matrix, a great variety of different things can be shown. The above shows the most common display elements in most modes. Additional examples are shown throughout this reference guide.

LCD Flashing Time

About 500 mS on/500 mS off (1 Hz).

Tones

The scanner can produce 3 fundamental tones, high (1200 Hz), middle (920 Hz), and low (640 Hz). Furthermore, there are Alert Tones and Weather Alert Sirens which include other sounds.

Additionally, special alert tones (Location Alert, CC alert, Emergency alert and WX alert, etc) can be set to custom volume levels.

General Tones

Key Touch Tone

When you press valid keys, the scanner will sound single high beep for 50 ms.

Confirmation Tone

The scanner will sound double high beep for confirmation (50 ms beep - 100 ms silent - 50 ms beep).

Exec Tone

When you press [E / yes / gps] key etc. to accept the entry or setting, the scanner will sound high-middle beep (75 ms high beep - 25 ms silent - 75 ms middle beep).

Error Tone

When you press a key that does not have a valid function in the current mode, the scanner will sound a triple low beep (75 ms beep - 25 ms silent -- repeat 2 times)

Weather Alert Sirens

The scanner sounds the following tones until any key is pressed, or for 8 seconds.

For Warning

[100 ms 120 Hz - (20 ms every 150 - 195 Hz in 5 Hz step) - (30 ms every 200 - 590 Hz in 10 Hz step) - 500 ms 600 Hz - 100 ms silent] --- repeat

For Watch

[(50 ms 800 Hz - 30 ms silent - 50 ms 1050 Hz - 30 ms silent) -- repeat 3 times - 170 ms silent] --- repeat

For Advisory

[100 ms 800 Hz - 50 ms silent - 100 ms 1050 Hz - 500 ms silent] -- repeat

For Weather Alert Tone: Same as Weather Alert Siren For Warning.

Tones in Menu Mode

Selecting a menu item

As you step to the next menu item by turning [Scroll Control] knob, the scanner will sound a single high beep for 100 ms.

However, if the menu item is the last item and you turn [Scroll Control] knob in the clockwise direction, the scanner will sound a double high beep (75 ms beep - 25 ms silent - 75 ms beep).

When you select a menu item by pressing [E / yes / gps] key, the scanner will sound a single middle beep for 100 ms.

Or, when you return to a previous menu by pressing [MENU] key, the scanner will sound a double middle beep (75 ms beep - 25 ms silent - 75 ms beep).

Editing a name or a frequency etc

When you select letters, the scanner sounds a single high beep for every click of the [Scroll Control] knob.

When you move the cursor from the left to the right, the scanner will sound a single middle beep (100 ms).

Or, when you move the cursor from the right to the left, the scanner will sound a double middle beep (75 ms beep - 25 ms silent - 75 ms beep).

If you store data by pressing [E / yes / gps], the scanner sounds the Exec Tone.

Alert in Scanner Mode

You can select channel or frequency alert from Alert1-9 in Menu by "Set Alert" and "Emergency Alert".

Each alert has a unique pattern of tones.

Alert in GPS Mode

Alert for Point Of Interest

You can select a location alert from Alert 1 to Alert 4 in Menu. Each alert provides a unique pattern of tones.

Alert for Dangerous Xing

The alert for Dangerous Xing is a fixed three-tone sequence.

Alert for Dangerous Road

The alert for Dangerous Road is a fixed five-tone sequence.

Battery Low Tone

At the low battery voltage level, the scanner will sound a single low beep (100 ms) every 15 seconds.

Operation

NOTE: Valid keys for the "Press Any Key" prompt are all keys except for [🔦 / 🔌 / 🔑]. Pressing [🔦 / 🔌 / 🔑] always turns on or off the backlight. And specially, pressing [L/O] cancels the prompt and exit from any Menu and so on immediately.

Power On

Press [🔦 / 🔌 / 🔑] for 1 second to turn on the scanner.

The scanner displays the opening screen and the copyright notice, and finally goes to the LAST MODE. The last select GPS Display mode is also backed up.

Notes on the Last Mode:

- LAST MODE means the mode when the scanner is turned off. It resumes Scan Mode, Custom/Service/Quick Search Mode, Weather Mode, Close Call Only, Tone-Out Mode, each Hold Mode, GPS Mode and Band Scope Mode for LAST MODE.
- In ID Search Hold Mode if ID has already been registered, LAST MODE will be ID Search Hold Mode. If ID has not been registered yet, LAST MODE will be Scan Mode.
- Review Location Mode is set to normal Scanner Mode (not GPS Mode).

```
Uniden Bearcat  
BCD396XT  
Digital Trunking  
Dynamic Scanning
```

Opening Screen

```
Copyright 2009  
Uniden America  
Corp. ALL Rights  
Reserved.
```

Copyright Notice Screen

Volume and Squelch Control

Volume and Squelch can be adjusted by rotating the [Scroll Control] in the following modes: Scan Mode, Scan Hold Mode, Search Mode, Search Hold Mode, Tone-Out Mode, Weather Scan Mode, Close Call Only Mode, Band Scope Mode, Band Scope Hold Mode.

Volume Adjust Mode

To adjust the volume level, press [Scroll Control]. When the volume level indicator appears, rotate [Scroll Control] to change the volume level.

You can set the volume level from 0 to 15.

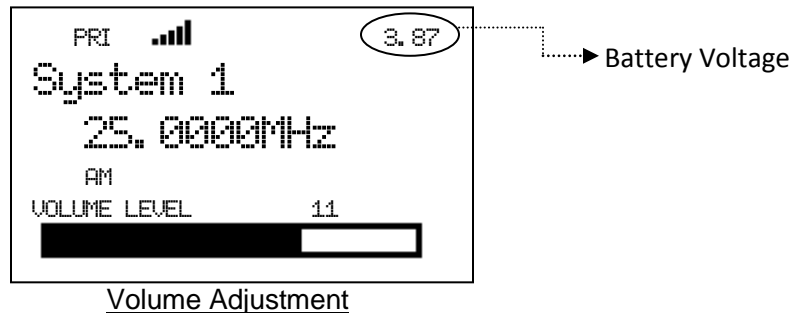

Press [Scroll Control] again or wait for 10 seconds to quit from the volume level control mode.

Press [Function] + [Scroll Control] to enter the P25 Condition Mode.

Squelch Adjust Mode

To adjust the squelch level, press [Function] + [Scroll Control]. When the squelch level indicator appears, rotate [Scroll Control] to change the squelch level.

The squelch level can set from 0 to 15.

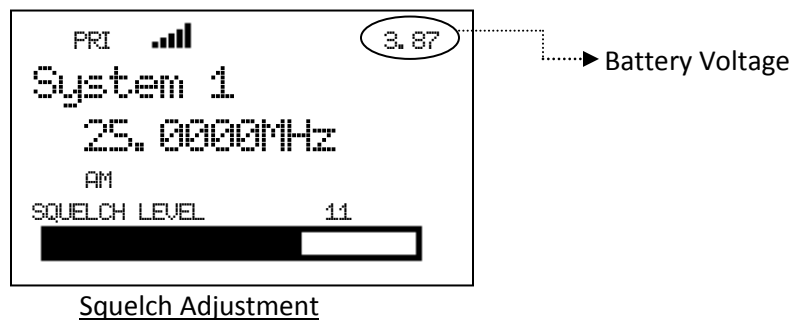

Press [Scroll Control] key again or wait for 10 seconds to quit from the squelch level control mode.

Press [Function] + [Scroll Control] key to enter the P25 Condition Mode.

P25 Condition Mode

Press [Function] + [Scroll Control] key to go to P25 Condition mode in Volume / Squelch Adjust mode.

You can see the current status of APCO decoding and the threshold values in this mode.

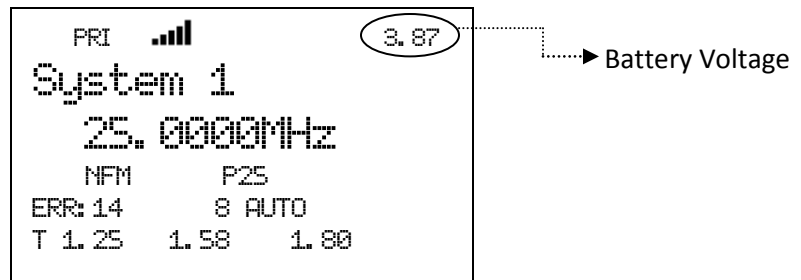

P25 Condition

T 1.25 1.58 1.80 indicates the threshold voltage. The specific values will be determined by your setup.

The number following ERR: indicates the APCO decoder error rate.

This number preceding AUTO shows threshold value.

Press [Scroll Control] key or [Function] + [Scroll Control] key to quit the P25 Condition Mode. This mode doesn't have a time-out.

State Transition Diagram

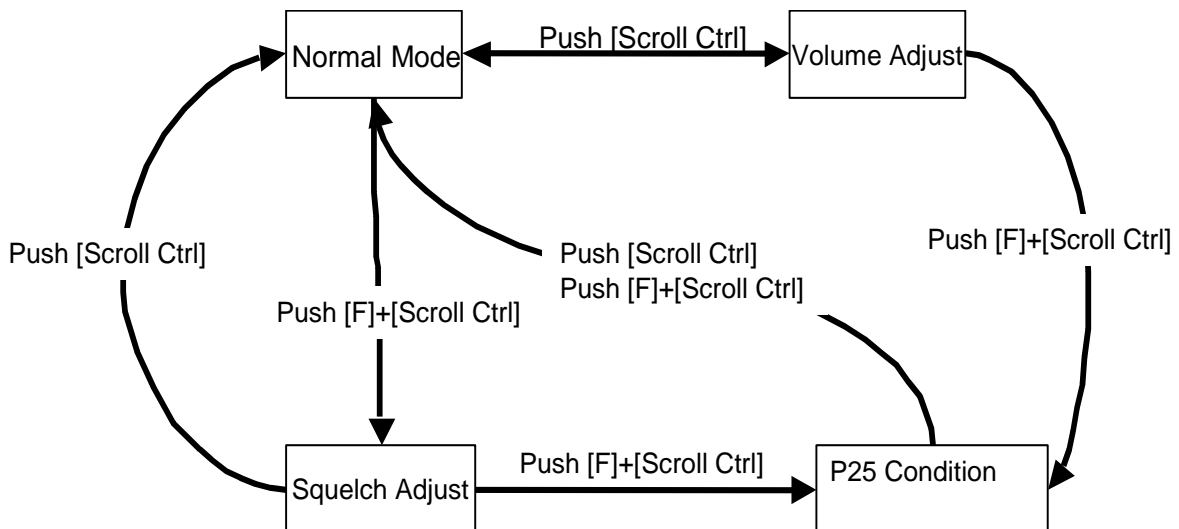

Menu Mode

General Operations

Key Operation

To enter the Menu Mode: Press [Menu]

To select a Menu item: Turn [Scroll Control]

To select a Menu item or input data: Press [E / yes / gps] or tap the [Scroll Control]

To Return to the previous: Press [Menu]

To exit from Menu Mode:

- ➔ Press [Scan / srch] to go to Scan Mode
- ➔ Press [Hold / - ➔ Press [Menu] at Top Menu to return to previous mode
- ➔ Press [L/O] to exit Menu and return to previous mode

Notes:

- Tapping the [Scroll Control] can be used instead of [E / yes / gps] in Menu Mode or at various prompts.
- NEXT item is a lower item in this document. Therefore, the next item of the lowest Item is highest item.
- Menu items are described as the bold letter in this specification.

Display Format in Menu Mode

The Menu Item screen is four-line mode.

The first line displays the Menu Item Name and the selection items are displayed below.

For example, the Menu display of a channel modulation setting is as follows.



Select an item by turning [Scroll Control] until the item is highlighted, then pressing [E / yes / gps].

Edit Name

The editing cursor is displayed. Turn [Scroll Control] to choose the character and the cursor stays at the highlighted position. The display is the following.

```
Edit Name
System 1      C
4 ← cursor → 6
```

Press [4 / LEFT / ifx] to move the cursor to the left and [6 / RIGHT / disp] to move it to the right.

Press [. / no / pri] once to erase one character with the cursor. Press it twice to erase all characters.

If the inputted name exists already in the same category, the scanner beeps Confirmation Tone and displays "Name Exists" and "Accept? (Y/N)".

By "Same category" we mean:

- A system name is the same as a service search range name, custom search range name or other system name.
- A group name is the same as another group name in the same system.
- A channel name is the same as another channel name in the same group.
- A custom search range name is the same as a system name, service search range name or other custom search range name.
- A SAME name is the same as another SAME name.
- A Tone-Out name is the same as another Tone-Out name.

```
Name Exists
Accept? (Y/N)
```

Press [E / yes / gps] to ignore the message and set the name. Then it proceeds to next step.

Press [. / no / pri] to return to the name editing state.

Note: If the user name has no character, the scanner prompts "Set Default Name" and "OK? (Y/N)".

```
Set Default Name
OK? (Y/N)
```

Press [E / yes / gps] to set Name to the default name. Press [. / no / pri] to return to name editing.

Edit Frequency and Set Tone

The editing cursor is displayed.

Press a number key to enter each digit and press the decimal key to input a decimal point.

The cursor moves to the left or the right by turning [Scroll Control] knob.

If you press the decimal key when a decimal point is already entered, the frequency data is cleared and the editing cursor moves to the first position.

The stored frequency is determined by the following:

- The entered frequency is stored if it can be divided by a valid step.
- If it cannot be divided by a valid step, the scanner stores the nearer frequency at a frequency of 5kHz step or a frequency of 6.25kHz step. So, you must input the correct frequency to store a frequency of 7.5 kHz step or 8.33 kHz step. (See: Band Coverage)

If the frequency is out of the range in Band Coverage, the scanner displays "Out of Band", "Press Any Key" and sounds an Error Tone. Press any key to return to editing mode.

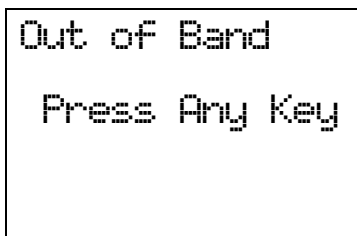

Out of Band
Press Any Key

For Channel Frequencies in conventional System, if the entered frequency is already stored into the same Group, it displays "Frequency Exists" "Accept? (Y/N)" and sounds a Confirmation Tone. Press [E / yes / gps] to ignore message and proceed to next step. Or press [. / no / pri] to return to the editing mode.

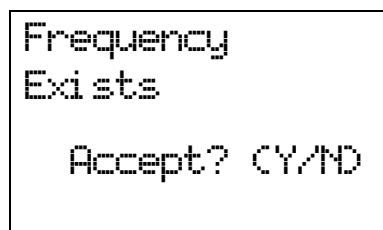

Frequency
Exists
Accept? (Y/N)

Edit Talk Group ID

Decimal TGID edit

The editing cursor is displayed.

Press a number key to enter the TGID and press the decimal key to enter a hyphen. The cursor moves to the right by entering a number or hyphen.

Press the decimal key first to set "i" for I-Call entries. Then press the number keys to enter the I-Call ID.

Turn the [Scroll Control] to move the cursor position from left end to next to right end character, or from left end to right end character when you have already entered the maximum length.

Hexadecimal TGID edit

Turn the [Scroll Control] to select Hexadecimal characters from “0” to “F”,

Press [4 / LEFT / ifx] to move the cursor left or press [6 / RIGHT / disp] to move cursor right.

Press [E / yes / gps] to set the Hex ID.

Note: You can change the TGID format in *Set ID Format (DEC/HEX)*

If you press the decimal key when there are already an acceptable number of hyphens, the TGID is cleared and the editing cursor moves to the first position.

Note: For details of TGID formats, please see: *TGID FORMAT FOR TRUNKED SYSTEM.*

If the entered TGID is invalid, the scanner beeps an Error Tone and displays "Bad TGID".

Press any key to return to the editing mode.

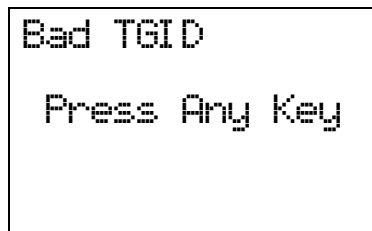

Notice of Location Data Input

Use WGS84 (World Geodetic System 1984) for latitude and longitude input.

The acceptable range of latitude and longitude is as follows.

- Latitude : 90°00'00.00 S - 00°00'00.00 N - 90°00'00.00 N
- Longitude : 180°00'00.00 E - 000°00'00.00 W - 180°00'00.00 W

The actual navigation distance may differ from the calculated one when a latitude exceeding 85 degrees (either North or South) is used.

Error Messages

If the scanner tries to create a new System/Location/Site/Group/Channel/TGID when it is already at the limit of System/Group/Channel, it displays “Over Limit”. (See: Memory Architecture)

If the scanner tries to create a new System/Location/Site/Group/Channel/TGID when the memory is full, it displays “Memory Full”.

If the scanner tries to create a new System/Location/Site/Group/Channel/TGID when the memory is broken, it displays “Memory Error”. When the scanner displays this message, you must initialize the memory by pressing [2 / sr2] + [9 / mod] + [Hold / 

Top Menu

Press [MENU] key to go to Menu Mode. Top Menu has the following items.

- Program System
- Program Location
- Srch/CloCall Opt
- Search for...
- Close Call
- Priority ID Scan
- WX Operation
- Tone-Out for ...
- Wired Clone
- Settings

Turn the [Scroll Control] to select items and press [E / yes / gps] to go to the selected item.

Press [Menu] to exit from Menu Mode.

Program System

You can select a System for editing or create a new System.

Names of existing Systems are displayed as Menu Items. These systems are sorted by the order in which they were created. "New System" is displayed as the last menu item.

Note: When no systems have been programmed, only "New System" appears.

The limit of Systems is 500. So, if you try to select "New System" when there are already 500 Systems, the scanner displays "Over Limit" and sounds an Error Tone. Then it returns to Top Menu.

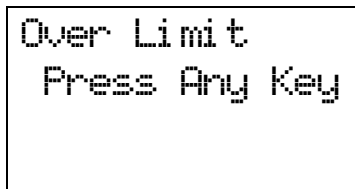

```
Over Limit
Press Any Key
```

Select the System Name and press [E / yes / gps] to go to the Systems Settings Menu. (See: System Settings)

If you select a protected system, "Protected System Access Not Allowed Press Any Key" is displayed and an Error Tone sounds.

Select "New System" and press [E / yes / gps] to create a new System.

Creating a New System

You can create up to 500 systems.

To create a new system, select the system type from the following items.

- P25 Select for P25 Standard Trunk or One-Freq system
- MOT Select for any Motorola Type system
- EDCS Select for EDACS WIDE/NARROW or EDACS SCAT system
- LT Select for an LTR system
- Conventional Select for a non-trunked system.

If you select a P25 type, you need to select more system type information from the following:

- Standard Trunk Select for a P25 Standard Trunk system
- One-Freq Trunk Select for a P25 One-Freq Trunk system

If you select an EDCS type, you need to select more system type information from the following:

- WIDE/NARROW Select for an EDACS WIDE/NARROW system
- SCAT Select for an EDACS SCAT system

Once you select the system type, the scanner prompts "Confirm?" and "Yes="E" / No="."".

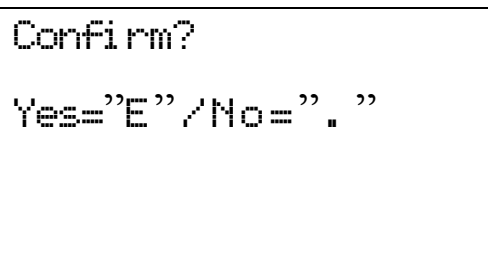

```
Confirm?  
Yes="E" / No="." "
```

Press [E / yes / gps] to confirm, and the system will be created.

Press [. / no / pri] to reject and return to the Menu of Select System.

When the System is created, the scanner assigns a default System name of "System xxx T" to the new System. (xxx: 1-3 digits sequential number / T: initial of type; P25="P", MOT="M", EDACS="E", LTR="L", Conventional="C"). Then, the scanner goes to Edit System Menu.

Note: Once a system has been created, the system type setting cannot be changed.

System Settings

This menu has the following items.

- Edit Name
- Edit Sys Option
- Edit Site
- Edit Group
- Copy System
- Delete System

These setting items are different for each System Type. See [System Settings](#) for details of the differences.

The first line displays the System name. For example, the following figure shows it is in settings of the System named "System 1 C".

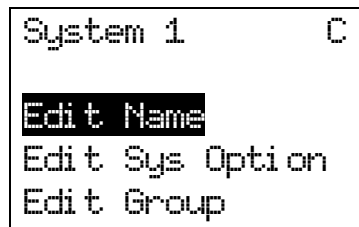

```
System 1      C
Edit Name
Edit Sys Option
Edit Group
```

Turn the [Scroll Control] and press [E / yes / gps] or tap the [Scroll Control] to go to each setting.

Edit Name

You can name the system. Refer to [FONT DATA](#) for the characters that can be entered.

Press [E / yes / gps] to accept the name entered. The scanner returns to the previous menu.

Edit Sys Option

You can change the following System settings.

- Set Quick Key
- Set Startup Key
- Set Number Tag
- Set Lockout
- Set Hold Time
- ID Scan/Search
- Set Delay Time
- Edit Fleet Map
- Priority ID Scan
- Set Status Bit
- Set End Code
- Emergency Alert
- Set ID Format (DEC/HEX)
- Set ID Format (AFS/DEC)
- Rvw ID: Srch L/O
- Clr All L/O IDs
- Set Audio AGC
- P25 Waiting Time
- P25 NAC Option

These setting items are different for each System Type. See [System Option](#) for details of the difference.

Press [E / yes / gps] to enter each setting.

Set Quick Key

This option allows you to select key that will rapidly lock/unlock the System when the scanner is Scan Mode. Turn the [Scroll Control] to select the Quick Key for the System. The Quick Key can be set from "0" to "99" and "." (= Not assigned).

Press a number key to jump the cursor to the head number of ten's place. For example if you press [2 / sr2], the cursor jumps to "20".

Press [E / yes / gps] to accept and return to the previous menu.

Note: The highest number of priority is Quick Key 1 and lowest number is Quick Key 90.

(See: [Scanning Order](#).)

Set Startup Key

The scanner locks or unlocks the system according to setting of this option by pressing and holding a number key at power-on or while displaying the Opening Screen.

Turn [Scroll Control] to select the Startup Key in this menu. The Startup Key can be set from "0" to "9" and "." (= Not assigned).

Press [E / yes / gps] to accept the selection and return to the previous menu.

Set Number Tag

The System Number Tag can be set in this menu.

Press a number key to input the number tag. Press [. / no / pri] to clear the input.

Press [E / yes / gps] to accept the setting and return to the previous menu.

Note: The valid setting range is from 0 to 999. Blank means a number tag not assigned.

Set Lockout

This option allows you to lock or unlock the current system. When the system is locked out, the scanner does not check it.

Unlocked	The system is unlocked.
Temporary L/O	The system is temporarily locked out.
Lockout	The system is locked out.

Press [E / yes / gps] to accept the selection and return to the previous menu.

Set Hold Time

This setting determines the minimum time the scanner is forced to hold and scan System Channels before moving to the next System, even if there is no traffic on the Channels. You can set it from 0 to 255 seconds by pressing a number key.

Press [E / yes / gps] to accept the entry and return to the previous menu.

If you enter over "255" for the Hold Time, the scanner prompts "Out of Range" and "Set Max? (Y/N)". When [E / yes / gps] is pushed, maximum value 255 will be set.

It returns to the edit state, if you press [. / no / pri].

Note: The scanner will check all unlocked Channels at least 1 time before moving to the next system, independent of whether the hold time has been set or not.

ID Scan/Search

This setting determines how the scanner scans trunked Systems.

ID Scan	The scanner only stops on TGIDs that have been programmed and not locked out.
ID Search	The scanner stops on any TGID that is not locked out.

Press [E / yes / gps] to set the setting and return to the previous menu.

Set Delay Time

This setting controls how long the scanner stays on a transmission before resuming scanning. If you select a positive value, the scanner will hold on the channel for that duration after the carrier drops before resuming scanning. If you select a negative value, the scanner will stay on a transmission until the carrier drops or until the selected time elapses, whichever is shortest.

Turn [Scroll Control] to select the delay time setting from the following list:

- 10 sec
- 5 sec
- 2 sec
- 0 sec
- 1 sec
- 2 sec
- 5 sec
- 10 sec
- 30 sec

Then press [E / yes / gps] to accept and return to the previous menu.

Edit Fleet Map

Motorola 800 Type I/Hybrid Systems require a Fleet Map that sets specific Fleet - SubFleet parameters. There are 16 preset Fleet Maps listed in [PRESET FLEET MAP](#) that you can choose, and these are usually a good place to start when setting up a Type I/Hybrid System. If you choose a preset map and still have difficulty following complete conversation, then you will have to program a Custom Fleet Map.

Note: A Hybrid System is simply a Type I System with some blocks designated as Type II blocks. Select Size Code 0 to treat the block as Type II and select others to treat as Type I.

You can select from "Preset" and "Custom".

- Preset
- Custom

Preset

If "Preset" is selected by pressing [E / yes / gps], you need to select from 16 preset Fleet Maps.

- Preset 1
- Preset 2
- :
- Preset 16

Press [E / yes / gps] to select one of the 16 preset Fleet Maps and return to the previous menu.

Custom

On the other hand, if "Custom" is selected, then you are prompted to enter the Fleet Map information.

You need to set Size Codes to all Blocks in order.

There are 8 Blocks from "Block 0" to "Block 7" and 15 Size Codes from "Size Code 0" to "Size Code 14".

In this selection, first Line displays the Block number and after second lines displays the Size Code.

```
Size Code 0
Size Code 1
Size Code 2
:
Size Code 14
```

Turn [Scroll Control] to select the Size Code. Press [E / yes / gps] to set the Size Code and proceed to the next Block setting. And press [Menu] to go back to the previous one.

Press [E / yes / gps] at the last Block to return to the previous menu with the current selection.

Press [Menu] at Block 0 to return to the previous menu. However, Size Codes once selected by pressing [E / yes / gps] are not canceled.

Motorola 800 Type I and Type II:

Select Custom and set all blocks to Size Code 0. The scanner treats this System as Motorola Type II. In other cases, it treats the System as Motorola Type I.

Note: If you change the Fleet Map setting, the ID display format will also change.

Priority ID Scan

This setting controls how the scanner treats Priority IDs.

You can select the following items.

On	The scanner scans all unlocked IDs and also checks Priority IDs.
Off	The scanner provides no special treatment for Priority IDs.

Press [E / yes / gps] to accept the selection and return to the previous menu.

Set Status Bit

This setting determines how the scanner treats the status bits.

Yes	The scanner pays attention to the status bits in the TGID.
Ignore	The scanner ignores status bits in the TGID.

Press [E / yes / gps] to accept the entry and return to the previous menu.

Set End Code

This setting determines how the scanner treats the transmission end code.

- Analog The scanner pays attention to the analog transmission end code.
- Analog+Digital The scanner pays attention to both analog and digital transmission end code
- Ignore The scanner ignores the transmission end code and waits for carrier drop.

Press [E / yes / gps] to accept the selection and return to the previous menu.

Emergency Alert

The following options can be set in this menu.

- Set Alert Tone
- Set Alert Light

Press [E / yes / gps] to enter the setting.

Set Alert Tone

If “Set Alert Tone” is selected, user can determine how the scanner treats the Talk Group that set with emergency flag.

- Off The scanner ignores the emergency flag.
- Alert1-9 The scanner sounds the Emergency Alert Tone when any Talk Group goes active with the emergency flag set.

When you select “Off”, the scanner returns to the previous menu.

When you select “Alert1-9”, the scanner goes to the Alert Level selection.

- Auto The alert is set to the same volume as normal audio.
- Level1-15 The alert is fixed to the selected audio level.

Press [E / yes / gps] to accept the entry and return to the previous menu.

Set Alert Light

If "Set Alert Light" is selected, you can select from the following alert colors:

- Off
- Blue
- Red
- Magenta
- Green
- Cyan
- Yellow
- White

If you select "Off", the scanner returns to the previous menu.

If you select an alert light color, the scanner goes to the Alert Light Pattern selection.

On	The alert light is set to on
Slow Blink	The alert light blinks slowly
Fast Blink	The alert light blinks fast

Press [E / yes / gps] to accept the entry and return to the previous menu.

Set ID Format (DEC/HEX)

You can select the format for TGIDs on P25 and MOT type system.

Decimal Format	The scanner uses decimal format for TGIDs.
Hex Format	The scanner uses hexadecimal format for TGIDs.

Press [E / yes / gps] to accept the entry and return to the previous menu.

Set ID Format (AFS/DEC)

You can select the format for TGIDs on EDACS WIDE/NARROW systems.

AFS Format	The scanner uses AFS format for TGIDs.
Decimal Format	The scanner uses decimal format for TGIDs.

Press [E / yes / gps] to accept the entry and return to the previous menu.

Rvw ID:Srch L/O

Allows you to review TGIDs that are locked out in ID Search or ID Scan. Any TalkGroup in this list will be skipped if encountered in ID Search or ID Scan.

This option displays "temporarily L/O IDs" and "permanently L/O IDs" without distinction.

The first Line displays "Unlock?(Y/N)" and other lines display TGIDs that are locked out. Turn the [Scroll Control] to choose TGIDs.

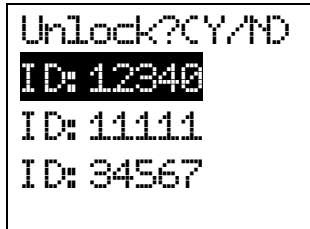

```
Unlock?(Y/N)
ID: 12340
ID: 11111
ID: 34567
```

Press [E / yes / gps] to unlock the TGID.

Press [. / no / pri] to advance to the next locked TGID.

Press [Menu] to return the previous menu.

If no TGIDs have been locked, the scanner displays "Nothing Locked". Press any key to return to the previous menu.

If all TGIDs are unlocked, it displays "Nothing Locked". Press any key to return to the previous menu.

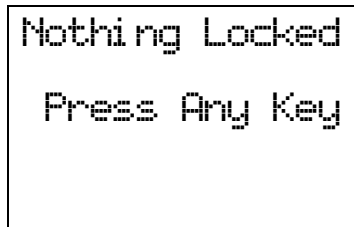

```
Nothing Locked
Press Any Key
```

Clr All L/O IDs

Selecting this causes the scanner to prompt "Confirm ?" and "Unlock All(Y/N)".

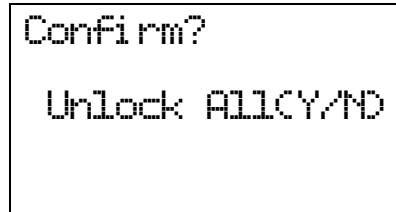

```
Confirm?  
Unlock ALL(Y/N)
```

Press [E / yes / gps] to unlock all TGIDs.

Press [. / no / pri] to cancel this selection.

The scanner returns to the previous menu.

If all TGIDs are unlocked, it displays "Nothing Locked". Then press any key to return to previous menu.

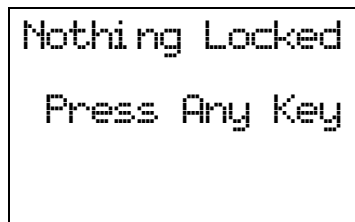

```
Nothing Locked  
Press Any Key
```

Set Audio AGC

When Audio AGC function is "On", the scanner judges the volume level and changes the volume automatically.

You can turn either Analog or Digital audio "On" or "Off".

Analog : On / Off

Digital : On / Off

On Audio AGC is on.

Off Audio AGC is off.

Turn [Scroll Control] to focus the cursor on the item. Press [E / yes / gps] to change the setting on / off and press [Menu] to return to the previous menu.

P25 Waiting Time

The feature is used to set a wait time for P25 decode. After receive a transmission the scanner will wait for the set duration to check if there is any P25 signal.

Selectable waiting times are:

- 0 ms
- 100 ms
- 200 ms
- 300 ms
- 400 ms
- 500 ms
- 600 ms
- 700 ms
- 800 ms
- 900 ms
- 1000 ms

Press [E / yes / gps] to accept the selection and return to the previous menu.

P25 NAC Option

This menu is used to set P25 NAC (Network Access Code) option for the P25 One-Freq Trunk systems. You can select from the following items.

- Search The scanner search for all the P25 NAC.
- Set P25 NAC The scanner uses the programmed P25 NAC

When you select "Search":

The scanner returns to the previous menu.

When you select "Set P25 NAC":

Press the number key to enter P25 NAC, valid range is from 0 to FFF hex.

Press [E / yes / gps] to set and return to the previous menu.

If out of range, the message "Out of Range" and "Press Any Key" will be shown with error tone.

Edit Site

See *Program Site*.

Edit Group

See *Program Group*.

Copy System

You can copy the System and all associated settings by select this menu item. The scanner prompts you for a new System Name.

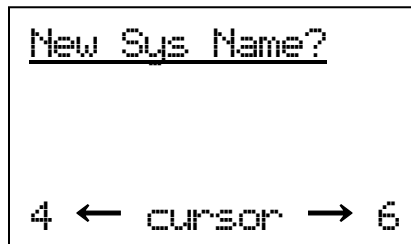

Press [E / yes / gps] to copy the System with the entered System name. The scanner goes to the System Settings menu with the new System active.

Note: This operation also copies all sites, Groups and Channels belonging to the System.

Delete System

You can delete the current system and all associated settings by select this menu item. The scanner prompts "Confirm Delete?" to confirm deletion.

Press [E / yes / gps] to delete the current system.

Press [. / no / pri] to cancel deletion and return to the previous menu.

Note: If you confirm to delete the system, all site, all Groups and all Channel data belonging to the System are also deleted.

Program Site

You can select an existing Site for editing or create a new Site. Site Names that already have been created are displayed as Menu Items.

Sites are sorted in the order of the Site Quick Key (See: [Set Quick Key](#)) as 1, 2,...,0,11,...99, 90 and not assigned. The order of Sites belonging to the same Quick Key is determined by the order in which they were created. "New Site" is displayed as the last menu item.

Select "New Site" and press [E / yes / gps] to create a new site.

Note: At first, only "New Site" is displayed.

The limit of Sites in a system is 256. So, if you try to select "New Site" when there are already 256 Sites, the scanner displays "Over Limit" and sounds an Error Tone.

Creating a New Site

Press [E / yes / gps] to create a new site. After a new site is created, the scanner assigns a default site name of "Site xxx-yyy TTT".

xxx: System index number,
yyy: 1-3 digit sequential site index number,
TTT: abbreviation for the site type, as follows.
MOT Type = "MOT"
EDACS WIDE/NARROW= "EDC"
LTR Type = "LTR"
P25 Standard Type = "P25"
P25 One-Freq Type = "1FQ"

Site Settings

The following site settings are possible:

- Edit Name
- Set Quick Key
- Set Startup Key
- Edit Band Plan (P25)
- Edit Band Plan (Mot)
- Set Site Type
- Set Frequencies
- Set Modulation
- Set Attenuator
- Set Lockout
- Set Hold Time
- Set C-Ch Only
- Set LocationInfo
- P25 Waiting Time
- Delete Site
- New Site

The items available are different for each Site Type. See [Site Settings](#) for details of the difference.

Turn [Scroll Control] knob and press [E / yes / gps] key to go to each setting.

Edit Name

You can name the site.

Refer to FONT DATA for the characters that can be entered.

Press [E / yes / gps] to accept the name entered. The scanner returns to the previous menu.

Set Quick Key

This option lets you select which Quick Key will rapidly lock/unlock the site in Scan Mode.

Turn [Scroll Control] to select the Site Quick Key. The Site Quick Key can be from "0" to "99" and "." (= Not assigned).

Press a number key to jump the cursor to the head number of ten's place. For example if you press [2 / sr2], the cursor jumps to "20".

Press [E / yes / gps] to accept and return to the previous menu.

Set Startup Key

The scanner locks or unlocks the system according to setting of this option by pressing and holding a number key at power-on or while displaying the Opening Screen.

Turn [Scroll Control] to select the Startup Key in this menu. The Startup Key can be set from "0" to "9" and "." (= Not assigned).

Press [E / yes / gps] to accept the selection and return to the previous menu.

Edit Band Plan (P25)

This setting menu is shown when the selected system is a P25 Standard Trunked system.

Usually, the scanner stores the plan automatically when it receives the plan from a repeater. Therefore, you do not have to set the plan in most systems. The plan must be set manually only when the repeater doesn't send the plan.

You can set 16 bands for a site. First, select the Band Plan number ("Select Plan") by turning the [Scroll Control]. The scanner displays the Band Plan number, the base frequency and the spacing frequency as "n:xxx.xxxxx/y.yy". (n : Band Plan number, xxx.xxxxx : the base frequency, y.yy : the space frequency)

Press [E / yes / gps] to select a band plan.

Input the base frequency ("Input Base Freq"). This frequency can be from 25.00000MHz to 1300.00000MHz at 5.0Hz steps. Press [E / yes / gps] to set the base frequency.

Set the space frequency ("Input Spacing"). You can input from 125Hz to 128.0kHz in 125Hz Steps. Press [E / yes / gps] to finish the band plan setting.

If you enter an out of range value for the base frequency, the scanner displays "Out of Band" and "Press Any Key" and sounds an Error Tone. Press any key to return to editing mode.

If you enter less than "125Hz", the scanner prompts "Out of Range" and "Set Min? (Y/N)". Press [E / yes / gps] to set the minimum spacing frequency (125Hz). Or, press [. / no / pri] to return to editing state.

If you enter over "128.0kHz", the scanner prompts "Out of Range" and "Set Max? (Y/N)". Press [E / yes / gps] to set the maximum spacing frequency (128.0kHz). Or, press [. / no / pri] to return to editing state.

Note: The scanner displays "n:-----/----" (n : Band Plan number) in Select Plan when the base frequency is "0MHz". It means the number is not used.

Edit Band Plan (Mot)

This menu is shown when the selected system is a MOT type system.

You can select one of three kinds of band plans:

- 800/900 Standard
- 800 Splinter
- Custom

To properly track Motorola VHF and UHF systems and rebanded 800 MHz systems, you should select "Custom" and enter what is known as the base frequencies (Lower and Upper), the spacing frequencies and channel offsets for each System.

To select the custom Band Plan number, turn the [Scroll Control] to select its number from 1 to 6.

- Band Plan 1
- Band Plan 2
- Band Plan 3
- Band Plan 4
- Band Plan 5
- Band Plan 6

Then press[E / yes / gps] is pressed. You are then prompted to set the detailed information of band plan.

- Set Base Freq
- Set Offset
- Set Spacing

When you select "Set Base Freq", you are then prompted to "Input Lower" then "Input Upper". Use the number keys and decimal key to input frequencies. Press [E / yes / gps] to set the frequency. If the entered frequency is out of band, "Out of Band" will be shown with an error tone. Press any key to go back to editing the base frequency.

When you select "Set Offset", you can set the channel offset for the band plan entry. You can set the Offset from -1023 to +1023. Enter the absolute value using the number keys. If you input a value over 1023, "Out of Range" and "Set Max? (Y/N)" will be shown. Press [. / no / pri] to return to editing state. Press [E / yes / gps] to set the value to maximum number (1023) and you will be prompted to "Select Polarity". Select "+ Polarity" or "- Polarity", then press [E / yes / gps] to confirm the setting.

When you select "Set Spacing", the following spacing values can be selected:

5.00 kHz	6.25 kHz	10.00 kHz	12.50 kHz	15.00 kHz
18.75 kHz	20.00 kHz	25.00 kHz	30.00 kHz	31.25 kHz
35.00 kHz	37.50 kHz	40.00 kHz	43.75 kHz	45.00 kHz
50.00 kHz	55.00 kHz	56.25 kHz	60.00 kHz	62.50 kHz
65.00 kHz	68.75 kHz	70.00 kHz	75.00 kHz	80.00 kHz
81.25 kHz	85.00 kHz	87.50 kHz	90.00 kHz	93.75 kHz
95.00 kHz	100.00 kHz			

Turn the [Scroll Control] to select. Press [E / yes / gps] to set the Spacing.

Note: If Base Freqs haven't been set yet, the setting of Offset and Spacing will not be accepted.

For rebanded systems, the most likely settings for Base (Lower and Upper), Offset and Spacing in the table are:

Band Plan	Base Freq (Lower)	Base Freq (Upper)	Offset	Polarity	Spacing
1	851.025MHz	854.000MHz	440	+	25 kHz
2	851.0125MHz	868.9875MHz	0	+	25 kHz

Set Site Type

You can select the site type for EDACS WIDE/NARROW system.

Wide(Standard)	EDACS wide site
Narrow	EDACS narrow site

Press [E / yes / gps] to accept and return to the previous menu.

Set Frequencies

You can select a stored frequency or enter a new system frequency.

Frequencies already set are displayed as a Menu Item and "New Frequency" is displayed as the last one.

For example, if you have stored "851.0125MHz" and "868.9875MHz", the selectable items are as follows:

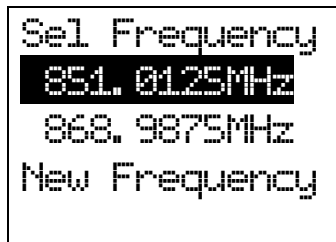

Note: At first, only "New Frequency" is displayed.

The limit of trunk frequencies in a site is 500 - 1000. You can store up to 1000 total TGID and trunk frequencies. When it is over the limit, the scanner sounds an Error Tone.

If "New Frequency" is selected by pressing [E / yes / gps], the scanner skips the next selection. Then it goes to Edit Frequency menu automatically to enter the frequency.

If you select a stored frequency and press [E / yes / gps], the scanner prompts for the next setting items.

- Edit Frequency
- Set Number Tag*
- Set Lockout
- Volume Offset (SCAT systems only)
- Delete Frequency
- New Frequency

Turn [Scroll Control] and press [E / yes / gps] to go to each setting.

*This setting is displayed only when the system type is "EDCS SCAT".

Edit Frequency

You can enter or edit the frequency by pressing the number keys and decimal key.

Press [E / yes / gps] to store the frequency.

The scanner does not allow frequency duplication in a System. If the entered frequency is already stored into that System, the scanner sounds an Error Tone and displays "Frequency Exists".

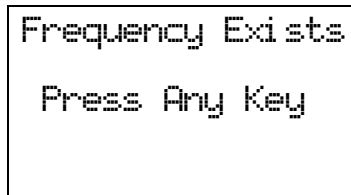

Then press any key to return to the editing mode.

Valid frequency ranges are in Band Coverage. If the entered frequency is out of range, the scanner sounds an Error Tone and displays "Out of Band". And the scanner stays on this state.

If the type of System is EDACS WIDE/NARROW or LTR, the scanner prompts for a LCN (logical channel number). Press [0 - 9] to enter the LCN.

Note: You can only enter the LCN suitable for each System type. EDACS: 1-30, LTR: 1-20.

Press [E / yes / gps] to store the LCN and return to the previous menu. The scanner does not allow LCN duplication in a System. If the entered LCN is already stored, the scanner sounds an Error Tone and displays "LCN Exists".

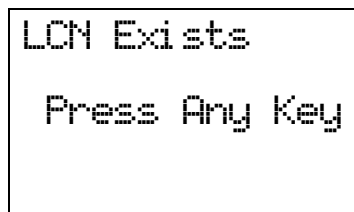

Set Number Tag

The channel Number Tag can be set in this menu.

Press a number key to input the number tag. Press [./no/pri] to clear the input.

Press [E/yes/gps] to accept the setting and return to the previous menu.

Note: The valid setting range is from 0 to 999. Blank means a number tag not assigned.

This option is only shown when system type is EDACS SCAT.

Set Lockout

This option allows you to lock or unlock the current system. When the system is locked out, the scanner does not check it.

Unlocked	The system is unlocked.
Temporary L/O	The system is temporarily locked out.
Lockout	The system is locked out.

Press [E/yes/gps] to accept the selection and return to the previous menu.

Volume Offset (SCAT systems only)

This option is used to set a volume offset for each site frequency. The feature can let you adjust the volume level relative to other channels when the frequency is active. Setting level are:

- 3
- 2
- 1
- 0
- +1
- +2
- +3

Press [E/yes/gps] to accept the selection and return to the previous menu.

Delete Frequency

You can delete the current frequency and all associated settings by selecting this menu item. The scanner prompts "Confirm Delete?" to confirm deletion.

Press [E/yes/gps] to delete the current frequency.

Press [./no/pri] to cancel deletion and return to the previous menu.

New Frequency

Press [E/yes/gps] to create a new frequency and go to Set Frequencies.

Set Modulation

You can select the modulation from following settings.

- Auto* The scanner uses the modulation normal for the frequency's band.
- NFM The scanner uses Narrowband FM demodulation.
- FM The scanner uses FM demodulation.

Press [E / yes / gps] to accept the entry and return to the previous menu.

*If the system type is "MOT", "LT" or "EDCS SCAT", when the default modulation of the frequency in Band Defaults is not FM or NFM, the scanner will operate as FM.

Set Attenuator

You can attenuate RF reception on the frequency.

- On The frequency will be attenuated.
- Off The frequency will not be attenuated.

Press [E / yes / gps] to accept the selection and return to the previous menu.

Set Lockout

This option allows you to lock or unlock the current system. When the system is locked out, the scanner does not check it.

- Unlocked The system is unlocked.
- Temporary L/O The system is temporarily locked out.
- Lockout The system is locked out.

Press [E / yes / gps] to accept the selection and return to the previous menu.

Set Hold Time

In Trunked Systems, this setting is applied only when a Control Channel can be received.

If no Control Channel can be received, the scanner goes to the next system immediately.

You change this setting from 0 to 255 seconds by pressing the number keys.

Press [E / yes / gps] to accept the entry and return to the previous menu.

If you enter over "255" for the Hold Time, the scanner prompts "Out of Range" and "Set Max? (Y/N)".
When [E / yes / gps] is pushed, maximum value 255 will be set.

It returns to the edit state, if you press [. / no / pri].

Set C-Ch Only

You can select how the scanner tracks Motorola Systems. (C-Ch means control channel.)

- On The scanner can track Motorola System by entering only the system control channels. You will not have to program the voice channels.
- Off You need to enter the control channel and voice channels.

Press [E / yes / gps] to accept the entry and return to the previous menu.

Set LocationInfo

You can set the location data for the current site.

The setting items are:

- Set Latitude
- Set Longitude
- Set Range
- Set GPS Enable

Turn [Scroll Control] to select the item and Press [E / yes / gps] to go to the settings.

Set Latitude

Press the number keys to enter latitude data. Press any number key when the cursor is in the last position to toggle between south latitude (S) and the north latitude (N).

Press [E / yes / gps] to accept and return to the previous menu.

If "DMS:DDD⁰MM'SS.ss" is selected in Set Pos Format, the display is the following.

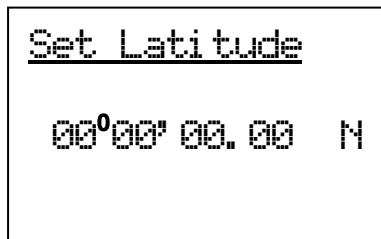

If "DEG:DDD.dddddd" is selected in Set Pos Format, the display is the following.

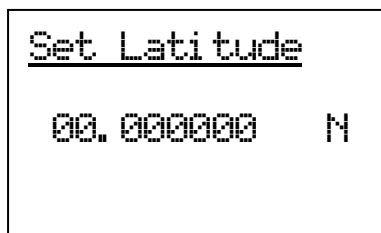

Set Longitude

Press the number keys to enter longitude data. Press any number key when the cursor is in the last position to toggle between east longitude (E) and west longitude (W).

Press [E / yes / gps] to accept and return to the previous menu.

If “DMS:DDD°MM'SS.ss” is selected in Set Pos Format, the display is the following.

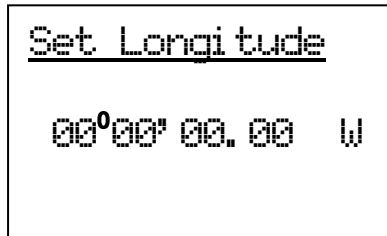

The screenshot shows a monochrome LCD display with the text "Set Longitude" at the top. Below it, the display shows "00°00' 00.00 W".

If “DEG:DDD.dddddd” is selected in Set Pos Format, the display is the following.

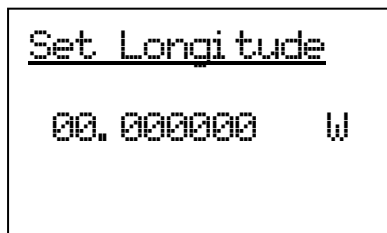

The screenshot shows a monochrome LCD display with the text "Set Longitude" at the top. Below it, the display shows "00.000000 W".

Set Range

In this menu, the setting unit is determined by the setting in Set Unit.

When you select “mile” in Set Unit, the displayed unit will be mile.

When you select “km” in Set Unit, the displayed unit will be km.

The valid setting range is from 0.5 to 125.0, in 0.5 steps.

Press [E / yes / gps] to accept the setting and return to the previous menu.

Set GPS Enable

When this option is set to “On”, the scanner will control L/O status of this site by position information received from a GPS.

On The L/O state of this site is automatically controlled by position information.

Off The L/O state of this site is not influenced by GPS.

Press [E / yes / gps] to accept and return to the previous menu.

P25 Waiting Time

The feature is used to set a wait time for P25 decode. After receive a transmission the scanner will wait for the set duration to check if there is any P25 signal.

Selectable waiting times are:

- 0 ms
- 100 ms
- 200 ms
- 300 ms
- 400 ms
- 500 ms
- 600 ms
- 700 ms
- 800 ms
- 900 ms
- 1000 ms

Press [E / yes / gps] to accept the selection and return to the previous menu.

Delete Site

You can delete the current site and all associated settings by select this menu item. The scanner prompts "Confirm Delete?" to confirm deletion.

Press [E / yes / gps] to delete the current site.

Press [. / no / pri] to cancel deletion and return to the previous menu.

New Site

Press [E / yes / gps] to create a New Site and goes to *Creating a New Site*.

Program Group

This menu lets you select a Channel Group for programming or create a new Channel Group.

Names of Groups already created are displayed as Menu Items. The order of Groups is sorted by setting of Quick Key for Groups (See: [Set Quick Key](#)) as 1, 2, 3, ... , 9, 0 and "." (=Not assigned). The order of Groups belonging to same Quick Key is determined by the assigned order. "New Group" is displayed as the last item.

For example, there are two groups named "Group 1" and "Group 2", selectable items are as follows:

- Group 1
- Group 2
- New Group

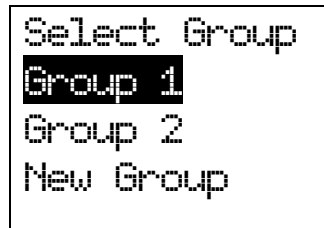

Note: At first, only "New Group" is displayed.

The limit of Groups in a System is 20. So, if you try to select "New Group" when there are already 20 Groups in that System, the scanner displays "Over Limit" and sounds an Error Tone. Then it returns to Group selection.

Select the Group Name or "New Group" and press [E / yes / gps] to go to the Group Settings Menu.

If the "New Group" is selected, the scanner appends a Group to the System with a default Group name of "Group xx". (xx: 1-2 digits sequential number)

Group Settings

This menu has following group settings:

- Edit Name
- Set Quick Key
- Edit Channel
- Set LocationInfo
- Set Lockout
- Delete Group
- New Group

Note: The name of the Group will be shown in the first line of the display.

Press [E / yes / gps] to go to each setting.

Edit Name

Here, you can name the Channel Group.

Refer to FONT DATA for the characters that can be entered.

Press [E / yes / gps] to accept the name entered. The scanner returns to the previous menu.

Set Quick Key

This option lets you select which Group Quick Key will rapidly enable/disable the Group when the scanner is in the scanning mode.

Allowed settings are from 0 to 9 and not assigned. You can assign more than one Channel Group to the same Quick Key.

Press [1 – 9, 0] to assign each number as a Group Quick Key.

Press [. / no / pri] to assign to no Group Quick Key.

Press [E / yes / gps] to accept and return to the previous menu.

Edit Channel

See: *Program Channel*.

Set LocationInfo

You can set location data for the current channel group so it is automatically locked and unlocked as you change location (when using an external GPS).

You set the following items:

- Set Latitude
- Set Longitude
- Set Range
- Set GPS Enable

Turn [Scroll Control] to select an item to set and press [E / yes / gps] to go to the settings.

Set Latitude

Enter the latitude data using the number keys.

Press any number key when the cursor is in the last position to toggle between south latitude (S) and north latitude (N).

Then press [E / yes / gps] to accept and return to the previous menu.

If “DMS:DDD⁰ MM’SS.ss” is
display is the following.

selected in *Set Pos Format*, the

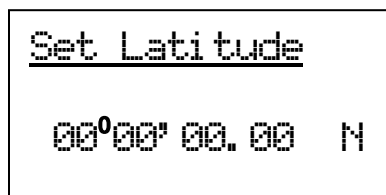

If “DEG:DDD.dddddd” is selected in Set Pos Format, the display is the following.

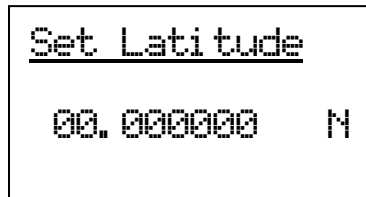

Set Longitude

Enter the longitude data using the number keys.

Press any number key when the cursor is in the last position to toggle between west longitude (W) and east longitude (E).

Then press [E / yes / gps] to accept and return to the previous menu.

If “DMS:DDD°MM'SS.ss” is selected in Set Pos Format, the display is the following.

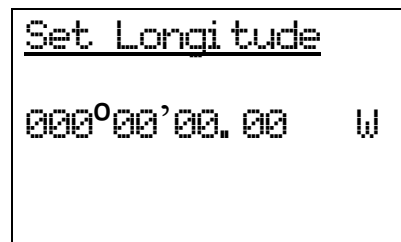

If “DEG:DDD.dddddd” is selected in Set Pos Format, the display is the following.

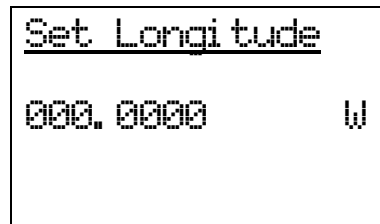

Set Range

In this menu, the setting unit depends on the setting in Set Unit.

When you select “mile” in Set Unit, the displayed unit is mile.

When you select “km” in Set Unit, the displayed unit is km.

The valid setting range is from 0.5 to 125.0 in 0.5 steps.

Press [E / yes / gps] to accept the setting and return to the previous menu.

Set GPS Enable

When this option is set to "On", the scanner will control the L/O status of this channel group using position information supplied from a connected GPS.

- On The Channel Group's L/O state is automatically controlled by position information.
- Off The Channel Group's L/O state is not influenced by GPS.

Press [E / yes / gps] to accept and return to the previous menu.

Set Lockout

This option allows you to lock or unlock the current channel group. When the channel group is locked out, the scanner does not check it.

- Unlocked The channel group is unlocked.
- Temporary L/O The channel group is temporarily locked out.
- Lockout The channel group is locked out.

Press [E / yes / gps] to accept the selection and return to the previous menu.

Delete Group

You can delete the current channel group and all associated settings by select this menu item. The scanner prompts "Confirm Delete?" to confirm deletion.

Press [E / yes / gps] to delete the current channel group.

Press [. / no / pri] to cancel deletion and return to the previous menu.

New Group

Press [E / yes / gps] to create a new group and go to Group Settings.

Program Channel

You can select a Channel for programming or add a new Channel.

Names of Channels already added are displayed as Menu Items. The order of Channels is sorted by created or pasted order. "New Channel" is displayed as the next to last Channel. "Paste Channel" will be displayed as the last item if a Channel has previously been copied from a compatible (same typed) System / Site.

For example, there are the Channel named "Channel A" and a Channel was copied, selectable items are as follows:

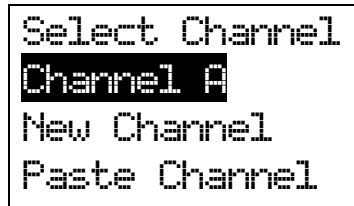

Note: At first, only "New Channel" is displayed.

For conventional systems, the limit of Channels for one system is 1000. So, if you select "New Channel" and enter a frequency when there are already 1000 channels in the system, the scanner displays "Over Limit" and sounds an Error Tone. Then it returns to channel selection.

For trunked Systems, the limit of Channels for one system is 500. So, if you select "New Channel" and enter a TGID when there are already 500 Channels in the system, the scanner displays "Over Limit" and sounds an Error Tone. Then it returns to Channel selection.

The limit of Channels and System frequencies is 25000. If you select "New Channel" and enter the frequency or TGID when there are already 25000 Channels and System frequencies, the scanner displays "Over Limit" and sounds an Error Tone. Then it returns to Channel selection.

Select the Channel Name and press [E / yes / gps] to go to the Channel Settings Menu.

Select "Paste Channel" and press [E / yes / gps] to paste the Channel. All settings are copied, then the scanner goes to the Channel Settings Menu.

If the "New Channel" is selected by pressing [E / yes / gps], you need to enter the frequency for a conventional System's Channel or the TGID for a trunked system Channel.

Input Frequency:

You must enter a frequency.

Note: Please see: Band Coverage for acceptable frequencies.

Press [E / yes / gps] to set the frequency. The channel name is set to the frequency as a default name as "xxxx.xxxxMHz". Then the scanner goes to the Channel Settings Menu.

Press [Menu] to return to the previous selection and cancel adding a Channel.

Input TGID:

You must enter a TGID.

You can input only a TGID in the format suitable for the site type.

Motorola Type ID (Decimal Format ID) :

When the custom Fleet Map setting for a MOT system is not all Size Code 0 for Blocks, the scanner treats the System as a Motorola Type I.

Press the number keys to enter the Block number, Fleet number and SubFleet number.

Press the decimal key to enter a hyphen.

Note: 1 digit Block number, 2 - 3 digits Fleet number, hyphen and 1 - 2 digits SubFleet number.

When the set Preset Fleet Map or custom Fleet Map has all Blocks with Size Code 0, the scanner treats the System as a Motorola Type II.

Press the number keys to enter the TGID.

Note: Numbers only (up to 5 digits)

Motorola Type ID (Hex Format ID) :

Turn [Scroll Control] to select Hex character from "0" to "F".

Press [4 / LEFT / ifx] or [6 / RIGHT / disp] to move cursor left or right.

Press [E / yes / gps] to set the Hex ID.

Note: When the custom Fleet Map setting set to Size Code 0 for all Blocks, the scanner treats the System as a Motorola Type I or Hybrid system. In these cases Hexadecimal input will be treated as same as Decimal ID. (see *FLEET MAP* for detail)

E.g. If you enter "1", "2" as a Type I Hex ID, it will be treat as 12, not 0x12.

P25 Type ID (Decimal Format ID) :

For P25 Standard Trunk sites or One-freq Trunk systems.

Press the number keys to enter the TGID.

Note: Numbers only(up to 8 digits)

P25 Type ID (Hex Format ID) :

Turn [Scroll Control] to select Hex character from "0" to "F".

Press [4 / LEFT / ifx] or [6 / RIGHT / disp] to move cursor left or right.

Press [E / yes / gps] to set the Hex ID.

EDACS ID :

For EDCS Wide/Narrow systems.

Press the number keys to enter the Agency number.

Press the decimal key to enter a hyphen.

Press the number keys to enter the Fleet number and SubFleet number.

Note: Agency number (00 - 15), hyphen, Fleet number (00 - 15) and SubFleet number (0 - 7)

The scanner does not accept all zero ID ("00-000").

You can omit the SubFleet number as a wildcard.

You can omit Fleet numbers and SubFleet numbers as wildcards.

LTR ID :

For LTR systems.

Press the number keys to enter the Area code, Home repeater and User ID.

Note: 6 digit numbers; Area code (0 or 1), Home repeater (01 - 20), User ID (000 - 254)

I-Call (Motorola, EDACS, P25) :

For any MOT System, EDCS Wide and Narrow, P25 Standard Trunk or P25 One-Freq Trunk system.

First, press the decimal key to enter "i" for I-Call. Then press the number keys to enter the ID.

Note: For details of TGID format, please see: *TGID FORMAT FOR TRUNKED SYSTEM*.

Press [E / yes / gps] to set the TGID. The Channel Name is set to the TGID as default name as "ID:xxxx".

Then the scanner goes to the Channel Settings Menu.

Press [Menu] to return to the previous selection and cancel adding a Channel.

Channel Settings

The following settings are available for channels.

- Edit Name
- Edit Frequency
- Edit TGID
- Set Audio Type
- Set Number Tag
- Set Modulation
- Set Attenuator
- Set Priority
- Set Alert
- Set Lockout
- Volume Offset
- Copy Channel
- Delete Channel
- New Channel

The specific settings available depend on the current system type.

See *Channel Settings* for details of the differences.

Note: The first Line in the display shows the name of the Channel in Menu Display.

Edit Name

You can provide a name for the channel.

Refer to FONT DATA for the characters that can be entered.

Press [E / yes / gps] to accept the name entered. The scanner returns to the previous menu.

Edit Frequency

If you select to edit the frequency, the scanner displays the current frequency in edit mode.

See *Edit Frequency*.

Edit TGID

If you select to edit the TGID, the scanner displays the current ID. You can use the keypad to change the ID.

When you press [E / yes / gps] to accept, the scanner checks for valid data and returns to the previous menu.

If the ID is invalid, the scanner shows “Bad TGID” and “Press Any Key” and sounds an error tone. Press any key to return to the editing state.

Set Audio Type

You can select an audio type for each channel.

All	The scanner receives both Digital and Analog signals.
Digital Only	The scanner receives only Digital signals.
Analog Only	The scanner receives only Analog signals.

If you select “All”, the scanner returns to previous menu.

If you select “Digital Only” while setting a conventional system, you can set the P25 NAC (Network Access Code) option from the following items. However, these options are not shown for trunked systems.

Search	The scanner searches for all the P25 NACs.
Set P25 NAC	The scanner search for the programmed P25 NAC.

If you select “Search”:

The scanner returns to the previous menu.

If you select “Set P25 NAC”:

Use the number keys to enter a P25 NAC. The valid range is from 0 to FFF.

Press [E / yes / gps] to set and return to the previous menu.

If you select “Analog Only” while setting a conventional system, you can set the CTCSS/DCS options from the following items. However, these options do not display when setting for trunked system.

Off	The scanner ignores all tones and opens squelch on any signal.
Search	The scanner displays any tone being used, but opens squelch on any signal.
CTCSS	The scanner prompts you for the appropriate setting. Squelch will open for this Channel only if the code matches.
DCS	The scanner prompts you for the appropriate setting. Squelch will open for this Channel only if the code matches.
Set Lockout	The scanner prompts you to select CTCSS/DCS settings to ignore. Squelch will not open for this Channel only if the code matches.

*For AM or WFM modulation, this setting will be ignored.

The scanner does not detect or decode P25 signals if you are operating CTCSS/DCS Search.

If you select “Off” or “Search”:

The scanner returns to the previous menu.

If you select “CTCSS” or “DCS”:

You can select the CTCSS frequency or DCS code. (Refer to CTCSS FREQUENCY and DCS CODE for selectable frequencies and codes.)

Turn [Scroll Control] to select.

Press [E / yes / gps] to set and return to the previous menu.

If you select “Set Lockout”:

You can select a CTCSS or DCS for lockout.

Turn [Scroll Control] to select and press [E / yes / gps] key to lock it out. Then the scanner returns to the previous menu.

Set Number Tag

The Channel Number Tag can be set in this menu.

Press a number key to input the number tag. Press [. / no / pri] to clear the input.

Press [E / yes / gps] to accept the setting and return to the previous menu.

Note: The valid setting range is from 0 to 999. Blank means a number tag not assigned.

Set Modulation

You can select the modulation from the following settings.

Auto	The scanner uses the modulation normal for the frequency's band. (See: <u>Band Defaults</u>)
AM	The scanner uses AM demodulation.
NFM	The scanner uses Narrowband FM demodulation.
FM	The scanner uses FM demodulation.
WFM	The scanner uses Wideband FM demodulation.
FMB	The scanner uses FM Broadcast demodulation.

Press [E / yes / gps] to accept the entry and return to the previous menu.

Set Attenuator

You can attenuate RF reception on the frequency.

- On The frequency will be attenuated.
- Off The frequency will not be attenuated.

Press [E / yes / gps] to accept the selection and return to the previous menu.

Set Priority

This option sets the Channel as a Priority Channel. You can set this On for each Channel independently. See [PRIORITY SCAN](#) to see how this works for conventional. See [PRIORITY ID SCAN](#) to see how this works for trunking.

- On The Channel is treated with priority.
- Off The Channel is not treated with priority.

Press [E / yes / gps] to accept the entry and return to the previous menu.

Note: Although any conventional frequency can be set as a priority channel, the scanner is unable to scan over the number of priority channels that was set at menu [MaxCHs/Pri-Scan](#). If unlocked priority channels are over this setting, only that portion of the priority channels will be scanned for priority.

Set Alert

Channel alert options can be set using this menu.

Set Alert Tone
Set Alert Light

Press [E / yes / gps] to enter the setting.

Set Alert Tone

You can select whether the scanner should sound an Alert Tone when this Channel becomes active*.

Off No alert sounds.
Alert 1-9 The scanner sounds Alert1-9 with the Channel becomes active.

If you select "Off", the scanner returns to the previous menu.

If you select "Alert1-9", the scanner goes to Alert Level selection.

Auto The alert is set to the same volume as normal audio.
Level1-15 The alert is fixed to the selected audio level.

Press [E / yes / gps] to accept the entry and return to the previous menu.

Set Alert Light

You can select whether the scanner should have an alert light when this Channel becomes active*.

Off
Blue
Red
Magenta
Green
Cyan
Yellow
White

If you select "Off", the scanner returns to the previous menu.

If you select an alert light color, the scanner goes to the Alert Light Pattern selection.

On The alert light is set to on
Slow Blink The alert light blinks slowly
Fast Blink The alert light blinks fast

Press [E / yes / gps] to accept the entry and return to the previous menu.

*"Active" means that the scanner received a signal on the Channel in Scan Mode or Scan Hold Mode, or the Channel is selected in Scan Hold Mode.

Set Lockout

This option allows you to lock or unlock the current channel. When the channel is locked out, the scanner does not check it.

Unlocked	The channel is unlocked.
Temporary L/O	The channel is temporarily locked out.
Lockout	The channel is locked out.

Press [E / yes / gps] to accept the selection and return to the previous menu.

Volume Offset

This option is used to set a volume offset for each channel. The feature can let you adjust the volume level relative to other channels when the frequency is active. Setting level are:

- 3
- 2
- 1
- 0
- +1
- +2
- +3

Press [E / yes / gps] to accept the selection and return to the previous menu.

Copy Channel

You can copy a Channel and all associated settings by selecting this menu item.

The Channel Information is copied to the Copy Buffer when this item is selected. The Copy Buffer just has the last copied Channel Information.

The scanner displays "Copy Channel" and "Copied to Buffer" when you press [E / yes / gps].

Note: Pasting a Channel will not clear this Copy Buffer (See: Edit Channel)

Delete Channel

You can delete the current channel and all associated settings by select this menu item. The scanner prompts "Confirm Delete?" to confirm deletion.

Press [E / yes / gps] to delete the current channel.

Press [. / no / pri] to cancel deletion and return to the previous menu.

New Channel

Press [E / yes / gps] to create a New Site and go to *Channel Settings*.

Program Location

You can select the any Location for programming or create a new Location.

First, select the location type to edit or create from the following types:

- POI
- Dangerous Xing
- Dangerous Road

Select an existing location or New Location. For a POI, it goes to *POI Settings*. For a “Dangerous Xing” or “Dangerous Road”, it goes to *Dangerous Xing / Road Settings*.

Note: You can review all created Locations in Review Location Mode. (See *Review Location Mode*.)

POI Settings

You can set the following items.

- Edit Name
- Set Type
- Set Alert
- Set LocationInfo
- Set Range
- Set Lockout
- Delete Location
- New Location

Turn [Scroll Control] and press [E / yes / gps] to go to each setting.

Dangerous Xing / Road Settings

You can set the following items.

- Edit Name
- Set Type
- Set Alert Volume
- Set Alert Light
- Set LocationInfo
- Set Heading
- Set Speed Limit
- Set Lockout
- Delete Location
- New Location

Turn [Scroll Control] and press [E / yes / gps] to go to each setting.

Edit Name

You can name the location.

Refer to FONT DATA for the characters that can be entered.

Press [E / yes / gps] to *accept* the name entered. The scanner returns to the previous menu.

Set Type

This option can be used to select the location type.

- POI
- Dangerous Xing
- Dangerous Road

Turn [Scroll Control] to select the type and press [E / yes / gps] to accept it.

Then the scanner returns to the previous menu.

Set Alert

Set Alert Tone

You can select whether the scanner should sound an Alert Tone when approaching the set Location.

- | | |
|-------------|---|
| Off | No alert sounds. |
| Alert 1 - 4 | The scanner sounds Alert1 - 4 when you approach the Location. |

If you select "Off", the scanner returns to the previous menu.

If you select "Alert1 - 4", the scanner goes to the Alert Level selection.

- | | |
|-------------|--|
| Auto | The alert is set to the same volume as normal audio. |
| Level1 - 15 | The alert is fixed to the selected audio level. |

Set Alert Light

You can select whether the scanner should have an Alert Light when you approach the set Location.

- Off
- Blue
- Red
- Magenta
- Green
- Cyan
- Yellow
- White

If you select "Off", the scanner returns to the previous menu.

If you select an alert light color, the scanner goes to the Alert Light Pattern selection.

- | | |
|------------|-------------------------------|
| On | The alert light is set to on |
| Slow Blink | The alert light blinks slowly |
| Fast Blink | The alert light blinks fast |

Press [E / yes / gps] to accept the entry and return to the previous menu.

Note: This setting menu appears only in "POI".

Set Alert Volume

This option can be used to set the alert level.

Auto	The alert is set to the same volume as normal audio.
Level1-15	The alert is fixed to the selected audio level.
Off	No alert sounds.

Press [E / yes / gps] to accept the data and return to the previous menu.

Note: This setting menu appears in “Dangerous Xing” and “Dangerous Road”.

Set Alert Light

This option can be used to set Alert Light.

- Off
- Blue
- Red
- Magenta
- Green
- Cyan
- Yellow
- White

If you select “Off”, the scanner returns to the previous menu.

If you select an alert light color, the scanner goes to the Alert Light Pattern selection.

On	The alert light is set to on
Slow Blink	The alert light blinks slowly
Fast Blink	The alert light blinks fast

Press [E / yes / gps] to accept the entry and return to the previous menu.

Note: This setting menu appears in “Dangerous Xing” and “Dangerous Road”.

Set LocationInfo

You use this option to set the location data.

First, you set the latitude.

Press the number keys to enter latitude data. Press any number key when the cursor is in the last position to toggle between south latitude (S) and the north latitude (N).

Press [E / yes / gps] to go to the longitude setting.

Press the number keys to enter longitude settings. Press any number key when the cursor is in the last position to toggle between east longitude (E) and west longitude (W).

Press [. / no / pri] to jump to the next input area. For example, press [. / no / pri] on Degree Number for DMS to jump to the Minute Number. Press this again to jump to the second number. Press [. / no / pri] or a number key on N/S or W/E to toggle these settings.

Set Range

This option sets the range for a POI.

In this menu, the setting unit depends on the setting in Set Unit.

When you select “mile” in Set Unit the displayed unit will be miles.

When you select “km” in Set Unit the displayed unit will be kms.

The valid setting range is from 0.05 to 4.0, by 0.05 steps.

Press [E / yes / gps] to accept the setting and return to the previous menu.

Note: This setting menu appears only in “POI”.

Set Heading

This option sets the heading direction-based alerts.

The options are:

All Range	The scanner always sounds an alert and turns on the Alert Light when you go into range of the location.
North (0°)	South (180°)
NE (45°)	SW (225°)
East (90°)	West (270°)
SE (135°)	NW (315°)

Press [E / yes / gps] to accept the and return to the previous menu.

Note: This setting menu appears in “Dangerous Xing” and “Dangerous Road”.

Set Speed Limit

This option sets the speed limit for location alerts. The scanner only alerts when your speed is over this setting.

In this menu, the setting unit depends on the setting in Set Unit.

When you select “mile” in Set Unit the displayed unit will be “mph”.

When you select “km” in Set Unit the displayed unit will be “km/h”.

The valid setting range is from 0 to 200, in steps of 1.

Press [E / yes / gps] to accept the entry and return to the previous menu.

Note: This setting menu appears in “Dangerous Xing” and “Dangerous Road”.

Set Lockout

This option allows you to lock or unlock the current location. When the location is locked out, the scanner does not check it.

Unlocked	The location is unlocked.
Temporary L/O	The location is temporarily locked out.
Lockout	The location is locked out.

Press [E / yes / gps] to accept the selection and return to the previous menu.

Delete Location

You can delete the current location and all associated settings by select this menu item. The scanner prompts "Confirm Delete?" to confirm deletion.

Press [E / yes / gps] to delete the current location.

Press [. / no / pri] to cancel deletion and return to the previous menu.

New Location

If you select this in the "POI" setting menu and press [E / yes / gps], the scanner creates a New POI and goes to POI Settings.

Or, if you select this item in "Dangerous Xing" or "Dangerous Road", the scanner creates a New Dangerous location and goes to Dangerous Xing / Road Settings.

Srch/CloCall Opt

This menu includes the following:

- Freq Lockouts
- Broadcast Screen
- Tone/Code Search
- Repeater Find
- Max Auto Store
- Set Delay Time
- Set Attenuator
- Set Audio AGC
- P25 Waiting Time

Press [E / yes / gps] to go to each setting.

Each setting in these options is applied to some or all Search Modes*.

*"Search Mode" is Service Search, Custom Search, Quick Search, Search and Store, Close Call and CC Auto Store.

The mode in which a setting is applied showed in the following table.

	Service Search*1	Custom Search*1	Quick Search	Search and Store	Close Call	CC Auto Store	CC Hits System	Band Scope
Freq Lockouts	0	0	0	0	0	0		
Broadcast Screen		0	0	0 ^{*2}	0	0		
Tone/Code Search	0	0	0	0	0	0		
Repeater Find		0	0		0			
Max Auto Store				0		0		
Set Delay Time			0		0		0	
Set Attenuator			0		0	0		0
Set Audio AGC			0		0		0	
P25 Waiting Time			0		0		0	0

*1While searching a search range in Search with Scan, these settings are valid.

*2In Search and Store, this setting is valid only when the scanner stores a Custom Search frequency.

Freq Lockouts

You can select from these items.

Unlock All
Rvw Search L/O

Press [E / yes / gps] to enter each menu.

Unlock All

Selecting this causes the scanner to prompt "Confirm?" and "Unlock All(Y/N)".

Press [E / yes / gps] to unlock all frequencies. Then the scanner returns to *Freq Lockouts*.

Press [. / no / pri] to cancel this and return to the previous menu.

Note: If no frequencies have been locked, the scanner displays "Nothing Locked".

Press any key to return to the previous menu.

Rvw Search L/O

Allows you to review frequencies that are locked out in Search Mode or Close Call Mode. Any frequency in this list will be skipped if encountered in these modes.

The first Line displays "Unlock?(Y/N)" and the remaining lines display locked out frequencies.

Turn [Scroll Control] to choose frequencies.

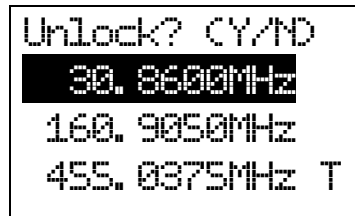

```
Unlock? (Y/N)
30.8600MHz
160.9050MHz
455.0375MHz T
```

"T" will be displayed following the frequency if it is a temporary lockout frequency.

Press [E / yes / gps] to unlock the displayed frequency and change to the next locked out frequency.

Press [. / no / pri] to advance to the next locked out frequency.

Press [Menu] to return the previous menu.

Note: If no frequencies have been locked, the scanner displays "Nothing Locked".

If you unlock the last frequency, the scanner displays "Nothing Locked".

Broadcast Screen

This option sets whether the scanner screens broadcast frequencies.

You can select the following items.

- Set All Band On
- Set All Band Off
- Set Each Band
- Program Band

Press [E / yes / gps] to enter each menu.

Set All Band On

This function can turn all bands On.

When you press [E / yes / gps], the scanner displays “All Band” and “On”.

The scanner then returns to the previous menu.

Set All Band Off

This function can turn all bands Off.

When you press [E / yes / gps], the scanner displays “All Band” and “Off”.

The scanner then returns to the previous menu.

Set Each Band

You can turn on or off each of the following bands.

Pager	:	On/Off	:	Various, according to FCC allocation
FM	:	On/Off	:	88.1000 - 107.9000 MHz
UHF TV	:	On/Off	:	470.0000 - 512.0000 MHz
VHF TV	:	On/Off	:	54.0000 - 72.0000 MHz
			:	76.0000 - 88.0000 MHz
			:	174.0000 - 216.0000 MHz
NOAA WX	:	On/Off	:	161.6500, 161.7750, 162.4000, 162.4250, 162.4500, 162.4750, 162.5000, 162.5250, 162.5500, 163.2750 MHz
Band 1	:	On/Off		
Band 2	:	On/Off		
:				
Band 10	:	On/Off		

On The scanner ignores hits on the band frequencies.

Off The scanner does not Screen for the band frequencies.

Turn [Scroll Control] to put the cursor focus on the band that you want to change, and press [E / yes / gps] to change the setting.

Then press [Menu] to return to the previous menu.

Program Band

You can set up to 10 custom band screens. Select a band and press [E / yes / gps] to go to the limit setting.

You need to set a lower and upper limit frequency. First, enter the lower limit frequency and store it by pressing [E / yes / gps]. Next, enter the upper limit frequency and press [E / yes / gps] to store the upper limit. The scanner returns to the previous menu.

Note: If the lower frequency is larger than the upper frequency, the setting is automatically changed.

Tone/Code Search

This option sets whether the scanner will search for a CTCSS/DCS code or P25 NAC code when it finds an active frequency.

Off The scanner does not search for CTCSS/DCS codes.
CTCSS/DCS Search The scanner searches for CTCSS/DCS codes.

If the scanner detects the code, it displays the found code.

P25 NAC Search The scanner searches for P25 NAC codes.

If the scanner detects a NAC code, it displays NAC code.

Press [E / yes / gps] to set this setting and return to the previous menu.

Note: For AM, WFM or FMB modulation, this setting is ignored and the scanner treats this setting as "Off".

If you set this function to "CTCSS/DCS Search", the scanner will not decode APCO P25 signals.

Repeater Find

This option sets whether the scanner attempts to locate the transmission on a repeater output frequency when it detects a transmission on a common repeater input frequency.

On The scanner automatically applies repeater reverse to detected transmissions. If the scanner can detect the transmission on the output frequency, it displays "Repeater Found" on the display, and remains on the output frequency. If it does not detect the transmission on the output frequency or it lost the found signal, the scanner remains on the transmission on the original frequency.
Off The scanner does not perform Repeater Find.

Press [E / yes / gps] to set this setting and return to the previous menu.

Note: You cannot lock out the Repeater frequency. And Repeater frequencies are not related to the locked out frequency list of *Freq Lockouts*.

Max Auto Store

This setting controls how many hits the scanner will automatically store in either Search and Store or Close Call Auto Store.

When the scanner has saved the maximum number of hits set by this setting, it stops storing.

When there are already more auto-stored Channels than the number of Max Auto Store, the scanner will not perform Auto Store operation.

The valid setting range is from 1 to 256.

Press the number keys to enter the number.

Press [E / yes / gps] to set this setting. Then return to previous menu.

If you enter 0, the scanner prompts "Out of Range" and "Set Min? (Y/N)". Press [E / yes / gps] to set the value to minimum "1". Or, press [. / no / pri] to return to editing state and the entered value is set to "1".

If you enters over 256, the scanner prompts "Out of Range" and "Set Max? (Y/N)". Press [E / yes / gps] to set the value to maximum "256". Or, press [. / no / pri] to return to editing state and the entered value is set to "256".

Set Delay Time

This setting controls how long the scanner stays on frequency after a transmission ends before resuming searching.

Turn [Scroll Control] to select the delay time setting from the following list:

- 10 sec
- 5 sec
- 2 sec
- 0 sec
- 1 sec
- 2 sec
- 5 sec
- 10 sec
- 30 sec

Then press [E / yes / gps] to accept and return to the previous menu.

Set Attenuator

You can select to attenuate RF reception on all frequencies in the search range.

- On The frequencies are attenuated.
- Off The frequencies are not attenuated.

Press [E / yes / gps] to accept the entry and return to the previous menu.

Set Audio AGC

When Audio AGC function is “On”, the scanner judges the volume level and changes the volume automatically.

You can turn either Analog or Digital audio “On” or “Off”.

Analog :	On / Off
Digital :	On / Off
On	Audio AGC is on.
Off	Audio AGC is off.

Turn [Scroll Control] to focus the cursor on the item. Press [E / yes / gps] to change the setting on / off and press [Menu] to return to the previous menu.

P25 Waiting Time

The feature is used to set a wait time for P25 decode. After receiving a transmission the scanner will wait for the set duration to check if there is any P25 signal.

Selectable waiting times are:

- 0 ms
- 100 ms
- 200 ms
- 300 ms
- 400 ms
- 500 ms
- 600 ms
- 700 ms
- 800 ms
- 900 ms
- 1000 ms

Press [E / yes / gps] to accept the selection and return to the previous menu.

Search for...

This menu includes the following items.

- Service Search
- Edit Service
- Custom Search
- Edit Custom
- Search and Store
- Set Search Key

Press [E / yes / gps] to enter each item.

Service Search

You can select from 12 preset search bands for searching.

- Public Safety
- News
- Ham Radio
- Marine
- Railroad
- Air
- CB Radio
- FRS/GMRS/MURS
- Racing
- FM Broadcast
- Military Air
- Special

Press [E / yes / gps] to exit from Menu Mode and start searching the selected band.

(See: *Service Search*)

Edit Service

Select Service Search Range and press [E / yes / gps] to go to each Search Range Setting.

You can set the following items for each Service Search Range.

- Set Delay Time
- Set Attenuator
- Set Audio AGC
- P25 Waiting Time
- Search with Scan

Press [E / yes / gps] to enter each setting.

Note: The first line in the display shows the name of the selected Service Search.

Set Delay Time

This setting controls how long the scanner stays on frequencies after a transmission ends before resuming searching.

Turn [Scroll Control] to select the delay time setting from the following list:

- 10 sec
- 5 sec
- 2 sec
- 0 sec
- 1 sec
- 2 sec
- 5 sec
- 10 sec
- 30 sec

Then press [E / yes / gps] to accept and return to the previous menu.

Set Attenuator

You can select to attenuate RF reception on all frequencies in the search range.

- On The frequencies are attenuated.
- Off The frequencies are not attenuated.

Press [E / yes / gps] to accept the entry and return to the previous menu.

Set Audio AGC

When Audio AGC function is "On", the scanner judges the volume level and changes the volume automatically.

You can turn either Analog or Digital audio "On" or "Off".

Analog :	On / Off
Digital :	On / Off

- On Audio AGC is on.
- Off Audio AGC is off.

Turn [Scroll Control] to focus the cursor on the item. Press [E / yes / gps] to change the setting on / off and press [Menu] to return to the previous menu.

P25 Waiting Time

The feature is used to set a wait time for P25 decode. After receiving a transmission the scanner will wait for the set duration to check if there is any P25 signal.

Selectable waiting times are:

- 0 ms
- 100 ms
- 200 ms
- 300 ms
- 400 ms
- 500 ms
- 600 ms
- 700 ms
- 800 ms
- 900 ms
- 1000 ms

Press [E / yes / gps] to accept the selection and return to the previous menu.

Search with Scan

You can set the following items.

- Set Quick Key
- Set Startup Key
- Set Number Tag
- Set Lockout
- Set Hold Time

Press [E / yes / gps] to enter each setting.

Set Quick Key

You can select a Quick Key from 0 to 99 or “.” (= Not assigned) by turning [Scroll Control].

Quick Key for search is used to rapidly enable or disable the range. The searching order does not change by this setting.

Press [E / yes / gps] to accept and return to the previous menu.

Set Startup Key

The scanner locks or unlocks the search according to setting of this option by pressing and holding a number key at power-on or while displaying the Opening Screen.

Turn [Scroll Control] to select the Startup Key in this menu. The Startup Key can be set from “0” to “9” and “.” (= Not assigned).

Press [E / yes / gps] to accept the selection and return to the previous menu.

Set Number Tag

A Number Tag can be set in this menu.

Press a number key to input the number tag. Press [./ no / pri] to clear the input.

Press [E / yes / gps] to accept the setting and return to the previous menu.

Note: The valid setting range is from 0 to 999. Blank means a number tag not assigned.

Set Lockout

This option allows you to lock or unlock the current search. When the search is locked out, the scanner does not check it.

Unlocked	The search is unlocked.
Temporary L/O	The search is temporarily locked out.
Lockout	The search is locked out.

Press [E / yes / gps] to accept the selection and return to the previous menu.

Set Hold Time

This setting determines the maximum time the scanner is forced to hold and search this range before moving to the next, even if there is no traffic on the frequencies.

You can change the hold time from 0 (the scanner checks all frequencies of the range regardless of time) to 255 seconds by using number keys.

If the setting is something other than "0", the scanner goes to the next system or search when the hold time elapses. However, it does not go to next one while receiving a signal.

Press [E / yes / gps] to accept the entry and return to the previous menu.

If you enter over "255" for the Hold Time, the scanner prompts "Out of Range" and "Set Max? (Y/N)". When [E / yes / gps] is pushed, maximum value 255 will be set.

It returns to the edit state, if you press [. / no / pri].

Custom Search

The scanner exits from Menu Mode and goes to Search Mode. Then it starts searching the Custom Ranges. (See: Custom Search)

Edit Custom

You can edit the 10 Custom Search Ranges.

Names of Custom Search Ranges are displayed as Menu items.

For example, if all names are not changed from default name, selectable items are as follows:

Custom 1
Custom 2
:
Custom 10

Select the Name and press [E / yes / gps] to go to Menu of editing Custom settings.

Custom Settings

You can edit the follow settings.

Edit Name
Edit Srch Limit
Set Delay Time
Set Modulation
Set Attenuator
Set Step
Set C-Ch Only
Set Audio AGC
P25 Waiting Time
Search with Scan

Press [E / yes / gps] to enter each item.

Note: The first line displays the name of the selected Custom Search.

Edit Name

You can name the custom range.

Refer to *FONT DATA* for the characters that *can* be *entered*.

Press [E / yes / gps] to accept the name entered. The scanner returns to the previous menu.

Edit Srch Limit

You need to set 2 limits for searching.

First, enter the lower limit frequency and store it by pressing [E / yes / gps].

Next, enter the upper limit frequency and press [E / yes / gps] to store the upper limit

The scanner returns to the previous menu.

Note: If the entered Lower Limit is higher than the entered Upper Limit, the scanner will swap these automatically.

Set Delay Time

This setting controls how long the scanner stays on frequencies after a transmission ends before resuming searching.

Turn [Scroll Control] to select the delay time setting from the following list:

- 10 sec
- 5 sec
- 2 sec
- 0 sec
- 1 sec
- 2 sec
- 5 sec
- 10 sec
- 30 sec

Then press [E / yes / gps] to accept and return to the previous menu.

Set Modulation

You can select the modulation from the following settings.

- Auto The scanner uses the modulation normal for the frequency's band. (See: [Band Defaults](#))
- AM The scanner uses AM demodulation.
- NFM The scanner uses Narrowband FM demodulation.
- FM The scanner uses FM demodulation.
- WFM The scanner uses Wideband FM demodulation.
- FMB The scanner uses FM Broadcast demodulation.

Press [E / yes / gps] to accept the entry and return to the previous menu.

Set Attenuator

You can select to attenuate RF reception on all frequencies in the search range.

- On The frequencies are attenuated.
- Off The frequencies are not attenuated.

Press [E / yes / gps] to accept the entry and return to the previous menu.

Set Step

You can select the search step for Custom Search.

- | | |
|----------|---|
| Auto | Automatically assign the search step based on the band. |
| 5.0 kHz | 15.0 kHz |
| 6.25kHz | 20.0 kHz |
| 7.5 kHz | 25.0 kHz |
| 8.33kHz | 50.0 kHz |
| 10.0 kHz | 100.0 kHz |
| 12.5 kHz | |

Press [E / yes / gps] to accept the setting and return to the previous menu.

Set C-Ch Only

These options let you set whether the scanner tracks talk group activity when it detects a Motorola or LTR control channel. This section has the following menus:

- C-Ch Only Mode
- Set MOT BandPlan

C-Ch Only Mode

You can select how the scanner tracks Motorola System and LTR System. (C-Ch means Control Channel.)

- On The scanner only searches for Motorola and LTR Control Channels.
- Off The scanner treats all signals as normal transmission.

Press [E / yes / gps] to accept the entry and return to the previous menu.

Set MOT BandPlan

You can select one of the following options to assign a band plan that the scanner will use if it detects a Motorola control channel. Note that if the actual received channel does not use the specified band plan, the scanner will not follow voice traffic on the system.

The instructions for doing this are the same as for setting a band plan for a programmed system. See [Edit Band Plan \(Mot\)](#) for option settings.

Set Audio AGC

When Audio AGC function is "On", the scanner judges the volume level and changes the volume automatically.

You can turn either Analog or Digital audio "On" or "Off".

- | | |
|-----------|-------------------|
| Analog : | On / Off |
| Digital : | On / Off |
| On | Audio AGC is on. |
| Off | Audio AGC is off. |

Turn [Scroll Control] to focus the cursor on the item. Press [E / yes / gps] to change the setting on / off and press [Menu] to return to the previous menu.

P25 Waiting Time

The feature is used to set a wait time for P25 decode. After receive a transmission the scanner will wait for the set duration to check if there is any P25 signal.

Selectable waiting times are:

- 0 ms
- 100 ms
- 200 ms
- 300 ms
- 400 ms
- 500 ms
- 600 ms
- 700 ms
- 800 ms
- 900 ms
- 1000 ms

Press [E / yes / gps] to accept the selection and return to the previous menu.

Search with Scan

This menu is same as the one in the Edit Service Menu.

See *Search with Scan*.

Search and Store

This function lets the scanner search for new frequencies in Custom Search Ranges or Service Search Ranges, or new TGID's on a trunked System.

First, select a System to store the found Channels into. The scanner displays all created Systems. Turn [Scroll Control] to select the System. Press [E / yes / gps] to make the selection.

If there are no Systems, you cannot perform this function. The scanner sounds an Error Tone and displays "No System Stored". Press any key to return to the previous menu.

Note: In this function, the scanner ignores the setting of Repeater Find.

For Conventional System

If a conventional System is selected, the scanner prompts you for "Custom Search" and Service Search ranges. Turn [Scroll Control] to select the kind of search to use.

- Custom Search
- Public Safety
- News
- Ham Radio
- Marine
- Railroad
- Air
- CB Radio
- FRS/GMRS/MURS
- Racing
- FM Broadcast
- Military Air
- Other

Once a search range is selected by pressing [E / yes / gps], any time a frequency in that search range goes active, the scanner checks to see if that frequency has been previously stored in that System. If so, it resumes searching. Otherwise, it stores the frequency into the Group named "Found Channels" (the scanner automatically creates this group if it does not exist). Then it resumes searching.

Note: If all frequencies of the selected search are locked out, the scanner displays "All Locked!" on Second line and it cannot start storing operation. Then it goes to End State. (See: End Conditions)

During Search and Store for a conventional System, "SEARCH AND STORE" scrolls on the second line.

"System Name" and "Search Range Name" are alternately displayed on first line.

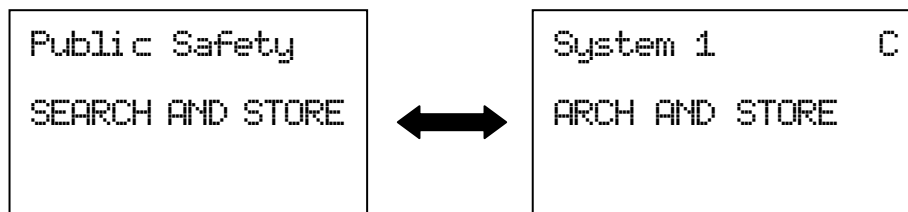

If the scanner finds a frequency, it performs duplication check in the System and displays "Memory Check" on second line. And while storing the frequency to Memory, it displays "Storing" on second line.

For Trunked System

If a trunked System is selected, you will be asked to select a site. If no site is stored in that system, message "No Site Stored Press Any Key" will be displayed and the scanner will sound an error tone. After the site is selected, the scanner begins searching that System. Any time a TalkGroup goes active, the scanner checks to see if that TalkGroup has been previously stored in that System. If so, it resumes searching. Otherwise, it stores the TGID into the Group named "Found Channels" (the scanner automatically creates this Group if it does not exist). Then it resumes searching.

If the selected site is locked out, it is unlocked and the scanner starts ID Auto Store on the site.

Note: Search and Store does not work in the following conditions. The scanner sounds an Error Tone, and it displays System Name on first Line and *Error Message* on second line. Then it goes to End State. (See: End Conditions)

Error Condition	Error Message
A System / a Site that has no frequency is selected.	"No Control Chan"
The Quick Key for the System / Site to which that System / Site belongs is turned off.	"Nothing to Scan"
The Group that stores found Channels already has the number of Max Auto Store or more Channels stored.	"Over Limit"

Note: The following selections are invalid. The scanner displays *Error Message* and "Press Any Key". Press any key to return to System selection.

Error Condition	Error Message
EDACS SCAT System is selected.	"Invalid System"
A system that does not store a site that can be selected.	"No Site Stored"

During Search and Store operation for a trunked System, "ID SEARCH AND STORE" scrolls on the second line. System / Site Name is displayed on the first Line.

```
Site 3-1      MOT
ID SEARCH AND ST
  NFM      \ /
SQ: - - - 4 - - - - -
GRP- - - / \ - - - - -
```

If the scanner finds a TGID, it performs a duplication check in the System (the scanner does not show this state). And while storing the TGID into Memory, it displays "Storing" on the second line.

End Conditions

The scanner will stop storing if the number of found frequencies or TGID exceeds Max Auto Store. Then it displays "Limit Reached" and sounds a Confirmation Tone.

When the number of Channels in trunked System exceeds 500, the scanner stops the storing operation. Then it displays "TGID Full".

When it exceeds the limit of Group/Channel creation during a storing operation, the scanner stops the storing operation. Then it displays "Over Limit" and sounds an Error Tone.

If the Memory is full, it displays "Memory Full" on the second line and sounds an Error Tone.

It does not exit from Search and Store Mode automatically.

During "Search and Store" operation or in one of the above-mentioned End State, only the following operations are valid.

Pressing [Hold / 

Pressing [Scan / srch] exits this mode and goes to Scan Mode.

Pressing [Menu] exits this mode and the scanner goes to the Menu Mode. If you exit from Menu Mode, the scanner goes to each Search Mode (selected Search for storing operation).

Pressing [FUNC] + [Menu] also exits from this mode and goes to each Menu.

Note: In this mode, you cannot hear any transmission.

Set Search Key

The scanner has three search keys that let you quickly start a search range: "Search Key 1", "Search Key 2", and "Search Key 3".

Select the number of Search Key and set a search range from the Service Search ranges, Custom Search ranges, Tone-Out and Band Scope.

Press [E / yes / gps] to accept the entry and return to the previous menu.

Close Call

This menu has the following items.

- Close Call Only
- CC Auto Store
- Hits with Scan
- Set CC Mode
- Set CC Override
- Set CC Alert
- Set CC Bands

Note: "CC" means "Close Call".

Press [E / yes / gps] to enter the menu.

Close Call Only

When this item is selected at Close Call, the scanner exits from the Menu Mode and goes to the Close Call Only Mode. Then it starts searching for Close Call hits. (See: Close Call Only)

CC Auto Store

When this item is selected at Close Call, the scanner exits from the Menu Mode and goes to the CC Auto Store Mode. Then the scanner automatically stores new CC hits (up to the limit set by the Max Auto Store setting) into the Group named "Found Channels" of System named "Close Call" (automatically created if it does not exist).(See: Close Call Auto Store)

Note: In this mode, you cannot hear any Close Call transmission.

Hits with Scan

These are the settings for the Close Call temporary stored system.

The setting items are as follows.

- Set Quick Key
- Set Number Tag
- Set Lockout
- Set Hold Time

Press [E / yes / gps] to enter the menu.

Set Quick Key

You can select a Quick Key from 0 to 99 or "." (= Not assigned) by turning [Scroll Control]. The Quick Key is only for rapidly enabling or disabling the system and is not for deciding the scan priority.

Press [E / yes / gps] to accept and return to the previous menu.

Set Number Tag

Number Tag can be set in this menu.

Press a number key to input the number tag. Press [.] / no / pri] to clear the input.

Press [E / yes / gps] to accept the setting and return to the previous menu.

Note: The valid setting range is from 0 to 999. Blank means a number tag not assigned.

Set Lockout

This option allows you to lock or unlock the Close Call system. When the system is locked out, the scanner does not check it.

Unlocked	The system is unlocked.
Temporary L/O	The system is temporarily locked out.
Lockout	The system is locked out.

Press [E / yes / gps] to accept the selection and return to the previous menu.

Set Hold Time

This setting determines the maximum time the scanner is forced to hold and search this range before moving to the next scanning, even if there is no traffic on the frequencies. You can change it from 0 (the scanner checks all frequencies of the range regardless of time) to 255 seconds by using the number keys.

If you choose a setting other than "0", the scanner goes to next system or search when the hold time elapses. However, it does not go to the next one while receiving a signal.

Press [E / yes / gps] to accept the entry and return to the previous menu.

If you enter over "255" for the Hold Time, the scanner prompts "Out of Range" and "Set Max? (Y/N)". When [E / yes / gps] is pushed, maximum value 255 will be set.

It returns to the edit state, if you press [.] / no / pri].

Set CC Mode

These settings affect when CC actually operates. When it is set to "CC DND" or "CC Pri" with another mode, every 2 seconds the scanner will switch the filter settings to the ones set by the CC Bands option.

Off	Close Call is turned off for all modes.
CC DND	Close Call does not function while monitoring a transmission.
CC Pri	Close Call functions every 2 seconds even if there is a carrier.

Press [E / yes / gps] to set the mode and return to the previous menu.

Note: The Close Call function is not performed in Weather Mode and Tone-Out Mode.

Set CC Override

This mode determines how the scanner will behave when a Close Call signal is detected.

- On The scanner alerts (depending on the CC Alert setting) and displays "CC Found!" then immediately jumps to the Close Call frequency.
- Off The scanner alerts (depending on the CC Alert setting) and displays "CC Found!" and "Press FUNC Key" for the time set at Set CC Pause. If you press [FUNC] or [E / yes / gps] during this time, the scanner jumps to the Close Call frequency.

Detail of this setting : Close Call Search.

Press [E / yes / gps] to accept the entry and return to the previous menu.

Set CC Alert

You can edit these settings.

- Set Alert Tone
- Set Alert Light
- Set CC Pause

Press [E / yes / gps] to enter each item.

Set Alert Tone

This item can select the type and the level alert.

- Off Beep doesn't sound.
- Alert1-9 The scanner sounds Alert1-9 with CC found.

If you select Off, the scanner returns to the previous menu.

If you select Alert1-9, the scanner goes to Alert Level selection.

- Auto The alert is set to the same volume as normal audio.
- Level1-15 The alert is fixed to the selected audio level.

Press [E / yes / gps] to accept the entry and return to the previous menu.

Set Alert Light

You can set whether the scanner should have an alert light when it gets a Close Call hit.

Off
Blue
Red
Magenta
Green
Cyan
Yellow
White

If you select "Off", the scanner returns to the previous menu.

If you select an alert light color, the scanner goes to the Alert Light Pattern selection.

On	The alert light is set to on
Slow Blink	The alert light blinks slowly
Fast Blink	The alert light blinks fast

Press [E / yes / gps] to accept the entry and return to the previous menu.

Set CC Pause

This option can set time from the reception of a Close Call hit to when it returns to previous mode.

Turn [Scroll Control] to set from the following item.

3 sec
5 sec
10 sec
15 sec
30 sec
45 sec
60 sec
Infinite

Press [E / yes / gps] to accept the entry and return to the previous menu.

Set CC Bands

This setting controls the band filtering used during Close Call operation.

You can turn on or off the following bands.

VHF Low 1	:	On/Off	:	25.0000	- 53.9800 MHz
VHF Low 2	:	On/Off	:	54.0000	- 107.9000 MHz
Air Band	:	On/Off	:	108.0000	- 136.9916 MHz
VHF High 1	:	On/Off	:	137.0000	- 224.9800 MHz
VHF High 2	:	On/Off	:	225.0000	- 319.9500 MHz
UHF	:	On/Off	:	320.0000	- 512.0000 MHz
800MHz+	:	On/Off	:	763.0000	- 775.9937 MHz
				793.0000	- 823.9875 MHz
				849.0125	- 868.9875 MHz
				894.0125	- 960.0000 MHz
				1240.0000	- 1300.0000 MHz

Turn [Scroll Control] to move the cursor, and press [E / yes / gps] to change the setting.

On The scanner check Close Call in this Band.

Off The scanner does not check this Band.

Press [Menu] to return to the previous menu.

Priority Scan

You can set following items in this menu.

- Set Priority
- Set Interval
- MaxCHs/Pri-Scan

Press [E / yes / gps] to enter each setting.

Set Priority

This setting controls how the scanner treats Priority Channels.

You can select the following items.

- Off The scanner provides no special treatment for Priority Channels.
- On The scanner scans all unlocked Channels and also checks Priority Channels.
- Plus On The scanner scans only Priority Channels.

Press [E / yes / gps] to set the Priority function and return to the previous menu.

Set Interval

This menu, lets you set the priority scan active interval time.

Press the number keys to enter the time, press [. / no / pri] to clear the input.

Note: Valid input range is from 1 to 10 sec.

If you enter "0" sec for the interval time, the scanner prompts "Out of Range" and "Set Min?(Y/N)". Press [E / yes / gps] to select the minimum value (1 sec). Press [. / no / pri] to return to the editing state.

If you enter over "10" sec for the interval time, the scanner prompts "Out of Range" and "Set Max?(Y/N)". Press [E / yes / gps] to select the maximum value (10 sec). Press [. / no / pri] to return to the editing state.

MaxCHs/Pri-Scan

You can set the Maximum priority channel numbers that are scanned during one priority scan interrupt using this menu. If there are more scannable priority channels than the value you select, the channels are divided into more than one group and the scanner scans each group in turn.

Note: The valid set range is from 1 to 100 channels.

Press the number keys to input the number. Press [E / yes / gps] to store the setting.

If you enter "0" for the max priority scan channels, the scanner prompts "Out of Range" and "Set Min?(Y/N)". Press [E / yes / gps] to select the minimum value (1 channel). Press [. / no / pri] to return to the editing state.

If you enters over "100" for the max priority scan channels, the scanner prompts "Out of Range" and "Set Max?(Y/N)". Press [E / yes / gps] to select the maximum value (100 channels). Press [. / no / pri] to return to the editing state.

WX Operation

This menu lets you set the following items.

- Weather Scan
- Weather Alert
- Program SAME
- Set Delay Time
- Set Attenuator
- Set Audio AGC
- WX Alt Priority

Select "Weather Scan" and press [E / yes / gps] to start Weather Scan.

Select any other and press [E / yes / gps] to enter each setting.

Weather Scan

When this item is selected at WX Operation, the scanner exits from the Menu Mode and goes to Weather Scan Mode. Then it starts scanning the 10 Weather channels normally.

The scanner stops if there is a carrier. If the carrier is lost, it resumes scanning (See: WEATHER SCAN MODE)

Weather Alert

You can select how Weather Scan works. Select from "Alert Only", names of SAME groups and "All FIPS". If the names of the SAME groups are not changed from default setting, the displayed items are as follows.

- Alert Only
- SAME 1
- SAME 2
- SAME 3
- SAME 4
- SAME 5
- All FIPS

If you select Alert Only, the scanner immediately sounds a Weather Alert Siren (for Weather Alert Tone) when it detects the 1050 Hz Weather Alert Tone, then opens squelch and remains on the Weather Channel.

If you select one of the SAME Groups, the scanner attempts to decode the SAME data packets that precede the Weather Alert Tone. Then the scanner sounds a Weather Alert Siren (for Warning, Watch or Advisory) when the received County is the same as the programmed data. It then opens squelch and remains on the Weather Channel.

If you select All FIPS, the scanner sounds a Weather Alert Siren (for Warning, Watch or Advisory) when it decodes the SAME data packets. Then opens squelch and remains on the Weather Channel.

Press [E / yes / gps] to select and the scanner exits from Menu Mode. Then it goes to Weather Scan Mode with this selection.

Program SAME

You can edit the 5 SAME Groups. The names of SAME Groups are displayed as Menu Items. Default names as follows.

SAME 1
SAME 2
SAME 3
SAME 4
SAME 5

Select the Name and press [E / yes / gps] to go to Same Group Editing Menu.

SAME Group Settings

You can set the following items.

Edit Name
Edit County

Press [E / yes / gps] to go to each setting.

Note: The first line displays the name of the SAME Group.

Edit Name

You can name the SAME Group.

Refer to *FONT DATA* for the characters that *can* be entered.

Press [E / yes / gps] to accept the name entered. The scanner returns to the previous menu.

Edit County

Each SAME Group has 8 entries. You can edit the desired FIPS Code. Stored codes are displayed as Menu Items.

For example, if the SAME Group has "043221", "043227" and "-----", selectable items are as follows:

No.1 : 043221
No.2 : 043227
No.3 : -----
:
No.8 : -----

Select the item and press [E / yes / gps] to enter the editing state.

In the editing state, the editing cursor is displayed. Press the number keys to enter the FIPS code. The cursor moves to the right by entering number. Turn [Scroll Control] to choose the cursor position from the left end to next to right end character, or from left end to right end character when there are already entered up to limit of length. Press the decimal key to clear all numbers.

Press [E / yes / gps] to store the code and return to the previous menu.

Note: If you try to store the County before entering all 6 digits, that County is set to "-----" as blank.

Set Delay Time

This setting controls how long the scanner stays on the Weather Channel after a transmission ends before resuming.

Turn [Scroll Control] to select the delay time setting from the following list:

- 10 sec
- 5 sec
- 2 sec
- 0 sec
- 1 sec
- 2 sec
- 5 sec
- 10 sec
- 30 sec

Then press [E / yes / gps] to accept and return to the previous menu.

Set Attenuator

You can attenuate RF reception on the frequency.

- On The frequency will be attenuated.
- Off The frequency will not be attenuated.

Press [E / yes / gps] to accept the selection and return to the previous menu.

Set Audio AGC

When Audio AGC function is “On”, the scanner judges volume of the signal and changes the volume automatically.

You can turn “On” or “Off” AGC for Analog audio.

Analog : On / Off

- On Audio AGC is on.
- Off Audio AGC is off.

Turn [Scroll Control] to focus the cursor on the item. Press [E / yes / gps] to change the setting and press [Menu] to return to the previous menu.

WX Alt Priority

This setting determines how the scanner treats the Weather Channels in Scan/Hold Mode Search/Hold Mode and Close Call Mode.

- On The scanner checks the Weather Channels every 5 seconds to check for the presence of a 1050 Hz Weather Alert Tone.
- Off The scanner does not check the Weather Channels.

Press [E / yes / gps] to set this setting and return to the previous menu.

Tone-Out for ...

This menu lets you set the following items.

- Tone-Out Standby
- Tone-Out Setup

Select “Tone-Out Standby” to start monitoring the Tone-out Frequency.

Select “Tone-Out Setup” to go to *Tone-Out Setup*.

Tone-Out Standby

When this item is selected at *Tone-Out for ...*, the scanner exits from Menu Mode and goes to Tone-Out standby Mode.

Tone-Out Setup

You can edit the 10 Tone-Out channels.

The Names of the Tone-Out channels are displayed as Menu Items.

Default names as follows.

- Tone-Out 1
- Tone-Out 2
- Tone-Out 3
- :
- Tone-Out 10

Select the Name and press [E / yes / gps] to go to *Tone-Out Settings*.

Tone-Out Settings

You can edit these settings.

- Edit Name
- Set Frequency
- Set Tone
- Set Delay Time
- Set Alert
- Set Audio AGC

Press [E / yes / gps] to go to each setting.

Note: The first line displays the name of selected Tone-Out channel.

Edit Name

You can name the Tone-Out channel.

Refer to *FONT DATA* for the characters that *can be entered*.

Press [E / yes / gps] to accept the name entered. The scanner returns to the previous menu.

Set Frequency

You can set the following items.

- Edit Frequency
- Set Modulation
- Set Attenuator

Press [E / yes / gps] to go to each setting.

Edit Frequency

If you select to edit the frequency, the scanner displays the current frequency in edit mode.

Press the number keys and [. / no / pri] to enter the frequency.

Press [E / yes / gps] to return to the previous menu.

Set Modulation

You can select the modulation from following settings.

- Auto* The scanner uses the modulation normal for the frequency's band.
- NFM The scanner uses Narrowband FM demodulation.
- FM The scanner uses FM demodulation.

Press [E / yes / gps] to accept the entry and return to the previous menu.

Set Attenuator

You can attenuate RF reception on the frequency.

- On The frequency will be attenuated.
- Off The frequency will not be attenuated.

Press [E / yes / gps] to accept the selection and return to the previous menu.

Set Tone

You can set the following items.

- Edit Tone A
- Edit Tone B

Press [E / yes / gps] to go to each setting.

Edit Tone

When you select "Edit Tone A" or "Edit Tone B", you can set the frequency for Tone A or B from 250 to 3500 Hz, and 0Hz.

Press [E / yes / gps] to set the Tone frequency and it remains on Tone A / B selection.

Set Delay Time

This setting controls how long the scanner stays on Mute Off state after a transmission ends.

Turn [Scroll Control] to select setting value from:

- 0 sec
- 1 sec
- 2 sec
- 5 sec
- 10 sec
- 30 sec
- Infinite

Then press [E / yes / gps] to accept and return to the previous menu.

Set Alert

You can set these options in this menu.

- Set Alert Tone
- Set Alert Light

Press [E / yes / gps] to enter the setting.

Set Alert Tone

You can set whether the scanner should sound an Alert Tone when a tone-out channel becomes active*.

- | | |
|-----------|--|
| Off | No alert sounds. |
| Alert 1-9 | The scanner sounds Alert1-9 with the Channel becomes active. |

If you select "Off", the scanner returns to the previous menu.

If you select "Alert1-9", the scanner goes to Alert Level selection.

- | | |
|-----------|--|
| Auto | The alert is set to the same volume as normal audio. |
| Level1-15 | The alert is fixed to the selected audio level. |

Press [E / yes / gps] to accept the entry and return to the previous menu.

Set Alert Light

You can select whether the scanner should have alert light when a tone-out Channel becomes active*.

- Off
- Blue
- Red
- Magenta
- Green
- Cyan
- Yellow
- White

If you select "Off", the scanner returns to the previous menu.

If you select an alert light color, the scanner goes to the Alert Light Pattern selection.

On	The alert light is set to on
Slow Blink	The alert light blinks slowly
Fast Blink	The alert light blinks fast

Press [E / yes / gps] to accept the entry and return to the previous menu.

*"Active" means that the scanner detects Tones and Mute state is set to Off.

Set Audio AGC

When Audio AGC function is "On", the scanner judges volume of the signal and changes the volume automatically.

You can turn "On" or "Off" AGC for Analog audio.

Analog : On / Off

On	Audio AGC is on.
Off	Audio AGC is off.

Turn [Scroll Control] to focus the cursor on the item. Press [E / yes / gps] to change the setting and press [Menu] to return to the previous menu.

Wired Clone

Connect two BCD396XTs and select this menu to copy and override all data from one to another.

Master
Slave

The scanner you set to Master's data will be copied to the scanner you set to Slave. Then go to Wired Clone Mode. (See: WIRED CLONE MODE)

Settings

You can set the following items from this menu.

- Set Backlight
- Adjust Key Beep
- Battery Option
- Adjust Audio AGC
- Adjust Contrast
- Set C-CH Output
- Set GPS Format
- Set Serial Port
- Band Defaults
- P25 LP Filter
- See Scanner Info

Press [E / yes / gps] to enter each setting.

Set Backlight

This menu has the following items.

- Set Mode
- Set Dimmer
- Set Color

Press [E / yes / gps] to enter each setting.

Set Mode

This option can be used to set the backlight activation mode.

You can select from the following options.

- 10 sec
- 30 sec
- Squelch
- Keypress
- Infinite

Press [E / yes / gps] to accept the data and return to the previous menu.

Set Dimmer

This option can be used to set the brightness level of the display.

You can select from the following options.

- High
- Middle
- Low

Press [E / yes / gps] to accept the data and return to the previous menu.

Set Color

This option can be used to select the backlight color.

- Blue
- Red
- Magenta
- Green
- Cyan
- Yellow
- White

Press [E / yes / gps] to accept the data and return to the previous menu.

Adjust Key Beep

Adjusts the beep tone volume level.

Auto	Key Beep is set to the same volume as normal audio.
Level 1–15	Key Beep is fixed to the selected volume level.
Off	Key beep is Off.

Press [E / yes / gps] to set the Beep volume level and return to the previous menu.

Battery Option

This menu has the following items.

- Set Battery Save
- Set Charge Time

Press [E / yes / gps] to enter each setting.

Set Battery Save

This option can be used to set the battery save feature.

On	Set battery save on
Off	Set battery save off

Press [E / yes / gps] to accept the selection and return to the previous menu.

Set Charge Time

This option can be used to set the battery charge time.

Press the number keys to enter the charge time from 1 to 16 hours.

Press [E / yes / gps] to accept the data and return to the previous menu.

Adjust Audio AGC

You can set the following items.

- Analog AGC
- Digital AGC

Press [E / yes / gps] to enter each setting.

Analog AGC

You can set the following items in this menu.

- Response Time
- Reference Gain
- Gain Range

Press [E / yes / gps] to enter each setting.

Response Time

In this menu, you can set the Response Time for Analog AGC.

Selectable values are from -4 to +6, by steps of 1.

Press [E / yes / gps] to accept the selection and return to the previous menu.

Reference Gain

In this menu, you can set the Reference Gain for Analog AGC.

Selectable values are from -5 to +5, by steps of 1.

Press [E / yes / gps] to accept the selection and return to the previous menu.

Gain Range

In this menu, you can set the Gain Range for Analog AGC.

Selectable values are from 0 to 15, by steps of 1.

Press [E / yes / gps] to accept the selection and return to the previous menu.

Digital AGC

This menu lets you set the following items.

- Response Time
- Reference Gain

Press [E / yes / gps] to enter each setting.

Response Time

In this menu, you can set the Response Time for Digital AGC.

Selectable values are from -8 to +8, by steps of 1.

Press [E / yes / gps] to accept the selection and return to the previous menu.

Reference Gain

In this menu, you can set the Reference Gain for Digital AGC.

Selectable values are from -5 to +5, by steps of 1.

Press [E / yes / gps] to accept the selection and return to the previous menu.

Adjust Contrast

This function sets the contrast of the display from "Contrast 1" to "Contrast 15".

Press [E / yes / gps] to accept the selection and return to the previous menu.

Set C-CH Output

The scanner can output the data stream on control channel by using this function.

Off	data stream is not outputted
On	data stream is outputted
Extend	data stream and description are outputted

Press [E / yes / gps] to accept the data and return to the previous menu.

(See *Control Channel Data Stream Output* for detail)

If the baud rate is slow, the scanner cannot output all data streams. Therefore it is recommended you use a baud rate of 115200 bps.

Set GPS Format

You can set the following items for GPS.

- Set Pos Format
- Set Time Format
- Set Time Zone
- Set Unit

Press [E / yes / gps] to go to each setting menu.

Set Pos Format

The option sets the position format for latitude and longitude.

- DMS:DDD⁰MM'SS.ss
- DEG:DDD.dddddd

Note: This setting changes all Location Input displays and the GPS Mode display.

Press [E / yes / gps] to accept the selection and return to the previous menu.

Set Time Format

This option sets the time format.

- 12H The scanner uses 12-hour format.
- 24H The scanner uses 24-hour format.

Press [E / yes / gps] to accept the data and return to the previous menu.

Set Time Zone

This option sets the time zone and daylight savings time.

You can set an offset value from GMT from “-14.0 H” to “+14.0 H” in 0.5H increments.

Press [E / yes / gps] to accept the selection and return to the previous menu.

Set Unit

This option selects the unit that will be active for location range, elevation and speed of the GPS feature.

- mile
- km

Note: This selection also changes the unit used for location range and speed.

Press [E / yes / gps] to accept the selection and return to the previous menu.

Set Serial Port

You can set the serial port speed from the following items.

- 4800 bps
- 9600 bps
- 19200 bps
- 38400 bps
- 57600 bps
- 115200 bps
- Off

Press [E / yes / gps] to accept the selection and return to the previous menu.

Band Defaults

This menu lets you set the default modulation and default step for each band.

The band settings are shown as menu items.

- 25.0:AM / 5.0
- 26.9:AM / 5.0
- 27.4:AM / 5.0
- 28.0:NFM/ 20.0
- 29.7:NFM/ 10.0
- 50.0:NFM/ 20.0
- 54.0:WFM/ 50.0
- 72.0:FM / 5.0
- 76.0:WFM/ 50.0
- 88.0:FMB/100.0
- 108.0:AM / 8.3
- 137.0:NFM/ 12.5
- 144.0:NFM/ 5.0
- 148.0:NFM/ 12.5
- 150.8:NFM/ 5.0
- 162.0:NFM/ 12.5
- 174.0:WFM/ 50.0
- 216.0:NFM/ 20.0
- 225.0:AM / 25.0
- 380.0:NFM/ 12.5
- 400.0:NFM/ 12.5
- 406.0:NFM/ 12.5
- 420.0:NFM/ 12.5
- 450.0:NFM/ 12.5
- 470.0:NFM/ 12.5
- 763.0:NFM/ 6.25
- 793.0:NFM/ 6.25
- 806.0:NFM/ 12.5
- 849.0:NFM/ 12.5
- 894.0:NFM/ 12.5
- 1240.0:NFM/ 25.0

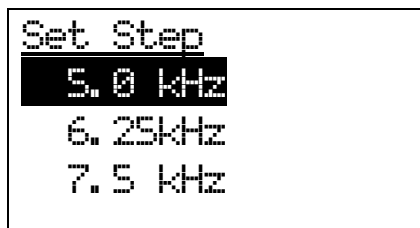
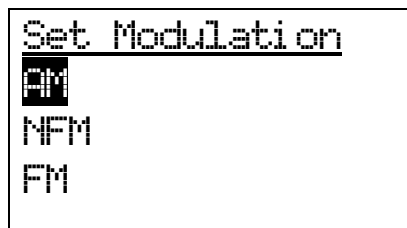
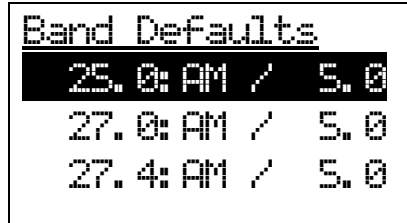

Turn [Scroll Control] to focus the cursor on the band you want to change. Then, press [E / yes / gps] to enter the modulation setting menu.

The following modulation setting values will be shown.

AM	set the current band as AM modulation
NFM	set the current band as NFM modulation
FM	set the current band as FM modulation
WFM	set the current band as WFM modulation
FMB	set the current band as FMB modulation

Turn [Scroll Control] to select the value, press [E / yes / gps] to set the selection and go to the Step Setting menu.

Selectable step values are:

- 5.0 kHz
- 6.25kHz
- 7.5kHz
- 8.33kHz
- 10.0 kHz
- 12.5 kHz
- 15.0 kHz
- 20.0 kHz
- 25.0 kHz
- 50.0 kHz
- 100.0 kHz

Turn [Scroll Control] to select the value, press [E / yes / gps] to set the selection and return to the Band Defaults setting menu.

P25 LP Filter

This option can be used to activate the P25 Low Pass Filter feature.

On	P25 Low Pass Filter on
Off	P25 Low Pass Filter off

Press [E / yes / gps] key to accept the selection and return to the previous menu.

See Scanner Info

This menu lets you see some information about the scanner, including the memory usage.

Select from the following items.

- % Memory Used
- Firmware Version

Press [E / yes / gps] to go to each setting.

% Memory Used

When you select this option, the scanner displays the percent of memory that is used, the number and percent of systems, sites and channels that are created.

This display is as follows.

Memory Used:	62%
SYSTEM 135:	27%
SITE 921:	92%
CHN 15758:	63%

The Value is displayed until you press any key and return to the previous menu.

Firmware Version

When you select this option, the scanner displays the firmware version as "Version ###.###".

And the serial number of the unit is displayed as "SN#####" on the bottom of the screen.

Note : The serial number includes 14 digits.

Press any key to return to the previous menu.

SCAN MODE

Display during Scan Mode

The LCD display in Scan mode is as follows.

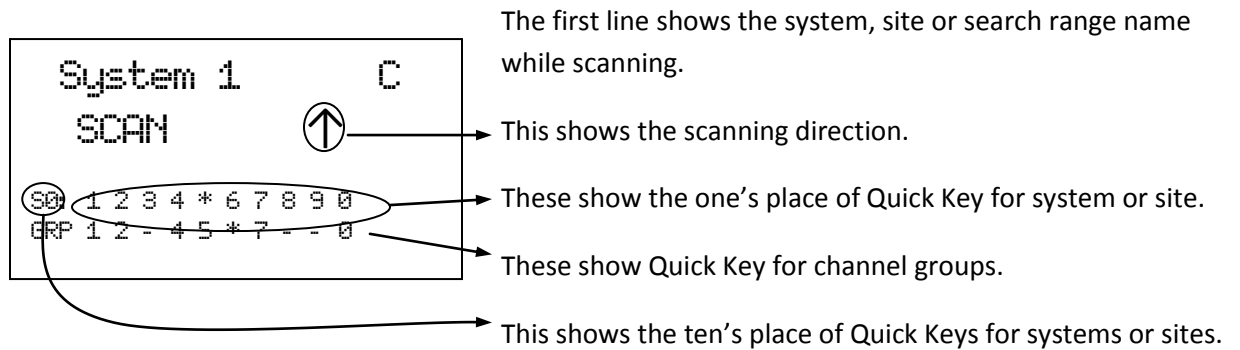

- SCAN : This scrolls to the left from the right while Scan Mode.
- S : This icon appears with icons of Quick Key numbers for Systems / Sites.
- GRP : This icon appears with icons of Quick Key number for Groups.

Startup Key Operation

The scanner can change the lockout state for each system or each site when you turn it on while pressing a number key.

First, you set the Startup Key for each system or each site.

You can set one key from 0 to 9 for each system or site.

If you hold a number key while turning on the scanner, it displays the following message after displaying the copyright message.

```
Startup Config.  
Key No. 1  
Processing  
Please Wait
```

Systems and Sites whose Startup Key matches the one you press are unlocked and systems and sites whose Startup Key do not match are locked out. Systems and Sites whose startup key are assigned "." are not affected (if they were locked or unlocked before, their lockout status does not change).

Quick keys for the matching systems and sites are also enabled.

Start Scanning

When you press [Scan / srch] to go to the Scan Mode the scanner scans all sites and systems that are not locked out and whose System/Site quick key is enabled. Then, the scanner scans all unlocked Service and Custom Search Ranges whose quick keys are enabled (Search with Scan). After Search with Scan, the scanner scans CC Hits System.

While in the Scan Mode, the first line displays currently scanned system, site or search range name and the second line displays "SCAN" (for conventional System) or "ID SCAN", "ID SEARCH" (for trunked System) scrolling from the right to the left, or a search frequency. Disabled Quick Keys are displayed as "*". The Quick Key for the Current System blinks.

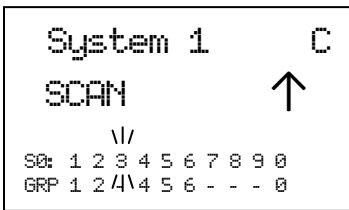

Scan for conventional system

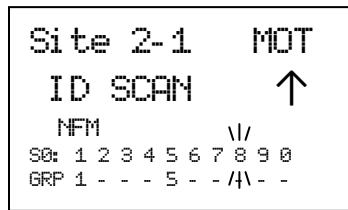

ID Scan for trunked system

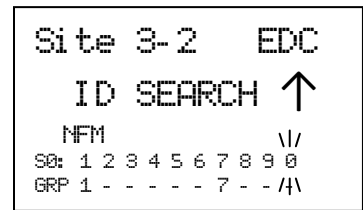

ID Search for trunked system

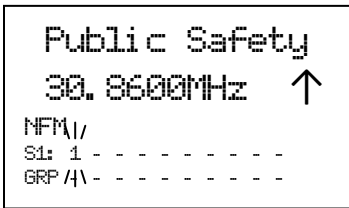

Service Search in Search with Scan

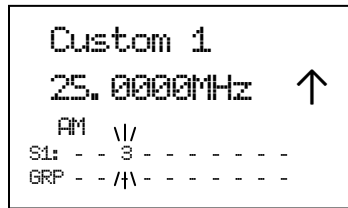

Custom Search in Search with Scan

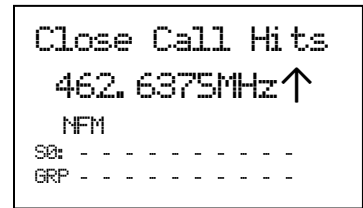

Close Call Hits with Scan

When all channels are locked out directly or indirectly*, the scanner displays "Nothing to Scan" and the scanner stays in the Scan Mode.

*"A channel is locked out directly or indirectly" means:

1. The channel is locked out.
2. The group containing the Channel is locked out.
3. The Quick Key for groups to which that group belongs is disabled.
4. The system / site containing the channel is locked out.
5. The Quick Key for systems / sites to which that system belongs is disabled.

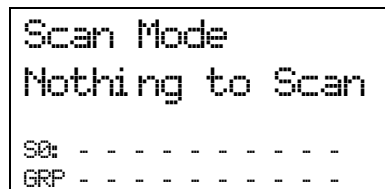

If the Channels are unlocked by cancellation of any of the above-mentioned states, the scanner will start scanning immediately.

Scanning Order

First, systems belonging to Quick Key 1 are scanned. Then systems that belong to Quick Key 2, ..., 9, 0, 11, ..., 19, 10, 21, ..., 99, 90 are scanned in order. Systems with no Quick Key are scanned last.

When the scanning of all systems ends, the scanner starts Service Search for any unlocked/enabled searches. The scanner searches Public Safety, News, . . . , Military Air and Special in turn.

When Service Search ends, it starts Custom Search. The scanner searches Custom Search from range 1 to 10 in turn.

After Custom Search ends, the scanner scans a system that is named "Close Call Hits*"

*This is a system where the scanner automatically stores the frequencies found by Close Call.

(See *CC Hit with Scan* for details.)

If "Close Call Hits" system has no frequencies, the scanner does not scan this system. After the scanner finishes scanning "Close Call Hits" system, the scanner scans from top system again.

You can change the scanning direction by turning [Scroll Control].

The scanning order of the systems / sites belonging to the same Quick Key is the order registered to that Quick Key. The scanning order of the systems / sites belonging to no Quick Key is the order set to none.

When a system / site is created, the scanner automatically sets the Quick Key to none. So, if you do not change the Quick Key setting, the scanning order will be the order of system / site creation.

The scanning order of groups in a conventional system also depends in the order set to any Group Quick Key or none. Groups with no Group Quick Key set are scanned in the order of group creation.

The scanning order of Channels in a conventional system's channel group depends in the order of Channel creation.

However, locked out or disabled items* are not scanned.

*Locked out or disabled items means locked out System / Sites, locked out Channel Groups, locked out Channels, disabled System/Site Quick Keys and disabled Group Quick Keys.

Scanning Operation

Quick Key Operation

For Conventional Systems, the SQK is set at the system level. However, for trunked systems, the SQK is set at the site level instead of the system level.

In the display, enabled SQKs show their number; disabled SQKs show "*"; SQKs with no system assigned show "-".

During scanning, you can enable or disable single digit SQKs by pressing the corresponding [1 - 9, 0] key.

For two-digit SQK's first press [./no/pri], then enter the two digits to enable or disable that SQK.

Systems belonging to disabled SQKs are not scanned.

*You cannot enable or disable an SQK if no system or site is assigned to it.

*The displayed GQKs (channel Group Quick Keys) show the status of GQKs for the system currently being scanned.

For example, the scanner displays as follows if the SQKs "3", "4", "6", and "9" are disabled.

```
System 1      C
SCAN         ↑
SQ: 1 2 * * 5 * 7 8 * 0
GRP 1 2 3 4 5 6 7 8 9 0
```

The details of scanning depend on whether the System is a conventional System or a trunked System.

The SQK's Ten's blinks when you press [./no/pri] (until you enter the SQK's first digit).

```
System 1      C
SCAN         ↑
SQ: 1 2 * * 5 * 7 8 * 0
GRP 1 2 3 4 5 6 7 8 9 0
```

If you do not press a digit within 2 seconds of pressing [./no/pri], the entry times out and nothing is changed.

Scan for Conventional Systems

In conventional scanning, the scanner steps through each unlocked channel. If there is activity on the channel, the scanner monitors activity until the transmission ends.

While monitoring the transmission, the first line alternates between the current system name and current group name every 1 second. The second line displays the current channel name.

The Quick Keys for the current system and channel group blink. Furthermore, the attenuation setting, modulation and CTCSS/DCS/P25 NAC data of current channel are displayed.

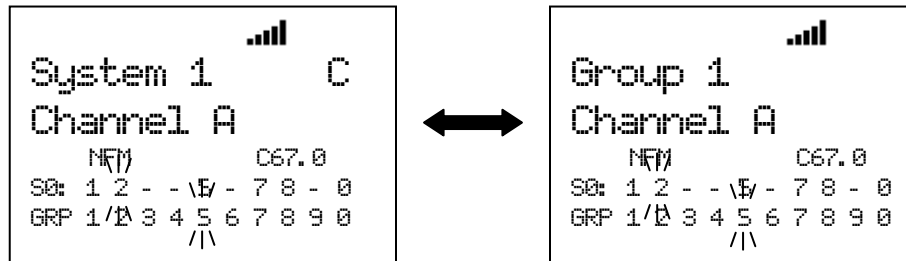

Even if the transmission ends, the scanner holds on the channel for the duration of the system delay time. After the system delay time elapses, if there is no transmission the scanner resumes scanning.

*If CTCSS/DCS or P25 NAC is applied to a channel, the received signal must match for the scanner to hold on the transmission. (Not for AM, WFM or FMB modulation.)

The scanner continuously scanning each system for the duration of the system's system hold time setting. However, the scanner surely scans all unlocked channels at least 1 time, even if this takes longer than the set time.

The scanner will advance to the next system once the scanner scans all unlocked channels and the system hold time has elapsed.

Scan for Trunked Systems

In trunked scanning, the scanner holds on the control channel (C-Ch) and decodes the TGIDs as they become active.

*If C-Ch Only is set to on at Set C-Ch Only for the site, trunking is performed using control channel data only. A voice channel (V-Ch) does not have to be programmed into memory. (Motorola Systems only)

While scanning, press Function then [Scan / srch] to toggle between ID Scan and ID Search. You can also change this mode through the Menu. (See: ID Scan/Search.)

ID Search :

If a TGID does not match any locked out TGID, the scanner goes to the V-Ch and monitors the transmission until it ends.

ID Scan :

If a TGID matches a TGID stored in an unlocked channel, the scanner goes to the V-Ch and monitors the transmission until it ends.

While monitoring a TGID already stored into the Memory, the first line of the display alternates between the current site name and current channel group name every 1 second, and second line displays the current channel name. The Quick Key numbers for the current site and group blinks.

While monitoring a TGID not stored into the Memory, the first line displays current site name, and the second line displays the current TGID. The current Site and Group Quick Keys blink.

While monitoring the TGID:

Press [Scan / srch] or turn [Scroll Control] to return to the C-Ch. Then the scanner waits for a moment on the C-Ch to see if another TGID is active. If the scanner finds another TGID, it monitors the found TGID. But if there is only the TGID that was being monitored just before, it monitors that TGID again.

Press [L/O] to lock out the TGID and store it to the list of ID Lockouts of the system (See: Clr All L/O IDs). This lock out information is common to every site in the system. Then the scanner returns to the C-Ch.

If the transmission ends, it returns to the C-Ch and exclusively listens for the last-active TGID until the site delay time expires.

After the system delay time elapses, the scanner checks to see if the Site Hold time has elapsed. If so, the scanner advances to the next System or Site. If the Site Hold Time has not elapsed, the scanner continues to monitor the C-Ch for TGID activity.

Lockout Operation

You can lock out each site but cannot lock out the system to which the site belongs.

In Trunked Systems (except EDACS SCAT system), one system can have multiple sites and those sites share the same TalkGroup IDs.

If you lock out a TGID, the TGID is locked out for all sites in the system.

ID Display Format

The scanner displays received ID in the following format on the second line.

Normal ID

The scanner displays as "ID:xxxx" for no-named TGID.

Example)	MOT Type I ID	:	ID:101-1	
	MOT Type II	:	ID:12345	(Decimal Format)
		:	ID:123 h	(Hexadecimal Format)
	P25 ID	:	ID:12345	(Decimal Format)
		:	ID:1234h	(Hexadecimal Format)
	EDACS	:	ID:01-023	(AFS Format)
		:	ID:147	(Decimal Format)
	LTR	:	ID:0-20-254	

I-Call

The scanner displays ID as "ID:xxxxxx" for no-named TGID. In order to show that ID is I-Call, "i" is displayed on the left end of the ID.

Example)	MOT Type I I-Call	:	ID:i12345	
	MOT Type II	:	ID:i12345	(Decimal Format)
		:	ID:i1234h	(Hexadecimal Format)
	P25 I-Call	:	ID:i12345678	(Decimal Format)
		:	ID:i123456h	(Hexadecimal Format)
	EDACS I-Call	:	ID:i12345	

I-Call wild card (i0)

The scanner will display the received I-Call for wild card.

Example)	I-Call wild card	:	ID:i0	(while scanning)
		:	ID:i123456	(when it receives a ID)

MOT Individual Call

The scanner displays both IDs under communication as "ID:xxxxxx-yyyyyy".

In order to show that IDs are Individual Call, "i" is displayed on the left end of IDs.

Example)

MOT Type I Individual Call	:	ID:i12345-i23456	
MOT Type II	:	ID:i12345-i23456	(Decimal Format)
	:	ID:i1234h-i2345h	(Hexadecimal Format)
P25 Individual Call	:	ID:i12345678 SRC	
	:	ID:i23456789 DST	(Decimal Format)
	:	ID:i123456h SRC	
	:	ID:i234567h DST	(Hexadecimal Format)

*If the left side ID is already named, the scanner only displays that ID's name.

*The scanner alternately displays ID:XXXXXXXX SRC(or ID:XXXXXXh SRC) and ID:YYYYYYYY DST(or ID:YYYYYYh DST) during a P25 individual call.

PATCH ID

The scanner displays a PATCH list IDs and received PATCH ID as "ID:xx-xxx yy-yyy".

(xx-xxx : One of the PATCH list IDs, yy-yyy: received PATCH ID)

Example)	EDACS PATCH ID:	ID:01-012 00-002
	MOT Type II:	ID:42000 42016

*If the first PATCH list ID is already named, the scanner only displays that ID's name.

PARTIAL ID

The scanner displays the wild card portion of a PARTIAL ID as "-" in ID scanning.

When the scanner finds the ID that matches the PARTIAL ID, it displays the full received ID.

Example)	PARTIAL ID:	ID:01-01-	(while scanning)
		ID:01-015	(when it receives a ID)

Quick Save for ID Search

Press [E / yes / gps] to quickly store a TGID when the scanner stops on the TGID in ID Search.

The scanner prompts "Quick TGID Save?".

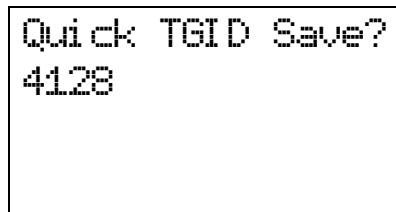

```
Quick TGID Save?  
4128
```

Press [E / yes / gps] to store the TGID. The scanner creates a channel group named "Qck Save Grp" in the current system. The TalkGroup ID is stored in that channel group.

If you want to select another channel group to stores the TGID, press [./ no / pri]. Then select the group to store the channel into. The scanner stores it in the selected channel group.

Trunking Activity Indicators (Display Mode 3)

The scanner shows trunking activity when held on the C-Ch.

Press [6 / RIGHT / disp] in Function Mode to change the Display Mode in Scan Hold Mode. (See SCAN HOLD MODE.)

In EDACS and LTR systems, the order of indicators is the order of LCN.

In Motorola systems, it is the order of the frequency programming.

*This mode does not work for EDACS SCAT Systems. Only the C-CH blinks in Motorola Systems you've programmed using C-CH Only Mode.

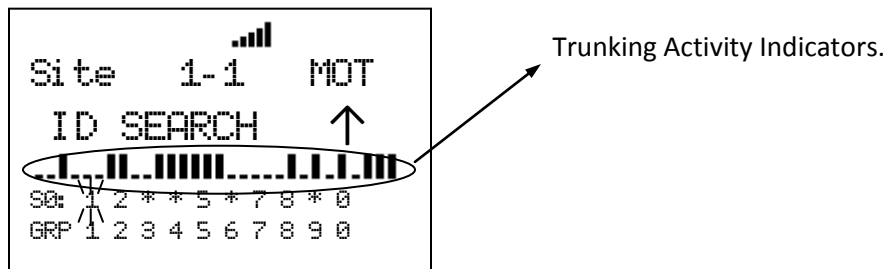

When the scanner receives a trunked system channel grant, the V-Ch blinks and the C-Ch lights. The scanner has 30 Channel Activity Indicators to visualize trunked system activity. This shows which site frequencies are in use.

The following figure shows that the scanner is staying on LCN1 and LCN3 and LCN4 are active.

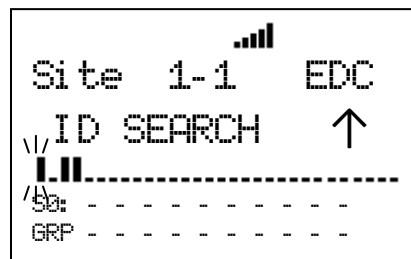

While the scanner is staying on a V-Ch, the voice channel blinks and its C-Ch turns on.

The following figure shows that the scanner is staying LCN3 and LCN1 is the control channel.

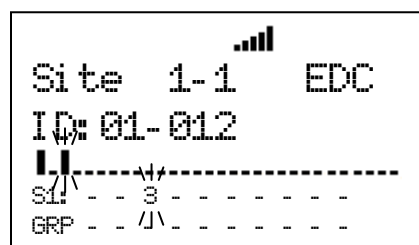

Location Based Scanning

This operation controls the lockout state for each group or site when the scanner is connected to a GPS unit.

This works automatically based on the location data from GPS when the feature is set to "On" in Set GPS Enable.

If the scanner goes within the location's range for a group or site, the scanner displays "Location Unlock" on the first line and the group name or the site name on second line.

```
GPS
Location Unlock
Site 1-1 MOT
SQ: - - - - -
GRP - - - - -
```

When the scanner goes outside the set range, the group or site is automatically temporarily locked out.

The scanner displays "Location L/O" on first line and the group name or the site name on second line.

```
GPS
Location L/O
Site 1-1 MOT
SQ: - - - - -
GRP - - - - -
```

This operation does not affect systems/sites whose SQK is disabled.

If a GPS is detected as soon as the scanner is turned on, the scanner displays "GPS CONNECTED" instead of displaying individual lock/unlock messages for groups and sites. It applies the location-based rules to all systems at one time.

```
GPS
GPS CONNECTED
SQ: - - - - -
GRP - - - - -
```

Control Channel Data Stream Output

The scanner can output the data stream on the control channel. You can turn on this feature in the menu Set C-CH Output. When it is active, the scanner will output the data stream whenever it is receiving a control channel. Also, for Motorola analog systems, the scanner will output the low speed data stream while receiving a voice channel.

Data Stream Output: ON

When data stream output is set to on, the scanner will output the data stream in the following format:
<Msg Type>,<CC data>.

Data Stream Output: Extend

When data stream output function is set to extend, the scanner will output the data stream in the following format: <Msg Type>,<CC data>.,<decoded description>.

<Msg Type>=

ASCII character (3 chars):

MOT (Motorola)

EDW (EDACS Wide)

EDN (EDACS Narrow)

LTR

P25 (Motorola Digital)

<CC data> =

OSW Data on Control Channel. It is different each Trunk System Type.

[MOT System]

MOT,<cmd>,<prv>,<id>

<cmd> = command or LCN (Hex 3 digits, 10 bits)

<prv> = private bit (1 bit)

<id> = ID (Hex 4 digit, 16 bits)

For example:

MOT,15C,0,D110

[ED Wide/Narrow]

EDW,,<cc>,<pppppp>

 = block number in a OSW (0 or 1)

<cc> = command (Hex 2 digits, 6 bits)

<pppppp> = message (Hex 6 digits, 22 bits)

For example:

EDW,0,3B,238333

EDN,0,3B,238333

Note: For EDACS narrow systems, the indicator will change from EDW to EDN.

[LTR System]

LTR,<A>-<GG>-<HH>-<III>-<FF>

<A> = Area Number (0 or 1)

<GG> = Goto Repeater Number (Hex 2 digits, 5 bits)

<HH> = Home Repeater Number (Hex 2 digits, 5 bits)

<III> = ID Number (Hex 2 digits, 8 bits)

<FF> = Free Repeater Number (Hex 2 digits, 5 bits)

For example:

LTR,0-01-01-FA-02

[P25]

P25,<X1X2X3X4X5X6X7X8X9XAXBXC>

<X1-XC> = message (Hex 24 digits, 96 bits)

For example:

P25,34007502403201ED251EDB45

[MOT Subaudio]

MOT,<id>

<id> = ID (Hex 4 digit, 16 bits)

For example:

MOT,D110

<decoded description>

For Motorola system:

Decoded Description	Remark
,CNM TG-tttt CH-ccc VC-ffffff	Call for Talk Group tttt = Talk Group ID (Hex 4 digits, 16 bits) ccc = LCN (Hex 3 digits, 10 bits) ffffff = Frequency (BCD 8 digits)
,CIP TG-tttt CH-ccc VC-ffffff	Call for ICALL tttt = Talk Group ID (Hex 4 digits, 16 bits) ccc = LCN (Hex 3 digits, 10 bits) ffffff = Frequency (BCD 8 digits)
,CIV TG-tttt TGR-dddd CH-ccc VC-ffffff	Call for ICALL (Individual Call) tttt = Talk Group ID (Hex 4 digits, 16 bits) dddd = Talk Group ID for Receiver (Hex 4 digits, 16 bits) ccc = LCN (Hex 3 digits, 10 bits) ffffff = Frequency (BCD 8 digits)
,CPT TG-tttt CH-ccc VC-ffffff	Call for Patch/Multiselect tttt = Talk Group ID (Hex 4 digits, 16 bits) ccc = LCN (Hex 3 digits, 10 bits) ffffff = Frequency (BCD 8 digits)
,EVM	Event Command for Multiple OSW
,SID-ssss	System ID ssss = System ID (Hex 4 digits)
,PAT-pppp MEM-mmmm	Patch List Update pppp = Patch/Multiselect ID (Hex 4 digits, 16 bits) mmmm = Member ID (Hex 4 digits)
,SIT-nn	Site Number nn = Site Number (Hex 2 digits, 6 bits)
,CCH CH-ccc CC-ffffff	Control Channel ccc = LCN (Hex 3 digits, 10 bits) ffffff = Frequency (BCD 8 digits)

For EDACS system:

Decoded Description	Remark
,CNM TG-ttt CH-cc VC-ffffff	Call for Talk Group ttt = Talk Group ID (Hex 3 digits, 11 bits) cc = LCN (Hex 2 digits, 5 bits) ffffff = frequency (BCD 8 digits)
,CIP TG-tttt CH-cc VC-ffffff	Call for ICALL tttt = Unit ID (Hex 4 digits, 14 bits) cc = LCN (Hex 2 digits, 5 bits) ffffff = frequency (BCD 8 digits)
,CPT TG-ttt CH-cc VC-ffffff	Call for Patch tttt = Patch ID (Hex 3 digits, 11 bits) cc = LCN (Hex 2 digits, 5 bits) ffffff = frequency (BCD 8 digits)
,PAT-ppp MEM-mmm	Patch List Update ppp = Patch ID (Hex 3 digits, 11 bits) mmm = Member ID (Hex 3 digits, 11 bits)
,SIT-ss	Site ID ss = Site ID (Hex 2 digits, 6 bits)

For LTR system:

Decoded Description	Remark
,CAL TG-a-hh-dd Free-ee CH-gg VC-ffffff	Call for Talk Group a = Area (Hex 1 digits, 1 bit) hh = Home Ch (Hex 2 digits, 5 bits) dd = ID (Hex 2 digits, 8 bits) ee = Free Ch (Hex 2 digits, 5 bits) gg = Goto Ch (Hex 2 digits, 5 bits) ffffff = Frequency (BCD 8 digits)
,DIS TG-a-hh-dd Free-ee	Disconnect Code a = Area (Hex 1 digits, 1 bit) hh = Home Ch (Hex 2 digits, 5 bits) dd = ID (Hex 2 digits, 8 bits) ee = Free Ch (Hex 2 digits, 5 bits)

For P25 system:

Decoded Description	Remark
,IU N-n B-bbbbbbbb S-sss	Identifier Update n = Identifier Number bbbbbbbb = Base Frequency (Hex 8 digits, 32 bits) sss = Spacing (Hex 3 digits, 10 bits)
,IUVU N-n B-bbbbbbbb S-sss	Identifier Update for VHF/UHF n = Identifier Number bbbbbbbb = Base Frequency (Hex 8 digits, 32 bits) sss = Spacing (Hex 3 digits, 10 bits)
,CNM TG-tttt CH-ccc VC-ffffff	Group Voice Channel Grant Update tttt = Talk Group ID (Hex 4 digits, 16 bits) cc = LCN (Hex 3 digits, 12 bits) ffffff = Frequency (BCD 8 digits)
,CIV TG-ttttt TGR-ddddd CH-ccc VC-ffffff	Call for ICALL ttttt = Unit ID (Hex 6 digits, 24 bits) dddddd = Unit ID of Reciever (Hex 6 digits, 24 bits) cc = LCN (Hex 3 digits, 12 bits) ffffff = Frequency (BCD 8 digits)
,SID-ssss SUB-uu SIT-ii	System ID ssss = System ID (Hex 4 digits, 16 bits) uu = Sub System ID (Hex 2 digits, 7 bits) ii = Site Number (Hex 2 digits, 7 bits)
,WACN-wwwww	WACN ID wwwww = WACN ID (Hex 5 digits, 20 bits)

Temporary System Hold

*For trunked systems, “system” should be read as “site” in this section.

**In Temporary System Hold state, Priority Scan and Close Call function are not performed.

The scanner scans only one system while displaying **F** icon by pressing [FUNC] Key. This state is called "Temporary System Hold".

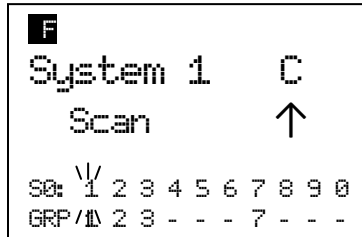

In this state, press [L/O] once to temporarily lock out a current system with “Temporary L/O” message.

Press [L/O] twice within one second to permanently lock out the current system with “Locked out” message.

Long press this key to display the prompt “Unlock All Systems?” for unlocking all systems, sites, search ranges and Close Call Hits system and enable all Quick Keys for all system/site.

Press [E / yes / gps] to unlock all data. Then scanner displays “All Systems” and “Unlocked”.

Press [. / no / pri] to return to the previous mode without unlocking.

In a trunked system, press [Scan / srch] key in Function Mode to change ID Search and ID Scan for the system.

When you select a system while the scanner is Temporary System Hold without a timeout, the scanner scans only the selected system.

If the selected system is locked out, it is automatically unlocks and scans the system. Other lockout states* are not unlocked.

When it cannot scan the selected system, the scanner displays the system name on the first line and “Nothing to Scan” on the second line.

The scanner displays this message until you press any key. Then the scanner exits Temporary System Hold Mode and starts scanning.

**“Other lockout states” means the following. The scanner displays “Nothing to Scan”.

- Quick Key for the selected system is disabled.
- All channel groups for the selected system are locked out.
- Quick key for all channel groups are disabled off.
- All channels for the selected system are locked out.

System Hold

Long press [Hold / 

While on System Hold, the scanner scans only one system and the scanner flashes the HOLD icon.

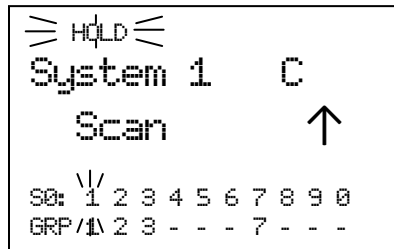

Long press [Hold / 

If the selected system can't be scanned, the scanner can't go to System Hold Mode.

Quick System Select

*In trunked system, the "system" means "site" for this section.

*In Quick System Select state, Priority Scan and Close Call function are not performed.

Turn [Scroll Control] knob in Function Mode to select a System. While selecting systems, scanning is not performed.

You can select from all Systems that have 1 or more Channels. Locked out Systems and Systems belonging to disabled SQKs also appears in this selection.

Press [E / yes / gps] or the [Scroll Control] to select a system and return to the previous mode.

Press [L/O] in Function Mode to toggle lockout state for the selected system.

Press [1 - 9, 0] in Function Mode to enable or disable GQKs for the selected System.

Quick System Select Resume

Pressing [FUNC] or [E / yes / gps] or press the [Scroll Control] resumes scanning immediately from the selected system even if the system is locked out (it is force to be unlocked). The scanner also resumes scanning when a timeout happens.

The temporary system hold status continues after system selection.

If the scanner has no channels to scan (as listed below) in the selected system, it displays "Nothing to Scan".

- SQK for the selected system is disabled.
- All channel groups for the selected system are locked out.
- GQK for all channel groups are disabled.
- All channels for the selected system are locked out.

The scanner resumes scanning from the next system when you press any key.

System Select in Scan Hold Mode

When you go to Quick Select System from Scan Hold Mode and exit from this state, the scanner holds on the first channel of the selected system.

If you select a locked out system, the locked state for the selected system is not changed.

Quick Save for CTCSS/DCS/P25 NAC Data

When CTCSS/DCS search or P25 NAC search is set for a conventional channel and the scanner is detecting a CTCSS/DCS tone data or P25 NAC data, you can store the tone data into the current channel by pressing [E / yes / gps]. The scanner prompts "Set Found CTCSS/DCS?" and "Yes="E" / No=".". "".

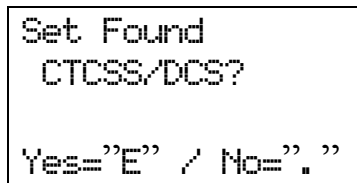

```
Set Found
CTCSS/DCS?

Yes="E" / No="." "
```

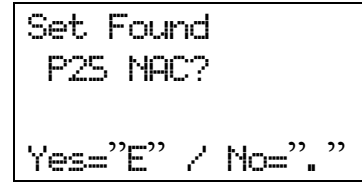

```
Set Found
P25 NAC?

Yes="E" / No="." "
```

Press [E / yes / gps] to store the tone data and go to the editing menu for the current channel.

Press [. / no / pri] to go to the editing menu for the current channel without storing it.

Press [Scan / srch] or [Hold / 

Press [L/O] or [MENU] to cancel the prompt and returns to the previous mode.

Key Operation During Scan

Normal Mode

[Scroll Control] knob

Turn this knob to resume scanning while monitoring.

Turn this knob to change the scan direction. If the scanner is scanning system scan, service search, then custom search turn this knob counterclockwise to scan custom search, service search, then system scan.

[Scan / srch] key

Press this key to resume scanning while monitoring.

[Hold /] key

Press this key to go to Scan Hold Mode.

Long press this key for System Hold Mode.

In System Hold Mode, long press this key for full system scan.

[L/O] key

Press this key once to temporarily lock out the monitored channel or TGID (in ID Search Mode). When the scanner is turned off, the channel or TGID is unlocked.

Press this key twice within one second to lockout the monitored channel or TGID (in ID Search Mode). When the scanner is turned off, these lockouts remain.

Long press this key to unlock all channels and TGIDs in the current system when the scanner is receiving a signal.

[1 - 9, 0] key

Press these keys to enable or disable SQKs.

[. / no / pri] key

Press this key to go to the mode that selects the ten's place for SQKs, then press the number key to jump to the ten's place.

[E / yes / gps] key

Press this key to edit the data for the current channel.

If the current system is a protected system, the scanner displays the "Protected System Access Not Allowed Press Any Key" and sound an error tone.

[MENU] key

Press this key to go to the Menu Mode at Top Menu.

Function Mode

F+[Scroll Control] knob

Turn this knob to select a system quickly. The scanner will start scanning from the selected system.

F+[Scan / srch] key

If the current system is a conventional system or search range:

- Press this key to display the prompt for starting Quick Search.
- Press [E / yes / gps] to start Quick Search.
- Press [. / no / pri] to go to Search for...
- Press [L/O] to cancel the prompt.
- Press [Hold / 

If the current system is a trunked system:

- Press this key to switch between ID Search and ID Scan.

F+[Hold /

Press this key to toggle Close Call functions.

Long press this key to start Close Call Only Mode.

F+[L/O] key

Press this key once to temporarily lock out a system, site, or a search range. When the scanner is turned off, this is unlocked.

Press this key twice in a second to lockout a system, site or a search range. When the scanner is turned off, these lockouts remain.

Long press this key to display the prompt “Unlock All Systems?” to unlock all systems, sites, search ranges and Close Call Hits system and enable all Quick Keys for all systems/sites.

Press [E / yes / gps] to unlock all data.

Press [. / no / pri] to return to the previous mode without unlocking.

F+[1 - 9, 0] key

Press this key to enable or disable GQKs for the current system.

F+[. / no / pri] key

Press this key to toggle Priority Mode for conventional priority.

F+[E / yes / gps] key

Press this key to change to the GPS Mode.

Long press this key to store the current location. Then the scanner prompts you to select the location type.

F+[MENU] key

Press this key to go to the editing menu for the current system or current search range.

If the current system is a protected system, the scanner displays the “Protected System Access Not Allowed Press Any Key” and sounds an error tone.

SCAN HOLD MODE



Press [Hold / 

Display while in Scan Hold Mode

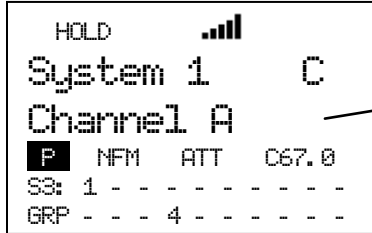
The display in Scan Hold mode is as follows.



This shows a channel name or a frequency.

- C67.0 : This appears when the channel has a CTCSS or DCS. In CTCSS/DCS Search Mode, if this is hit, the value blinks. If CTCSS/DCS is set to lockout, the display alternates between the CTCSS/DCS data and "*****". In P25 NAC Search Mode, if a P25 NAC code is found, it will also be displayed in this area.
- HOLD : This icon appears while in Scan Hold Mode.
-  : This icon shows the strength of the signal from 0 to 5.
-  : This icon appears if the channel is set to "Priority On".
- NFM : These icons show the modulation type.
- ATT : This icon appears when the channel is set to "Attenuator On".
- SQ: : This icon appears with icons of the SQK (from "0" to "99"). x shows the current ten's place for the SQK.
- GRP : This icon appears with icons of the GQK (1 - 9,0).

General Operation

Turn [Scroll Control] to select the channel, trunk frequency, TGID or search frequency.

Hold on a Channel in Conventional System:

The scanner alternately displays the system and channel group name on the first line and it displays the channel on the second line. The SQK and GQK for the channel is displayed. The scanner continuously monitors the selected channel.

While holding on a channel, the scanner changes the display for the system name and channel group name every second.

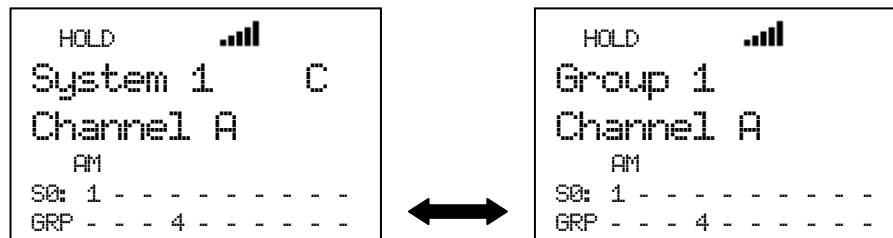

Press [E / yes / gps] to go to the editing menu of channel you are holding on at Channel Settings.

Press [FUNC] to go to the Function Mode and display the system number tag, channel number tag, IF Exchange and Volume level.

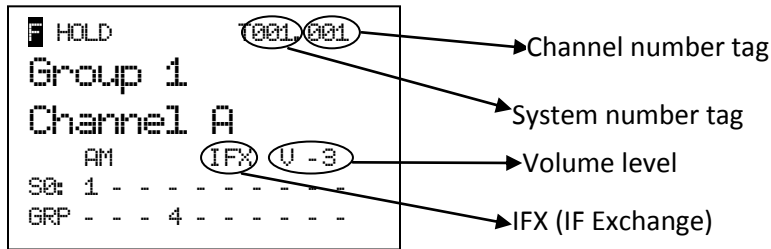

Press [6 / RIGHT / disp] in Function Mode to change the Display Mode.

The scanner displays the channel name on the second line.

In Display Mode 2, the scanner displays the current channel frequency under the channel name instead of the priority channel icon, modulation icon, and attenuator.

In Display Mode 3, since the scanner can't display the Trunking Activity Indicators for a conventional system, it displays just like Mode 1 for conventional.

For example, the scanner displays as follows when the channel name for "162.4000MHz" is "Channel A".

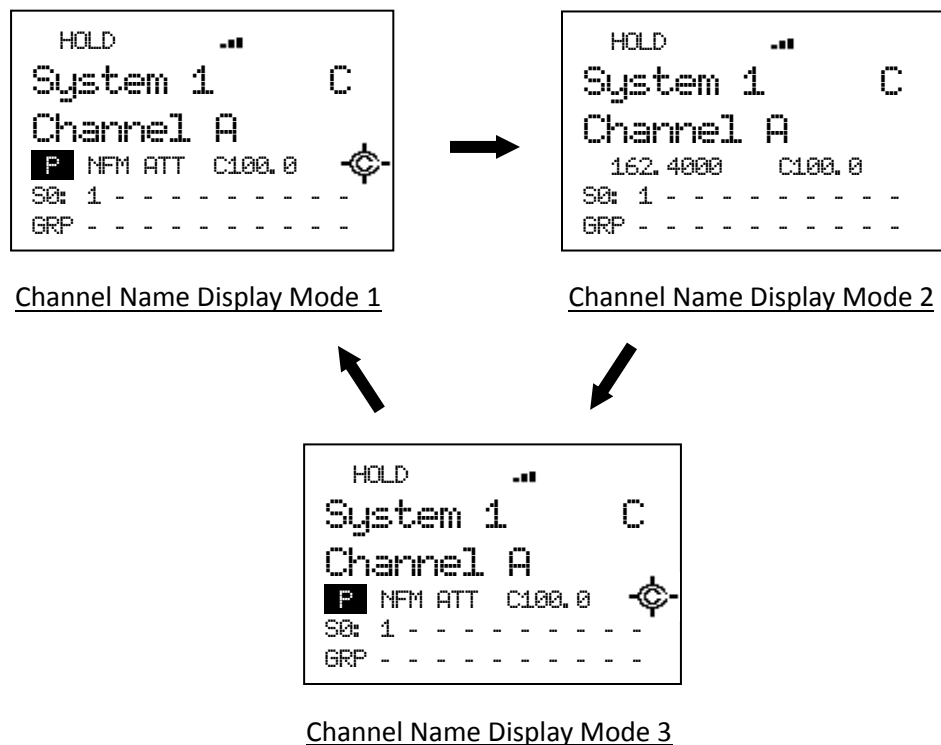

In Display Mode 2 and 3, even if the Close Call setting is "CC Pri" or "CC DND", the Close Call icon is not displayed when CTCSS/DCS setting is set or tone data has been detected in CTCSS/DCS Search mode.

Hold on a Channel (TGID) in Trunked System:

*If there are two or more sites in the system, the same TGIDs will appear in every site. The scanner checks the current site for the selected TGID.

When you hold on a channel in a trunked system and a C-Ch exists, the scanner displays as follows.

If the TGID you are holding on is stored into the system, first line alternately displays the site name and channel group name. The second line displays the TGID Name. The V-Ch frequency is displayed under the TGID display.

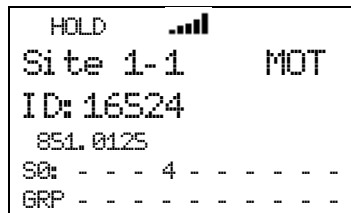

Press [6 / RIGHT / disp] in Function Mode to change the Display Mode.

In Display Mode 1, the scanner displays the TGID name on the second line and the V-Ch frequency under the second line.

In Display mode 2, the scanner displays the TGID name on the second line and TGID under the second line.

In Display mode 3, the scanner displays the TGID name on the second line and trunking activity indicators under the second line.

For example, the V-ch frequency is “851.0250MHz” and the channel name of “ID:16512” is "Police".

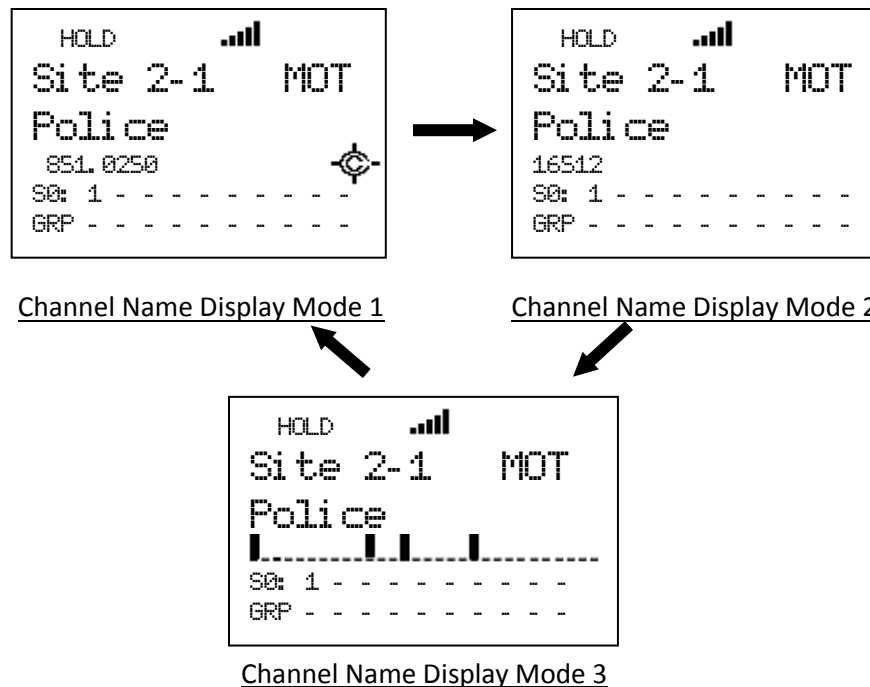

In Channel Name Display Mode 2 and 3, even if the Close Call setting is “CC Pri” or “CC DND”, the Close Call icon is not displayed.

For example, "ID:0-01-063" for the LTR System displays in Channel Name Display Mode 2.

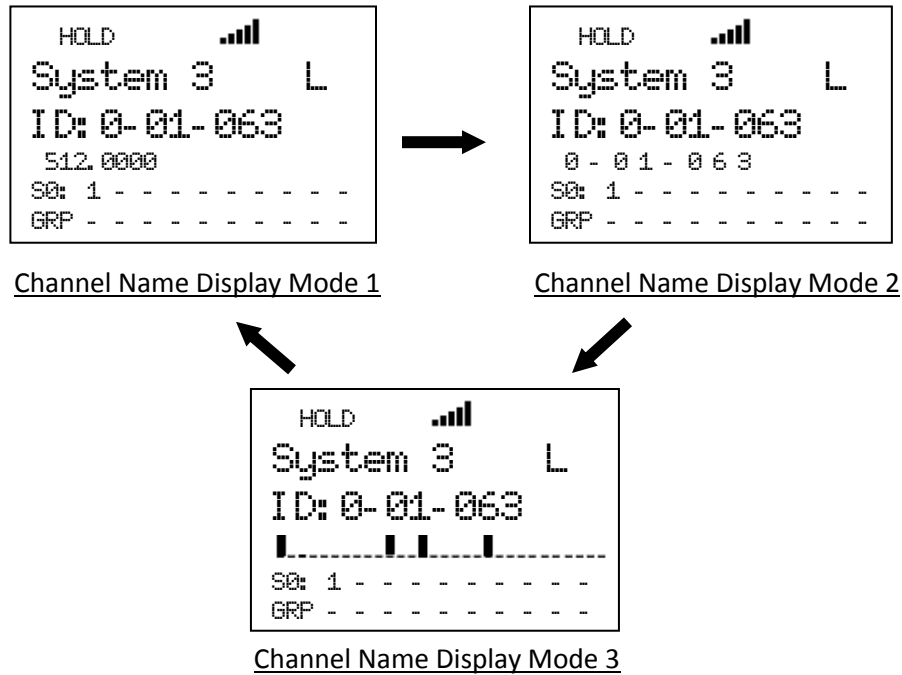

Hold on System Frequency:

The scanner displays the system name and System ID on the first line. It displays the trunk frequency on the second line.

For example, if 935.0125 MHz in "Site 3-1 MOT" belonging to Quick Key 1 is selected, the scanner displays:

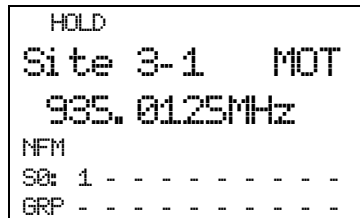

Press [E / yes / gps] to go to the System Editing menu at System Settings.

When the scanner receives a TGID, it displays the received TGID on the second line. If the TGID is already stored into the system and it is named, the channel name is displayed instead of the TGID. The holding trunked frequency is displayed under the TGID display.

In a P25 System, pressing [FUNC] key causes the scanner to display the WACN (Wide Area Communications Network) ID instead of System ID on first line.

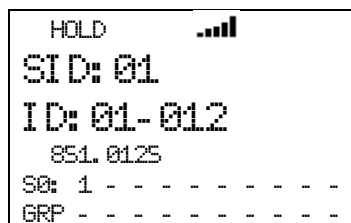

*In Motorola System, System ID is displayed as "SID:xxxxh-yyzz".

"xxxxh" means System ID. "yy" means Sub System ID. This is always is 00 for Motorola analog systems. "zz" means SITE ID.

*WACN ID is displayed as "WACN:xxxxx".

For a system other than an EDACS SCAT System, the scanner monitors the received signal on the C-Ch or V-Ch.

*For EDACS SCAT Systems, the scanner only monitors Voice Data. It always the displays system name on the first line and the trunk frequency on the second line.

Hold on Search Frequency:

The scanner displays the Search Range Name on the first line and the held frequency on the second line.



Press [E / yes / gps] to go to Quick Save Mode.

Hold on Conventional System

Turn [Scroll Control] clockwise to select the next channel.

Turn [Scroll Control] counterclockwise to select the previous channel.

If you turn [Scroll Control] clockwise when the scanner is on the last channel in the system, the scanner goes to the next system. If you turn [Scroll Control] counterclockwise when the scanner is on the first channel in the system, it goes to the previous system.

Hold on Trunked System

Turn [Scroll Control] to select the site frequency and channel (TGID).

Turn [Scroll Control] clockwise to select the next system frequency or channel and turn [Scroll Control] counterclockwise to select previous one.

If you turn [Scroll Control] clockwise when the scanner is on the last site frequency, it goes to the first channel in the System. If you turn [Scroll Control] clockwise when the scanner is on the last channel, it goes to the next system or site.

Turning [Scroll Control] counterclockwise on the first channel goes to the last site frequency. And turning [Scroll Control] counterclockwise on the first site frequency goes to the previous system or site.

When the scanner holds on a site frequency, the scanner displays the received TGID. It does not go to any voice channel. And you cannot lock out the displayed TGID.

Hold on TalkGroup ID from ID Search / ID Scan

The scanner monitors the held TGID continuously.

While monitoring a TGID already stored into Memory, the first line displays alternates between the current site name and the current group name, and the second line displays the current channel name. Also, the SQK and GGK numbers for the current monitoring site and channel group appears.

While monitoring an TGID not stored into Memory, the first line displays the current site name and the second line displays the monitored TGID. Also the SQK number for current Site appears.

Press [Scan / srch] or [Hold / 

Direct Entry

*The scanner receives nothing in this mode.

You can quickly store a frequency or a TGID using [0 - 9] and [. / no / pri].

You can also direct access channels that have channel number tags assigned.

Store Frequency

*You cannot use this function to store a frequency for a trunked System.

To quickly store a frequency into a channel for a conventional system, enter the frequency including the decimal point using the keypad, then press [E / yes / gps]. The scanner prompts "Quick Freq Save?".

*If you press [Hold / Go to Quick Search Hold Directly)



```
Quick Freq Save?  
25.0000MHz
```

If you press [E / yes / gps], the scanner creates a system named "Qck Save Cnv Sys" and creates a group named "Qck Save Grp" in the System. The scanner stores the entered frequency. If the scanner already the system and the group, the frequency is stored into the group.

If you press [. / no / pri], you can select a conventional system and the channel group for the frequency. The scanner displays only conventional systems that already exists. Next, the scanner displays channel groups and lets you select the channel group to store the entered frequency into.

Store TGID

To quickly store a TGID into a channel, enter the TGID using the number and decimal keys. Press the decimal key twice to enter a hyphen. If you press the decimal key first or at the left end, it will be entered as "i" for I-Call ID. Then press [E / yes / gps] and the scanner prompts "Quick TGID Save?".



Quick TGID Save?
4128

If you press [Hold / 

If you press [E / yes / gps], the scanner creates "Qck Save Grp" in the current system and stores this TGID there.

If you press [. / no / pri], the scanner prompts you to select a system to store this TGID.

Select the system* and the channel group, then the TGID is stored.

*In system selection, the scanner displays only the systems whose TGID format matches the TGID you entered. The ID format and system type relation are the following.

Input TGID (n: number)	System Type
nnn-nn nnnn-n n- nnn- nnnn- nnn-n nnnnn innnnn	Motorola Systems (Type I, Type II)
nnnnn innnnnnnn	P25 Systems
nn-nnn nn- nn-nn- innnnn	EDACS Systems *Only AFS Format is allowed for Direct Entry except for I-Call ID.
n-nn-nnn n-nn-	LTR Systems

*For details of TGIDs, please see: [TGID FORMAT FOR TRUNKED SYSTEM.](#)

Once saved, the scanner allows you to change the Channel settings at menu location [Channel Settings.](#) Press [HOLD / 

Direct Access

Use this feature to quickly access a channel with number tags. System or channel number tags can be set in the menu. However if you set a channel number tag that already exists in the same system, or if you set a system tag that already exists in another system (include scan systems, service search with scan systems, custom search with scan systems, CC Hits with scan systems), a warning message will be displayed “No.Tag Exists Accept? (Y/N)”. Press [E / yes / gps] to set the same number tag, or press [./ no / pri] to input a new number tag.

To jump to a tagged channel from HOLD mode, enter the system number tag followed by a decimal point then the channel’s number tag, then press [MENU]. The scanner goes to Scan Hold Mode at the entered number tag.

For example, if you want to select Channel E from the below example, press [7][.][5][Menu].

System A (Number tag = 1)	Channel A (Number tag = 1)
	Channel B (Number tag = 5)
	Channel C (Number tag = 100)

System B (Number tag = 7)	Channel D (Number tag = 10)
	Channel E (Number tag = 5)
	Channel F (Number tag = 3)

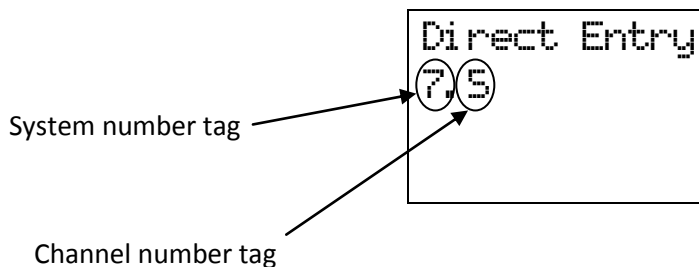

You do not have to enter the system number tag to select a channel in the current system.

When the scanner is holding on one of System A’s channels, press [1][0][0][Menu] to select Channel C.

If you press only system number tag with a dot, the scanner select the first channel of the system. Pressing [7][.][Menu], Channel D is selected. If no such system number tag exists, the scanner displays “SYS Number Tag XXX. is not Stored Press Any Key” and sounds an error tone.

If you enter an illegal channel number tag, the scanner displays “CH Number Tag XXX.XXX is not Stored Press Any Key” and sounds an error tone.

Key Operation During Scan Hold Mode

Normal Mode

[Scroll Control] knob

Turn this knob to select the channel.

[Scan / srch] key

Press this key to resume scanning.

[Hold /] key

Press this key to resume scanning.

Long press this key to activate System Hold Mode and resume scanning.

[L/O] key

Press this key once to temporarily lock out the held frequency or TGID. When the scanner is turned off, this is unlocked.

Press this key twice in a second to lock out the held frequency or TGID. When the scanner is turned off, this remains locked.

Long press this key to unlock all channels in the current system (for conventional systems).

Long press this key to unlock all frequencies of the site and all TGIDs of the current system (for trunked system / sites).

[1 - 9, 0] key

Press this key to enter numbers and go to Direct Entry.

[. / no / pri] key

Press this key to input decimal point, hyphen or “i” for Direct Entry.

[E / yes / gps] key

Press this key to edit the data for the current channel.

Press this key to edit the system when the scanner is held on a trunked frequency.

If the current system is protected system, the scanner displays “Protected System Access Not Allowed Press Any Key” and sound an error tone.

[MENU] key

Press this key to go to the Menu Mode at Top Menu.

Press this key to use Direct Access in Direct entry mode.

[FUNC] key

Press this key to go to Function Mode with a 3-second timeout. The scanner displays the system number tag and channel number tag. If you do not press a key within 3 seconds, function mode is automatically cancelled.

Long press this key to go to Function Mode without a timeout.

For P25 Systems, pressing [FUNC] causes the scanner to display the WACN ID instead of the System ID on the first line.

Function Mode



[Scroll Control] knob

Turn this knob to quickly select a system.

[Scan / srch] key

Press this key to display the prompt for starting Quick Search.

If the current system is a conventional system or search range:

- Press [E / yes / gps] to start Quick Search.
- Press [. / no / pri] to go to Search for...
- Press [L/O] to cancel this prompt.
- Press [Hold / - If the current system is a trunked system:
 - Press [E / yes / gps] to start ID Search.
 - Press [. / no / pri] to go to Search for...
 - Press [L/O] to cancel this prompt.
 - Press [Hold / 

[Hold /

Press this key to toggle Close Call functions.

Long press this key to start Close Call Only Mode.

[L/O] key

Press this key once to temporarily lock out a system or a search range. When the scanner is turned off, this is unlocked.

Press this key twice in a second to lockout a system or a search range. When the scanner is turned off, this remains locked out.

Long press this key to turn on all Quick Key settings for systems / Sites, and unlock all systems and search ranges.

Long press this key to display the prompt “Unlock All Systems?” for unlocking all systems, sites, search ranges and Close Call Hits system and enable all Quick Keys for all system/sites.

Press [E / yes / gps] to unlock all data.

Press [. / no / pri] to return to the previous mode without unlocking.

[1-3 / sr1-3] key

Press this key to start searching the search range set at Set Search Key.

[4 / LEFT / ifx] key

Press this key to exchange the IF(intermediate frequency) for receiving radio signals to avoid interference.

[5 / lvl] key

Press this key to change the volume offset level.

[6 / RIGHT / disp] key

Press this key to change the Display Mode.

(Display mode 1 -> Display mode 2 -> Display mode 3 -> Display mode 1 ->....)

[7 / att] key

Press this key to toggle the attenuator setting.

Long press this key to toggle the global attenuator setting.

[8 / rev] key

Long press this key to show the reverse frequency for the current frequency.

And release this key to return to the current frequency.

[9 / mod] key

Press this key to toggle the modulation state for global setting.

[0 / wx] key

Press this key to change WX Alert Priority Mode.

Long press this key to start WX Scan.

[. / no / pri] key

Press this key to toggle Priority Mode for conventional priority.

[E / yes / gps] key

Press this key to change to the GPS Mode.

[MENU] key

Press this key to go to the editing menu for the current system or current search range.

If the current system is a protected system, the scanner displays "Protected System Access Not Allowed Press Any Key" and sound an error tone.

PRIORITY SCAN

There are two kinds of Priority Scan. (See: [Set Priority](#))

Refer to [Set Priority](#) for setting Priority Channels.

Priority Scan

This works in Scan Mode or Scan Hold Mode when the Priority Scan setting is on. In this condition, "PRI" icon appears.

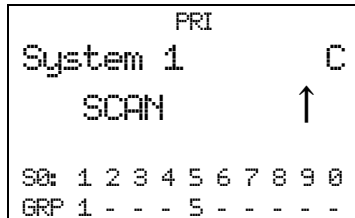

When the scanner is scanning a conventional system, it interrupts every 2 seconds to check Priority Channels (P-Ch) of all unlocked conventional Systems for activity. If there are many P-Chs, Priority Scan interrupts normal scanning for a long time.

Although any conventional frequency can be set as a priority channel, the scanner is unable to scan over 100 channels at once. If there are more than 100 unlocked priority channels, the first 100 channels will be scanned for priority scanning but others won't.

The priority for P-Channels is determined by System and Group Quick Key settings.

The highest priority is for P-Channels to which the SQK and GQK are "1". And the lowest priority is for P-Channels to which the SQK is "90" and GQK is "0".

Priority for P-Channels in the same channel group follows the order in which the channels were created.

If there are no Priority Channels or all Priority Channels are locked out, the scanner displays "Priority Scan No Channel" and sounds an Error Tone. The scanner cannot work the Priority Scan. The scanner restarts normal scanning when you press any key. Priority Scan is set to off automatically.

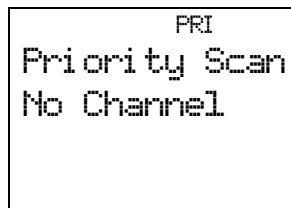

Priority Plus Scan

This works in Scan Mode or Scan Hold Mode when the setting of Priority Scan is Plus On. In this condition, the "PRI" icon blinks and the scanner scans only Priority Channels.

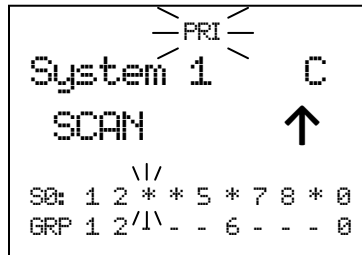

If there is no Priority Channel or all Priority Channels are locked out, the scanner displays "Priority Scan No Channel" and sounds an Error Tone. Then Priority Plus Scan stops.

Press any key to cancel it. Priority Scan is turned off automatically and it starts normal scanning.

Key Operation During Priority Scan

Key operations are the same as in Scan Mode and Scan Hold Mode.

See: [Key Operation During Scan](#) and [Key Operation During Scan Hold Mode](#).

PRIORITY ID SCAN

Refer to [Set Priority](#) to set Priority Channels. Refer to [Priority ID Scan](#) for activation of Priority ID Scan.

Priority ID Scan

Priority ID Scan works in ID Scan/Search Mode or ID Scan/Search Hold Mode when the Priority ID Scan setting is on.

This works on Motorola and EDACS (Wide, Narrow), LTR, and P25 Standard systems.

This function is very similar to conventional priority although there is no “interrupt” during the transmission. Priorities are checked in between transmissions, when the scanner is receiving the control channel, as during the channel delay period.

Motorola system can receive priority IDs while the scanner is on the voice channel. However, for this to work, the channel must also be assigned as a priority channel by the radio system (otherwise, the TGID will never be sent on the voice channel’s low-speed data).

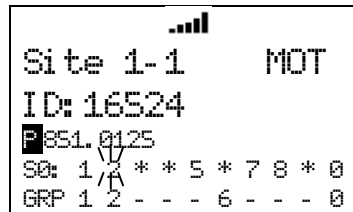

The scanner can only look for priority channels on the trunked system it is currently scanning and only responds if the priority channel is unlocked..

The within the system, channels in channel groups with GQK 1 are treated with highest priority, followed by 2, 3, ... 9, 0.

Key Operation During Priority ID Scan

Key operations are same as in ID Scan Mode and ID Scan Hold Mode.

See: [Key Operation During Scan](#) and [Key Operation During Scan Hold Mode](#).

SEARCH MODE

The scanner has Service Search, Custom Search and Quick Search in Search Mode.

Display during Search Mode

The LCD display in Search mode is as follows.

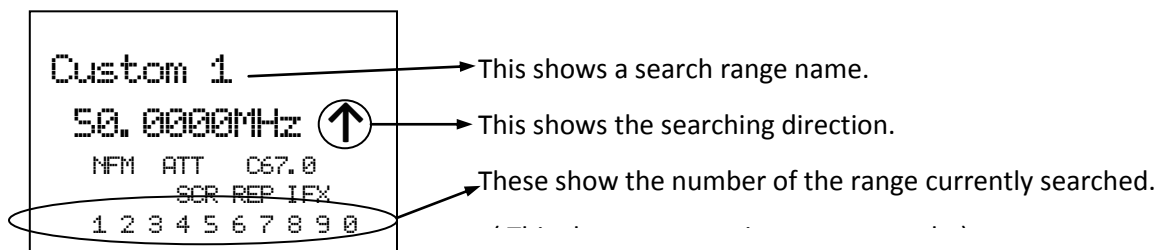

- NFM : These icons show the modulation type.
- ATT : This icon appears when the attenuator for a range or global attenuator is On.
- C67.0 : The scanner displays the data of CTCSS/DCS in the location here.
- SCR : This icon appears when one or more Broadcast Screen is set to On.
- REP : This icon appears when the Repeater Find function is On.
- IFX : This icon appears on frequency that have IF exchange On.

General Operation

While searching, frequencies are displayed in order, and the searching direction is also displayed on right end.

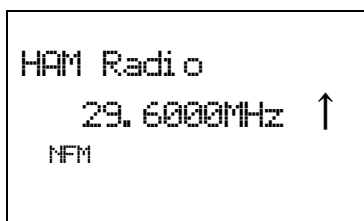

While searching, locked out frequencies are skipped. The lockout information is common to all Searches and Close Call. You can confirm or unlock these locked out frequencies at [Freq Lockouts](#).

Press [Hold / 

If CTCSS/DCS Search is On (See: [Tone/Code Search](#)), the scanner searches for any active CTCSS/DCS on the frequency. (Not for the AM, FMB and WFM modulation.)

For example, if it stops on 152.8700MHz in News and finds CTCSS is 67.0 Hz, the scanner displays as follows.

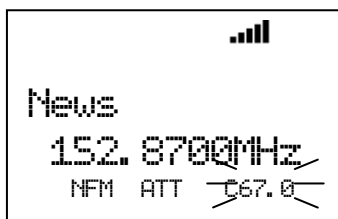

If the scanner finds DCS 023, the scanner would display “DCS023” instead of “C67.0”.

Service Search

You can search one of the pre-programmed search ranges.

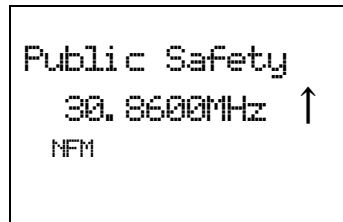

The Scanner starts from the lowest frequency of the selected range and searches in ascending or descending order. While searching, turn [Scroll Control] to change the searching direction.

If the scanner finds a transmission, it stops on the frequency and the second line displays the frequency and the unit "MHz". The scanner displays a signal meter that shows a signal level. (1 – 5)

For example, if it stops on 30.9000 MHz in Public Safety, the scanner displays as follows.



If the search range is one that includes channel numbers (like CB or Marine), the scanner displays the frequency and the channel number. The frequency unit is not displayed.

For example, if it stops on 27.4050 MHz of CB Radio, the scanner displays as follows.

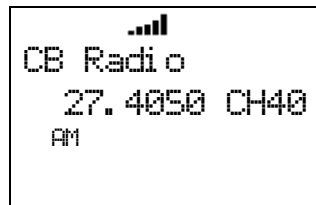

While monitoring the transmission, press [SCAN / srch] in Function Mode or turn [Scroll Control] to resume searching.

Press [L/O] once to temporarily lock out the frequency. The scanner displays "Temporary L/O".

Press [L/O] twice in a second to permanently lock out the frequency. The scanner displays "Locked Out", then resumes searching from the next frequency.

*If you lock out all frequencies in the selected range, the scanner displays "All Locked!" on the second line and searching does not work.

Custom Search

Custom search can start by selecting Custom Search.

When performing a custom search, you can turn on or off custom ranges by pressing the [0 - 9] keys. You cannot turn off the last Custom Range. If you try, the scanner sounds an Error Tone. The scanner only searches turned on custom ranges. The current search range number blinks.

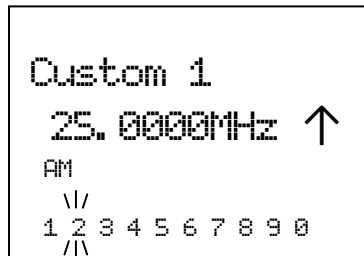

The scanner starts searching from the lowest frequency of the first turned on range and proceeds in ascending order. Or, it starts from the highest frequency of the last turned on range and searches in descending order. While searching, turn [Scroll Control] to change the search direction.

If the scanner finds a transmission, it stops on the frequency and the second line displays the frequency.

While monitoring the transmission, press [SCAN / srch] in Function Mode or turn [Scroll Control] to resume searching.

Press [L/O] once to temporarily lock out the frequency. The scanner displays "Temporary L/O".

Press [L/O] twice in a second to lock out the frequency permanently. The scanner displays "Locked Out", then resumes searching from the next frequency.

If you turn off the current search range number, the scanner searches from the next range.

The scanner stays on a frequency until the delay time expires after a transmission ends.

When you start a Custom Search by selecting "Custom Search" from the Menu, the frequency is initialized and the scanner starts searching. When searching in ascending order, the scanner searches from the lowest frequency of the lowest-numbered turned on Range. When searching in descending order, the scanner searches from highest frequency of the highest-numbered turned on Range.

When the scanner returns to Custom Search by canceling Menu Mode, it resumes searching from the previous frequency in the previous direction. However, if the limit settings of one of Custom Ranges are changed and the previous frequency becomes out of limit, it searches from the lowest frequency of the previous Range for ascending order or from highest frequency of the previous Range for descending order.

Custom Search Temporary Hold :

The scanner searches only the selected range while in Function Mode. When the scanner returns to Normal Mode, it resumes searching all enabled ranges.

Custom Search Range Select :

You can select the range by turning [Scroll Control] in Function Mode. When the scanner returns to Normal Mode, it searches from the selected range.

If you select a range that is turned off, the scanner turns on the range and starts searching from the range.

Custom Search in Control Channel Only Mode

This is valid only for Custom ranges that have the C-CH Only setting turned on at Set C-Ch Only. And this function tracks Motorola and LTR.

The scanner searches only for control channels. If a received transmission is not a control channel, searching resumes immediately.

Receive Motorola Control Channel:

The scanner starts trunking. Acquired TGIDs are displayed. The first line displays the system name and system ID name/ID in turn. The second line displays the TGID. The C-Ch frequency is displayed in the line under the TGID display.

If you have set the correct band plan for the received control channel at Set MOT BandPlan, the scanner will automatically track voice calls on the system.

The scanner toggles the following display while receiving signals.

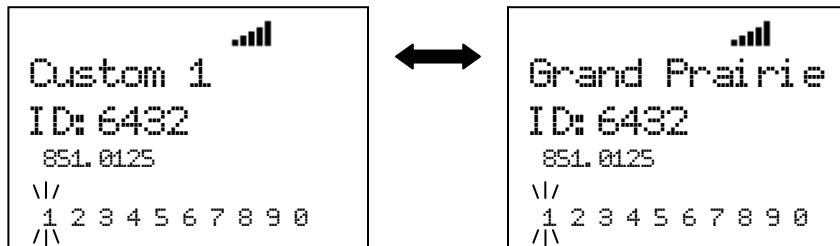

Scanner displays system name.

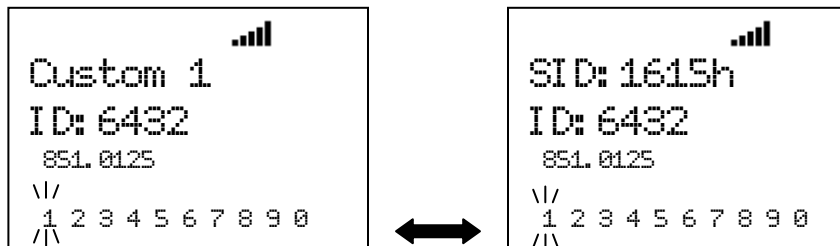

Scanner displays system ID.

If no ID exists, it displays "ID: -----".

Receive LTR Control Channel:

The scanner displays "LT System" and TGID. The scanner toggles the following display while receiving it.

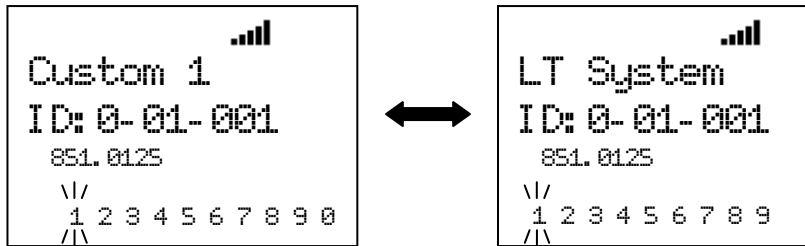

Key Operation :

Turn [Scroll Control] to resume Frequency Search.

When receiving a Motorola control channel, press [6 / RIGHT / disp] key in Function Mode to change the system ID name display (Display Mode 1,3) and system ID display (Display Mode 2). This doesn't work in Scan Mode, because this is used for Group Quick Key operation.

Search and Store

The scanner searches and stores found frequencies or TGIDs automatically. You can make the scanner perform this function by menu selection. See Search and Store for details.

In this operation, the setting of Set C-Ch Only is invalid.

Quick Search

Quick Search searches all bands.

You can start Quick Search by pressing [SCAN / srch] key in Function Mode during Scan Mode, Scan Hold Mode, Close Call Mode, Weather Scan Mode and Tone-Out Mode. The scanner prompts "Quick Search?".

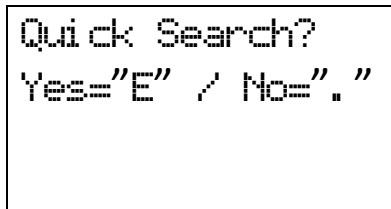

If you press [E / yes / gps], the scanner starts Quick Search.

If you press [./ no / pri], the scanner goes to the Search for... Menu at Search for...

If you press [Hold / , the scanner goes directly to Quick Search Hold Mode.

Pressing [L/O] cancels the prompt and it returns to previous mode.

Quick Search for frequency

The scanner searches from the current channel frequency when the Quick Search starts from monitoring / holding in conventional systems, Close Call Mode, Weather Scan Mode and Tone-Out Mode.

The range of this searching is all ranges of the scanner.

Turn [Scroll Control] to change the searching direction.

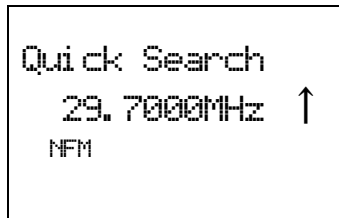

If the scanner finds a transmission, it stops on the frequency and the second line displays the frequency.

While monitoring the frequency, press [SCAN / srch] in Function Mode or turn [Scroll Control] to resume searching.

Press [L/O] once to lock out the frequency temporarily. The scanner displays "Temporary L/O".

Press [L/O] twice in a second to lock out the frequency permanently. The scanner displays "Locked Out", then resumes searching from the next frequency.

Quick Search for TalkGroup ID

When the scanner is on a trunked system in Scan Hold Mode, the scanner performs ID Search operation on the current System. The setting of ID Scan/Search is ID Search. See [Scan for Trunked Systems](#).

Key Operation During Search Mode

Normal Mode

[Scroll Control] knob

Turn this knob to change the searching direction.

While monitoring a frequency, turn this knob to resume searching.

[SCAN / srch] key

Press this key to go to Scan Mode.

[Hold /] key

Press this key to go to Search Hold Mode.

[L/O] key

Press this key to temporarily lock out the current frequency. When the scanner is turned off, the frequency is unlocked.

Press this key twice in a second to permanently lock out the current frequency. When the scanner is turned off, the frequency remains locked.

Long press this key to unlock all frequencies that are locked out in Search Mode and Close Call Mode.

[1 - 9, 0] key

Press this key to turn on or off each custom search range. However, this key operates only in Custom Search and does not operate in other searches.

[E / yes / gps] key

Press this key to quickly store the current frequency.

[MENU] key

Press this key to go to the Menu Mode at Top Menu.

Function Mode

[Scroll Control] knob

Turn this knob to select a custom search range. The scanner restarts searching from the selected search range. This knob operates only in Custom Search and does not operate in other searches.

[SCAN / srch] key

Press this key to resume searching while monitoring a frequency.

[Hold /] key

Press this key to toggle Close Call functions.

Long press this key to start Close Call Only Mode.

[L/O] key

Press this key to go to Rvw Search L/O.

[1 - 3 / sr 1 - 3] key

Press this key to start searching the search range set at Set Search Key.

[4 / LEFT / ifx] Key

While monitoring a frequency, press this key to exchange IF(intermediate frequency).

[6 / RIGHT / disp] Key

Press this key to change the system ID display and system ID name display in custome search if C-Ch Only Mode is on.

[7 / att] key

Press this key to toggle the attenuator state for the search range.

Long press this key to toggle global attenuator.

[8 / rev] key

Long press this key to show the reverse frequency for the current frequency.

And release this key to return to the current frequency.

[9 / mod] Key

Press this key to change the modulation.

[0 / WX] key

Press this key to change WX Alert Priority Mode.

Long press this key to start WX Scan.

[E / yes / gps] key

Press this key to change to the GPS Mode.

[MENU] key

Press this key to go to Search for... in Service Search and Custom Search.

Press this key to go to Srch/CloCall Opt in Quick Search.

SEARCH HOLD MODE

Press [Hold / 

General Operation

The scanner monitors the frequency continuously. The scanner displays the search range name on the first line. In Quick Search, it displays "Quick Search" on the first line. The scanner displays the monitored frequency on the second line.

Turn [Scroll Control] to select the frequency.

Press [L/O] once to temporarily lock out the frequency. The scanner displays "Temporary L/O".

Press [L/O] twice in a second to permanently lock out the frequency. The scanner displays "Locked Out".

Press [L/O] on a locked out frequency to unlock it. The scanner displays "Unlocked".

Long press [L/O] to unlock all frequencies in the current search range. The scanner displays "Srch Lockouts" and "All Unlocked".

Press [SCAN / srch] in Function Mode or [Hold / 

Custom Search Range Select :

Turn [Scroll Control] knob in Function Mode to select the Custom Search Range. Once the Range is changed, the monitoring frequency is set to upper limit frequency or lower limit frequency depends on searching direction. If the direction is ascending order, the frequency is set to lower limit frequency of selected Range. Otherwise, if that is descending order, the frequency is set to upper limit frequency.

Press [Scroll Control] knob again or [SCAN / srch] key to start searching.

Go to Quick Search Hold Directly

When the scanner stops on a received signal or holds on in any Hold Mode, the user can go to Quick Search Hold Mode directly.

Enter a frequency using [0-9] and [./no/pri] then press [Hold / 

Direct Entry

Enter the frequency or TGID by using the number and decimal keys, then press [E / yes / gps] key to quickly store a channel. (See: Direct Entry for details.)

Quick Save

Press [E / yes / gps] without entering data to quickly store the held frequency.

This Quick Save function is almost the same as Direct Entry.

(See: Direct Entry for details.)

The name of the stored frequency is the frequency when the scanner is not receiving location data from a GPS unit.

If you store the detected frequency while receiving location data from a GPS unit, the channel name of the stored frequency becomes the current Latitude/Longitude data.

The channel name format depends on the format set in Set Pos Format.

“DMS:DDD°MM’S.SS” is set

If the latitude data is “32°57’33.60 N” and the longitude data is “97°05’34.18 W”, the channel name becomes “3257.33-09705.34”.

“DEG:DD.dddddd” is set

If the latitude data is “32.959333 N” and the longitude data is “097.092827 W”, the channel name becomes “32.9593-097.0928”.

Key Operation During Search Hold Mode

Normal Mode

[Scroll Control] knob

Turn this knob to change the searching direction.

While monitoring a frequency, turn this knob to resume searching.

[SCAN / srch] key

Press this key to go to Scan Mode.

[Hold /] key

Press this key to resume searching.

[L/O] key

Press this key to temporarily lock out the current frequency. When the scanner is turned off, the frequency is unlocked.

Press this key twice in a second to permanently lock out the current frequency. When the scanner is turned off, the frequency stays locked.

Long press this key to unlock all frequencies that are locked out in Search Mode and Close Call Mode.

[1 - 9, 0] key

Press this key to enter numbers and go to Direct Entry.

[. / no / pri] key

Press this key to input decimal point, hyphen or “i” for Direct Entry.

[E / yes / gps] key

Press this key to quickly store the current frequency.

[MENU] key

Press this key to go to the Menu Mode at Top Menu.

Function Mode

[Scroll Control] knob

Turn this knob to select a custom search range. The monitored frequency is set to the upper limit frequency or lower limit frequency, depending on the search direction.

This knob operates only in Custom Search and does not operate in other searches.

[SCAN / srch] key

Press this key to resume searching while monitoring a frequency.

[Hold /] key

Press this key to toggle Close Call functions.

Long press this key to start Close Call Only Mode.

[L/O] key

Press this key to go to Rvw Search L/O.

[1 - 3 / sr 1 - 3] key

Press this key to start searching the search range set at Set Search Key.

[4 / LEFT / ifx] Key

Press this key to exchange IF(intermediate frequency) for the current frequency.

[6 / RIGHT / disp] Key

Press this key to change the system ID display and system ID name display if C-Ch Only Mode is on.

[7 / att] key

Press this key to toggle the attenuator state for the search range.

Long press this key to toggle global attenuator.

[8 / rev] key

Long press this key to show the reverse frequency for the current frequency.

And release this key to return to the current frequency.

[9 / mod] Key

Press this key to change the modulation.

[0 / WX] key

Press this key to change WX Alert Priority Mode.

Long press this key to start WX Scan.

[E / yes / gps] key

Press this key to change to the GPS Mode.

[MENU] key

*Press this key to go to Search for... in Service Search and Custom Search.

Press this key to go to Srch/CloCall Opt in Quick Search.

CLOSE CALL MODE

The basic Close Call feature allows the scanner to immediately lock onto a transmission above a threshold signal strength. The way the scanner treats a Close Call is based on settings of the menu at Srch/CloCall Opt and Close Call.

Display during Close Call Mode

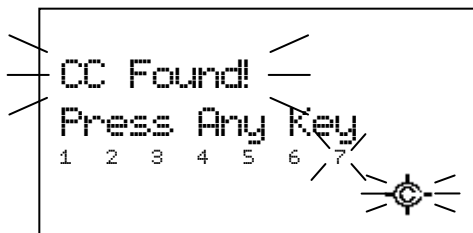

: This icon indicates when the Close Call Mode is "CC Pri".

: This icon indicates when the Close Call Mode is "CC DND".

Close Call Search

*Close Call function does not work in Temporary Hold or System Select of Scan Mode, Weather Scan Mode, Search and Store Mode and Tone-Out Mode.

**While the scanner is staying on a repeater frequency or a reverse frequency, it does not prompt for any new Close Call hits.

The scanner checks Close Call transmissions while scanning or searching every 2 seconds.

If a Close Call hit is found, the scanner alerts the user according to the setting of Set CC Alert, and the Close Call icon blinks.

CC DND is set:

The scanner does not make Close Call checks when it is already receiving a voice transmission.

"DND" means "Do Not Disturb".

CC Pri is set:

The scanner makes Close Call checks even if it is receiving a voice transmission.

You will notice a "gap" every two seconds when receiving a voice transmission.

CC Override is On:

When the scanner gets a Close Call hit, it displays as follows.

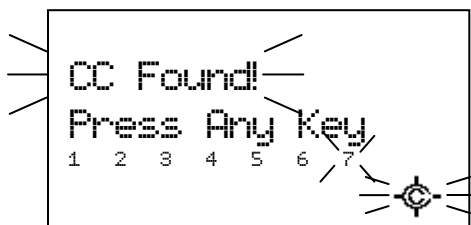

Press any key other than [Hold / ] to listen the detected frequency.

Press [Hold / 

If the scanner gets a Close Call hit in GPS Mode, it displays “Press FUNC Key” on the 4th line.

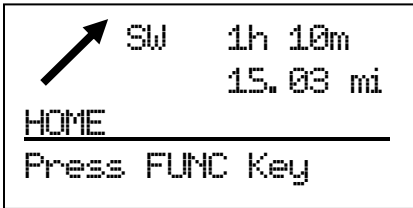

You can listen to the detected frequency by pressing [FUNC] or [Hold / 

CC Override is Off:

When the scanner gets a Close Call hit, it displays as follows.

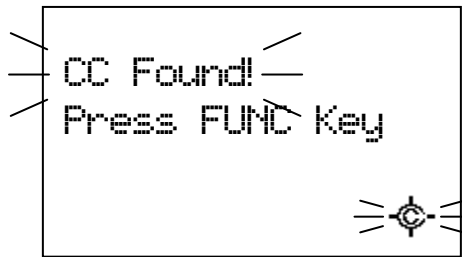

Press [FUNC] or [E / yes / gps] to listen to the detected frequency.

Press [. / no / pri] or don't press any key during the time that is set in Set CC Pause to ignore the Close Call hit and return to the previous state. In this state, pressing [Scroll Control], [L/O] or [Menu] operates the same as pressing [. / no / pri], and other keys are invalid.

If you ignored the hit during the CC Pause time, the scanner will not check for any Close Call transmission for 10 seconds.

Press [Hold / 

When the scanner gets a Close Call hit in GPS Mode, it displays “Press FUNC Key” on the 4th line and you can press [FUNC] or [Hold / 

Monitoring Close Call Transmission:

While monitoring a Close Call transmission, the scanner displays "Close Call" on the first line and the frequency on the second line. The modulation is displayed and the Close Call icon blinks.

If Attenuation, Broadcast Screen or Repeater Find for Srch/CloCall Opt are on, each icon is displayed.

For example, if the scanner finds a transmission on 462.7125 MHz, it displays as follows.



In this condition, the scanner does not check for other Close Call hits.

Press [Hold / 

Turn [Scroll Control] to cancel the monitoring condition. Then the scanner checks the remaining CC Bands. If it gets a Close Call hit, the scanner alerts again. Otherwise, it returns to the previous mode.

Press [L/O] once to temporarily lock out the frequency. The scanner displays "Temporary L/O".

Press [L/O] twice in a second to permanently lock out the frequency. The scanner displays "Locked Out" then resumes searching from the next frequency.

The scanner stays on the frequency until the Delay time expires even if the transmission ends. Then the scanner checks the remaining CC Bands. If it gets a Close Call hit, the scanner alerts again. Otherwise, it returns to the previous mode.

If all the bands are set to Off at Set CC Bands, the scanner does not check for Close Call hits. The scanner displays "Close Call" and "All Band Off!" and sounds an Error Tone when it tries to perform the Close Call check. Then the scanner sets CC Mode to Off of Set CC Mode.

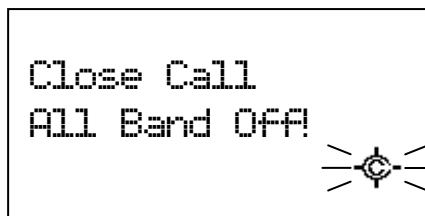

The scanner stays at this state.

In this state, press any key to turn all Close Call bands on.

Close Call Only

The scanner performs this by menu at Close Call Only. Or, long press [Hold / 

The scanner only tries to find a Close Call transmission.

“Close Call” will be displayed on the first line and the Close Call meter is displayed in the second line. This meter indicates the transmission signal level of each band.

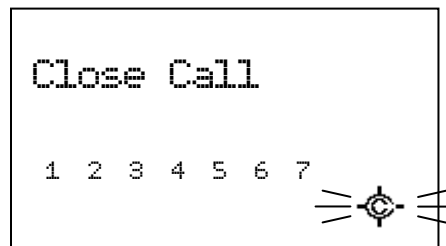

If the scanner has already received a Close Call hit and you press [Hold / 

Press the number keys from [1 / sr1] to [7 / att] to switch each band on or off. You can also use the menu to turn bands on or off. See Set CC Bands.

If the scanner gets a Close Call hit, the scanner displays "CC Found!" and "Press Any Key". And the band number that the found close call belongs to blinks.

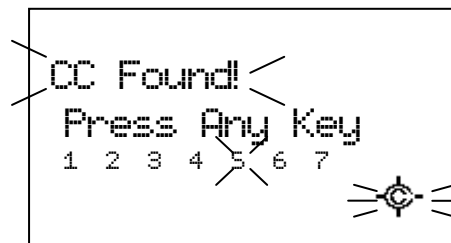

Press any key to see and hear the found frequency.

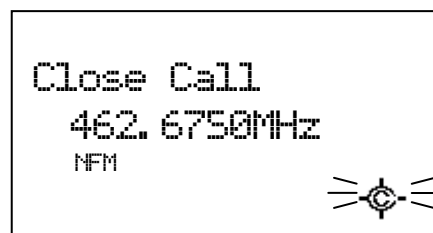

Press [Hold / 

In Close Call Only Mode, press [Menu] in Function Mode to go to Close Call Menu at Close Call.

Monitoring Close Call Transmission:

In this monitoring state, the scanner does not check other Close Call transmissions. Press [Hold / 

While the scanner is monitoring the transmission, turn [Scroll Control] to resume Close Call.

If all the bands are Off at Set CC Bands, the scanner cannot check for Close Call hits. The scanner displays "All Band Off!" and sounds an Error Tone. In this state, press any key to turn all the Close Call bands on.

Close Call Hold

In Close Call Hold, the scanner holds on the current Close Call hit frequency even if the transmission ends. The scanner displays "HOLD" and the held frequency. The Close Call Icon blinks and the modulation type is displayed.

For example, if the scanner finds a transmission on 174.0000 MHz, it displays as follows.

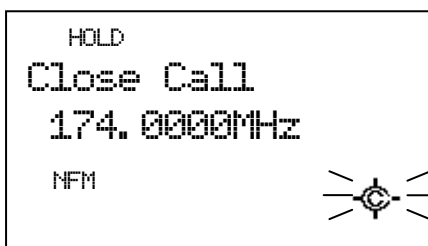

In this condition, the scanner does not check for other Close Call hits.

While holding on a frequency, turning [Scroll Control] goes to Quick Search Hold with the held frequency. And Close Call Mode will be set to off.

Press [Hold / 

*The previous state is one of these modes: Scan Mode, Scan Hold Mode, each Search Mode, each Search Hold Mode, Close Call Only Mode.

Close Call Auto Store

The scanner will automatically store Close Call hits. You can set this function using menu CC Auto Store.

During Close Call Auto Store operation, "SEARCH AND STORE" will scroll on the first Line and the Close Call meter that indicates the transmission signal level of each band will be shown in the second line.



If the scanner finds a Close Call transmission, it displays "CC Found!" on the first line. Then it performs duplication check in the "Close Call" System and displays "Memory Check" on the first line. While storing the frequency to Memory, it displays "Storing" on the first line.

The scanner will stop storing if the number of found frequencies reaches Max Auto Store. Then it displays "Limit Reached" and sounds a Confirmation Tone.

When it exceeds a limit for creating a System/Group/Channel while storing, the scanner stops storing. Then it displays "Over Limit" and sounds an Error Tone.

If the scanner's memory becomes full during the storing operation, it displays "Memory Full" on the first line and sounds an Error Tone.

The scanner does not automatically exit from CC Auto Store Mode.

Pressing [Hold / 

Pressing [Scan / srch] exits this mode and goes to Scan Mode.

Pressing [Menu] exits this mode and goes to Menu Mode. If you exit from Menu Mode, it goes to Close Call Only Mode.

Pressing [Menu] in Function Mode exits this mode and goes to the Close Call Menu.

Pressing [Scan / srch] in Function Mode prompts "Quick Search?" and exits this mode. Then press [E / yes / gps] to go to Quick Search Mode, press [. / no / pri] to go to Search Menu, press [L/O] to cancel the prompt and go to Close Call Only Mode, or press [Hold / 

CC Hit with Scan

The scanner stores the detected frequency in the "Close Call Hits" system. When the scanner is turned off, the stored frequencies are lost.

This system can store up to 10 frequencies. When there are already 10 frequencies in the "Close Call Hits" system, storing a new frequency overwrites the oldest one.

If this system does not have frequencies, the scanner does not scan this system.

The scanner does not store frequencies you skipped by pressing [L/O].

You set the Quick key, lockout state, number tag and hold time for this system at *Hits with Scan*.

Direct Entry / Quick Save / Go to Quick Search Hold Mode

Whenever it is in Close Call Hold Mode, you can enter a frequency or a TGID by pressing [0-9] or [. / no / pri] key, then press [E / yes / gps] to quickly store the entry.

(See *Direct Entry* for details.)

When the scanner monitors or holds on a Close Call transmission, press [E / yes / gps] to quickly store the current frequency.

While monitoring a Close Call frequency, if you turn [Scroll Control], the scanner goes to Quick Search Hold Mode with the frequency.

Key Operation During Close Call Only Mode

Normal Mode

[Scroll Control] knob

While monitoring a frequency, turn this knob to resume close call searching.

[Scan / srch] key

Press this key to go to Scan Mode.

[Hold /] key

If the scanner has already received a Close Call hit, press this key to hold on the frequency.

If not, the scanner will sound an Error Tone.

[L/O] key

While monitoring a frequency, press this key to temporarily lock out the current frequency. When the scanner is turned off, the frequency is unlocked.

Press this key twice in a second to permanently lock out the current frequency. When the scanner is turned off, the frequency stays locked out.

Long press this key to unlock all frequencies that are locked out in Search Mode and Close Call Mode.

[1 - 7] key

Press these keys to turn on/off each Close Call Band. This operation also can be done in menu Set CC Bands.

[E / yes / gps] key

While monitoring a frequency, press this key to quickly store the current frequency.

[Menu] key

Press this key to go to the Menu Mode at Top Menu.

Function Mode

[Scan / srch] key

Press this key to display the prompt for starting Quick Search.

The scanner displays the prompt. Press [E / yes / gps] to start Quick Search, press [./ no / pri] to go to Menu Mode at Search for..., press [L/O] to cancel the prompt or press [Hold / ] to go to Quick Search Hold Mode.

[Hold / ] key

Press this key to set the Close Call Mode to off and go to Scan Mode.

[L/O] key

Press this key to go to Rvw Search L/O.

[1 - 3 / sr 1 - 3] key

Press this key to start searching the search range set at Set Search Key.

[4 / LEFT / ifx] Key

While monitoring a frequency, press this key to exchange IF (intermediate frequency) for the current frequency.

[7 / att] key

Press this key to toggle the attenuator state for Close Call bands.

Long press this key to toggle the global attenuator status.

[8 / rev] key

Long press this key to show the reverse frequency for the current frequency.

And release this key to return to the current frequency.

[9 / mod] Key

Press this key to change the modulation.

[0 / WX] key

Press this key to change WX Alert Priority Mode.

Long press this key to start WX Scan.

[E / yes / gps] key

Press this key to change to the GPS Mode.

[Menu] key

Press this key to go to Close Call

Key Operation During Close Call Hold Mode

Normal Mode

[Scroll Control] knob

Turn this knob to go to the Quick Search Hold Mode.

[Scan / srch] key

Press this key to go to Scan Mode.

[Hold / ] key

Press this key to return to previous mode.

[L/O] key

Press this key to temporarily lock out the current frequency. When the scanner is turned off, the frequency is unlocked.

Press this key twice in a second to permanently lock out the current frequency. When the scanner is turned off, the frequency stays locked.

Long press this key to unlock all frequencies that are locked out in Search Mode and Close Call Mode.

[1 - 9, 0] key

Press this key to input a frequency or a TGID for Direct Entry.

[. / no / pri] key

Press this key to input "i" for Direct Entry.

[E / yes / gps] key

Press this key to quickly store the current frequency.

[Menu] key

Press this key to go to the Menu Mode at Top Menu.

Function Mode**[Scan / srch] key**

Press this key to display the prompt for starting Quick Search.

The scanner displays the prompt. Press [E / yes / gps] to start Quick Search, press [. / no / pri] to go to Menu Mode at Search for..., press [L/O] to cancel the prompt or press [Hold / 

[Hold / 

Press this key to set the Close Call Mode to off and go to Scan Mode.

[L/O] key

Press this key to go to Rvw Search L/O.

[1 - 3 / sr 1 - 3] key

Press this key to start searching the search range set at Set Search Key.

[4 / LEFT / ifx] Key

Press this key to exchange IF (intermediate frequency) for the current frequency.

[7 / att] key

Press this key to toggle the attenuator state for Close Call bands.

Long press this key to toggle the global attenuator status.

[8 / rev] key

Long press this key to show the reverse frequency for the current frequency.

And release this key to return to the current frequency.

[9 / mod] Key

Press this key to change the modulation mode.

[0 / WX] key

Press this key to change WX Alert Priority Mode.

Long press this key to start WX Scan.

[E / yes / gps] key

Press this key to change to the GPS Mode.

[Menu] key

Press this key to go to Close Call

WEATHER SCAN MODE

You can start scanning the 10 Weather Channels either by using the menu or by pressing Function and long pressing [0 / WX].

The scanner scans the 10 Weather Channels normally, or alerts when a 1050 Hz Weather Alert Tone or a SAME Weather Alert is broadcast on a Weather Channel.

You cannot lockout any Weather Channel.

*Close Call function does not work while during Weather Scan Mode even if "Set CC Mode" is "CC DND" or "CC Pri".

Normal Weather Scan

The scanner starts this when you select Weather Scan in Menu Mode at WX Operation.

The scanner scans 10 Weather Channels normally.

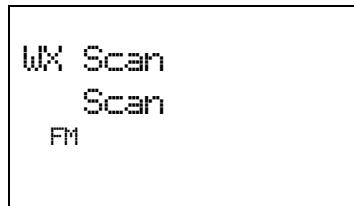

When it finds a broadcast, it stops on the Channel.

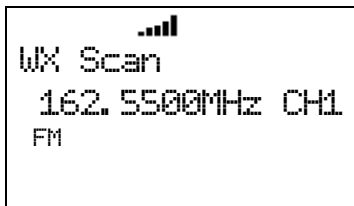

If the signal is lost, the scanner resumes scanning for Weather Channels.

Weather Alert Scan

The scanner starts this when you either select the Weather Alert function in Menu Mode at Weather Alert or press Function key and [0 / WX] key in Normal Weather Scan Mode to start this mode.

The scanner scans 10 Weather Channels and alerts when it detects a 1050 Hz Weather Alert Tone or a SAME Weather Alert.

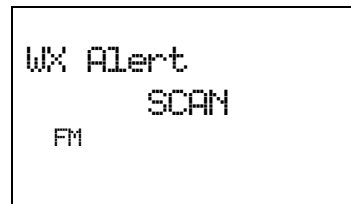

If it is set to Alert Only, the scanner immediately sounds a Weather Alert Siren (for Weather Alert Tone) and displays "Warning WX" and "WX Alert" when it detects the 1050 Hz Weather Alert Tone. This Siren sounds as long as 1050 Hz Weather Alert Tone is broadcasted, or press any key to stop the Siren. Then the scanner opens squelch and remains on the Weather Channel.

If you press any key, the scanner goes to WX Scan Hold Mode and releases the mute.

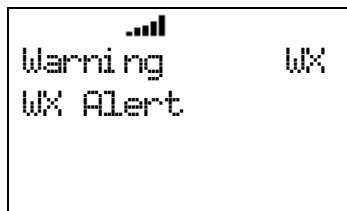

If the scanner is set to one of the SAME Groups, the scanner attempts to decode the SAME data packets that precede the Alert Tone. Then the scanner sounds a Weather Alert Siren (for Warning, Watch or Advisory) when the received County is the same as the programmed data. The scanner displays warning level as "Warning WX", "Watch WX" or "Advisory WX" on the first line and it displays the decoded Event Code on the second line. (See: CEA2009-SAME EVENT CODE for displayed characters.)

If you press any key, the scanner goes to Weather Scan Hold Mode and releases the mute and remains on the Weather Channel.

If the scanner decodes the EOM (= End of Message) in Weather Alert Scan Mode, it returns to the mute condition. However if the scanner is already in Weather Scan Hold Mode, it will not mute by decoding the EOM.

For example, the scanner displays as follows when it decodes the SAME data that has an Event Code of "EAN".

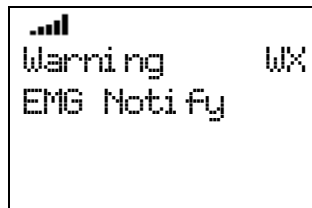

If the scanner is set to All FIPS, the scanner sounds a Weather Alert Siren (for Warning, Watch or Advisory) when it decodes the SAME data packets that precede the Alert Tone. It displays the warning level and Event Code, then opens squelch and remains on the Weather Channel.

*When the scanner detects the SAME data, it sounds each Weather Alert Siren for a maximum of 8 seconds. But you can suspend the siren by pressing any key.

*When the scanner detects the 1050 Hz Weather Alert Tone, it sounds Weather Alert Siren as long as 1050 Hz Weather Alert Tone is broadcasted, or press any key to stop the Siren.

Weather (Alert) Scan Hold

Press [Hold / 

The scanner displays "HOLD" icon and displays "WX Scan" or "WX Alert" on the first line and the Channel Number and frequency on the second line. The scanner checks only the held Channel.



The scanner does not sound until it detects the 1050 Hz Weather Alert Tone or decodes the SAME data in Weather Alert Scan Hold. See: [*Weather Alert Scan*](#) for operation when it detects the 1050 Hz Weather Alert Tone or decodes the SAME data.

Press [Hold / 

Weather Alert Priority (WX Alt Priority)

The scanner interrupts scanning or searching every 5 seconds and checks whether there is a 1050 Hz Weather Alert Tone on Weather Channels.

If the tone is detected, the scanner stays on to the Weather Channel and sounds a Weather Alert Siren (for Weather Alert Tone). Pressing any key stops this Siren.

After the Siren stops, the scanner opens squelch and remains on the Weather Channel.

If you presses any key again, the scanner goes to Weather Scan Hold Mode.

*WX Alt Priority function does not work while the scanner is in Weather Scan Mode, "Search and Store" Mode, Tone-Out Mode or CC Auto Store.

Direct Entry / Quick Save

When the scanner is holding on a Weather Channel, enter a frequency or TGID by pressing the number and decimal keys, then press [E / yes / gps] to quickly store the entered data.

When the scanner is holding or monitoring a Weather Channel, press [E / yes / gps] to quickly store the frequency.

Key Operation During Weather (Alert) Scan Mode

Normal Mode

[Scroll Control] knob

Turn this knob to resume Weather Scan.

[SCAN / srch] key

Press this key to go to Scan Mode.

[Hold /

Press this key to go to Weather Scan Hold Mode.

[E / yes / gps] key

Press this key to quickly store the current frequency.

[MENU] key

Press this key to go to the Menu Mode *at Top Menu*.

Function Mode

[SCAN / srch] key

Press this key to display the prompt for starting Quick Search.

The scanner displays the prompt. Press [E / yes / gps] to start Quick Search, press [./ no / pri] to go to Menu Mode at Search for..., press [L/O] to cancel the prompt or press [Hold / 

[1 - 3 / sr 1 - 3] key

Press this key to start searching the search range set at Set Search Key.

[4 / LEFT / ifx] Key

While monitoring a frequency, press this key to exchange IF(intermediate frequency).

[7 / att] key

Press this key to toggle the attenuator state for the search range.

Long press this key to toggle global attenuator.

[0 / WX] key

Press this key to change to WX Scan or WX Alert Scan.

If you press this key in WX Scan Mode, you can select how the WX Scan works and the scanner starts WX Alert Scan.

Or, the scanner immediately starts WX Scan when this key is pressed in any WX Alert Scan Mode.

[E / yes / gps] key

Press this key to change to the GPS Mode.

[MENU] key

Press this key to go to WX Operation.

Key Operation During Weather (Alert) Scan Hold Mode

Normal Mode

[Scroll Control] knob

Turn this knob to select the Weather Channel.

[SCAN / srch] key

Press this key to go to Scan Mode.

[Hold /

Press this key to resume each Weather Scan.

[1 - 9, 0] key

Press this key to enter numbers and go to Direct Entry.

[./ no / pri] key

Press this key to input decimal point, hyphen or "i" for Direct Entry.

[E / yes / gps] key

Press this key to quickly store the current frequency.

[MENU] key

Press this key to go to the Menu Mode *at* Top Menu.

Function Mode

[SCAN / srch] key

Press to display the Quick Search prompt. Press [E / yes / gps] to start Quick Search, press [. / no / pri] to go to Search for..., press [L/O] to cancel the prompt or press [Hold / 

[1 - 3 / sr 1 - 3] key

Press this key to start searching the search range set at Set Search Key.

[4 / LEFT / ifx] Key

Press this key to exchange IF(intermediate frequency) for the current frequency.

[7 / att] key

Press this key to toggle the attenuator state for the search range.

Long press this key to toggle global attenuator.

[0 / WX] key

Press this key to switch between WX Scan or WX Alert Scan. If you press this key in WX Scan Mode, you can select how the WX Scan works and the scanner starts WX Alert Scan. The scanner immediately starts WX Scan when this key is pressed in any WX Alert Scan Mode.

[E / yes / gps] key

Press this key to change to the GPS Mode.

[MENU] key

Press this key to go to WX Operation.

TONE-OUT MODE

Select "Tone-Out Standby" in *Tone-Out for ...*

Note: In this function, Close Call and WX Priority don't operate.

Display during Tone-Out Mode

Tone-Out Standby

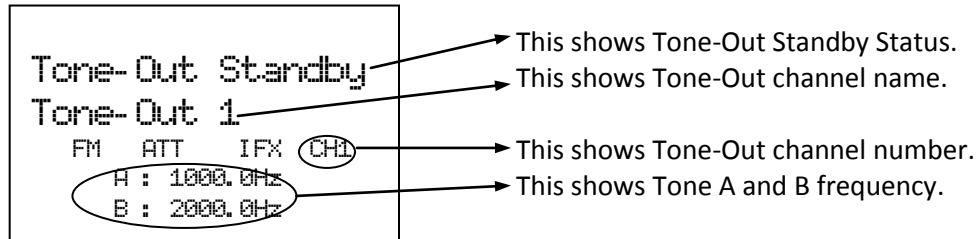

FM : These icons show the modulation type.

ATT : This icon shows the attenuator status of the current channel. When Global attenuator is on, this icon blinks.

IFX : This icon shows when the current channel is an IF exchange frequency.

Tone-Out Search

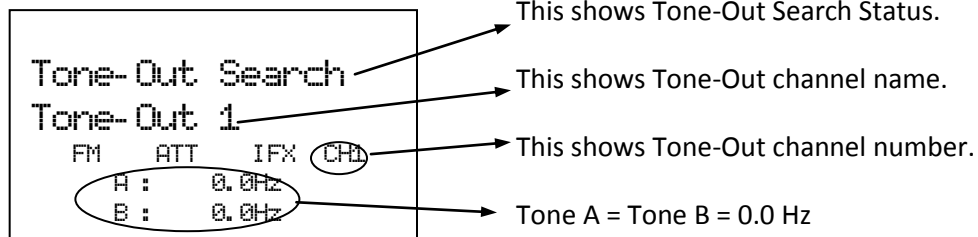

FM : These icons show the modulation type.

ATT : This icon shows the attenuator status of the current channel. When Global attenuator is on, this icon blinks.

IFX : This icon shows when the current channel is an IF exchange frequency.

Tone-Out Standby Mode

If at least one of Tone A and Tone B have a programmed tone, the scanner goes to Tone-Out Standby. While monitoring the Tone-Out frequency, the speaker is muted until matching Tones are detected.

- For two-tone pages, enter a value for Tone A and Tone B.
- For single-tone pages (alert by a single short tone), enter the tone value for Tone A and "0" for Tone B.
- For group tones (alert by a single long tone), enter "0" for Tone A and the tone value for Tone B.

When you set a tone value for Tone A and Tone B, if a transmission is detected, the scanner checks whether the tone is corresponding to Tone A.

If the first tone matches Tone A, the scanner confirms that the tone is present for more than 250ms.

Then the second tone is confirmed whether it detects second tone less than 500ms.

If the second tone matches Tone B and the tone is present for more than 100ms, the scanner opens squelch and activates the alert tone and alert light that you set for this tone set. Then the scanner goes to Tone-Out Hold Mode.

When you set a tone value for Tone A and "0" for Tone B, the scanner confirms that Tone A matches the first tone and is present for the following range.

Tone A: 1.25 – 3.75 sec

Then, the scanner goes to Tone-Out Hold Mode.

Or, when you set "0" for Tone A and a tone value for Tone B, the scanner confirms that Tone B matches the first tone and it is present for more than 3.75 sec.

Then, the scanner goes to Tone-Out Hold Mode.

Multi-Channel Monitoring

The scanner can check multiple tone combination for channels that have the same settings for frequency, Modulation and Attenuator.

For example, the scanner can check tone combination from CH 1 to CH3 at the same time when you program the scanner with the following settings.

	Frequency (MHz)	Modulation	Attenuator	Tone A (Hz)	Tone B (Hz)
CH 1	137.0000	Auto*(NFM)	Off	1000.0	2000.0
CH 2	137.0000	Auto*(NFM)	Off	2200.0	3200.0
CH 3	137.0000	NFM	Off	1500.0	2500.0
CH 4	137.0000	NFM	On	1800.0	2800.0
CH 5	137.0000	FM	Off	2000.0	3000.0
CH 6	138.0000	Auto*(NFM)	Off	1000.0	2000.0

*Modulation setting "Auto" follows the initialization of Band Coverage. However, when modulation of the frequency in Band Coverage is not FM or NFM, it is forced to FM. And "Auto" is compared as NFM or FM with other channel's setting.

*The scanner detects the Tone on the channel that its number is the smallest if you set the same tone in multiple channels.

While Tone-Out Standby Mode for Multi-Channel Monitoring, the scanner switches the channel display every 2 seconds. But the scanner checks all Tones for Multi-Channels simultaneously.

When one of the tone combinations is detected, it goes to Tone-Out Hold Mode.

Tone-Out Search Mode

When both Tone A and Tone B are set to 0.0Hz, this channel will be treated as a Tone-Out Search channel. The scanner starts the Tone-Out Search. During monitoring the Tone-Out frequency, the speaker is muted until Tones are detected.

In Tone-Out Search mode, if a transmission is detected, the scanner starts to check for two-tone pages, single-tone pages and group tones.

For two-tone pages, Tone A must be present for more than 250ms, Tone B must be present for more than 100ms, and the time gap between Tone A and Tone B must less than 500ms.

For single-tone pages, the Tone must be present between 1.25-3.75 seconds.

For group tones, Tone must be present for more than 3.75 seconds.

If one kind of these tones is detected, the scanner begins to check whether it has been registered in another tone-out channel with the same setting for frequency, Modulation and Attenuator. If it has been registered, the scanner goes to Tone-Out Hold Mode with the registered channel number. If not, the scanner goes to Tone-Out Hold Mode with the current Tone-Out search channel number.

Note: A Tone-Out Search channel is not treated as Multi-Channel even it has the same setting of frequency, Modulation and Attenuator with other channels.

When in Tone-Out Search Mode, scanner will not switch the channel display each 2 seconds for the Multi-Channel.

Tone-Out Hold Mode

You can hear the transmission in Hold Mode. When the transmission ends and the delay time expires, the scanner returns to standby condition or search condition. Or pressing [Hold / >] also returns to standby condition or search condition.

The scanner displays the following in Tone-Out Hold Mode.

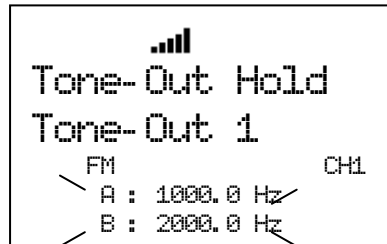

You can change to Hold Mode from Standby Mode of Search Mode by pressing [Hold / >]. Tone-out Hold Mode has no timeout.

If the scanner detects a new tone-out sequence that has not been register yet. The found tone-out sequence will flash.

You can return to the Tone-Out Search Mode by pressing [Hold / >].

If you press [E / yes / gps], you will be prompted to save the new detected tone-out sequence.

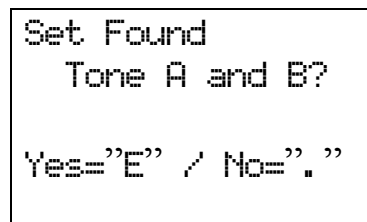

Press [E / yes / gps] to save the new tone-out sequence and move to the tone-out setting menu Tone-Out Settings. Press [./ no / pri] to cancel the new tone-out sequence and move to the tone-out setting menu Tone-Out Settings.

Note: If you change the Channel by turning [Rotary] when in Hold Mode, the Hold condition is canceled and it moves to next channel.

Key Operation During Tone-Out Mode

Normal Mode

[Scroll Control] Knob

Turn this knob to change the channel. Then the scanner is muted if it releases the mute.

[Scan / srch] key

Press this key to go to Scan Mode.

[Hold /] Key

In Tone-Out Standby Mode or Tone-Out Search Mode, press this key to go to Tone-Out Hold Mode and release the mute.

In Tone-Out Hold Mode, press this key to go to Tone-Out Standby Mode or Tone-Out Search Mode, and the scanner is muted.

[1 - 9, 0] key

Press this key to enter a frequency or a TGID for Direct Entry.

[. / no / pri] key

Press this key to input "i" for Direct Entry.

[E / yes / gps] key

Press this key to go to the channel menu at *Tone-Out Settings*.

[Menu] Key

Press this key to go to the Menu Mode *at* Top Menu.

[L/O] Key

This key will be ignored.

Function Mode

[Scan / srch] key

Press this key to display the prompt for starting Quick Search.

The scanner displays the prompt. Press [E / yes / gps] to start Quick Search, press [. / no / pri] to go to Menu Mode at Search for..., press [L/O] to cancel the prompt or press [Hold / 

[Hold /

Press this key to go to Close Call Mode.

Long press this key to go to Close Call Only Mode

[1 - 3 / sr 1 - 3] key

Press this key to start searching the search range set at Set Search Key.

[4 / LEFT / ifx] key

Press this key to exchange IF (intermediate frequency) for the current frequency.

[7 / att] key

Press this key to toggle the attenuator setting.

Long press this key to toggle the global attenuator setting.

[9 / mod] key

Press this key to change the modulation.

[0 / WX] key

Press this key to change WX Alert Priority Mode.

Long press this key to start WX Scan.

[E / yes / gps] key

Press this key to change to the GPS Mode.

[Menu] key

Press this key to go to *Tone-Out for ...*.

GPS MODE

By connecting a GPS Unit, the scanner can operate the following functions.

- Automatic lockout control for Scan Systems, Sites, and Channel Groups
- Navigation to POI (Point Of Interest)
- Location Alerts

This mode guides to the destination by connecting a GPS Unit to the serial port of the scanner and receiving location data through it.

You must set the scanner's baud rate to the same as the GPS unit. This is normally 4800 bps

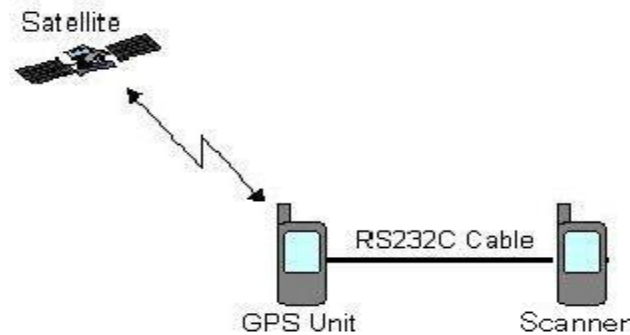

The formats of the GPS data that the scanner can receive are only GGA (Global Positioning System Fix Data) and RMC (Recommended Minimum Specific GNSS Data) based on "NMEA-0183 ver.3.01".

Display Mode in GPS Mode

There are 6 kinds of Display Mode in GPS Mode; GPS DATA, ETA, Clock, Elevation, Speed and Location. And there are two displays for a GPS Data receipt error.

If you do not select any POI, the Display Mode can be selected from GPS DATA and Location. Press [6 / RIGHT / disp] in Function Mode to change the Display Mode to the opposite side.

Or, if a POI is selected, the Display Mode can be selected from ETA, Clock, Elevation, Speed and Location. Press [6 / RIGHT / disp] in Function Mode to toggle the Display Modes in order.

*In GPS Mode, the 4th line displays the background operation of Scanner Mode. However, nothing is displayed on this area when the scanner goes to GPS Mode from Band Scope Mode.

Examples of each Display Mode are as follows.

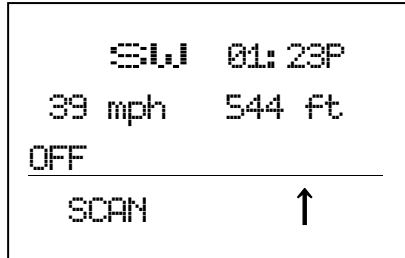

GPS DATA Display

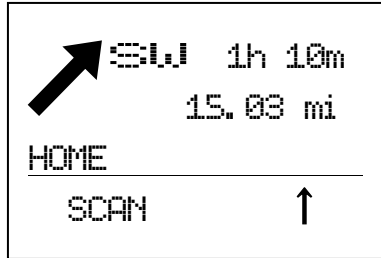

ETA Display

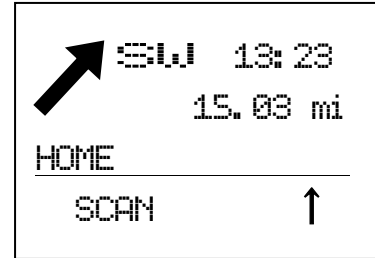

Clock Display

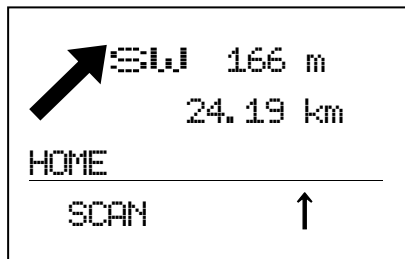

Elevation Display

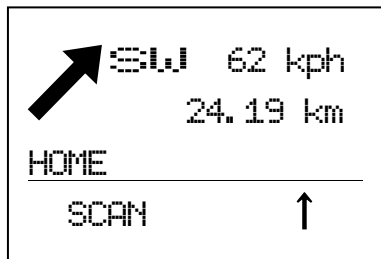

Speed Display

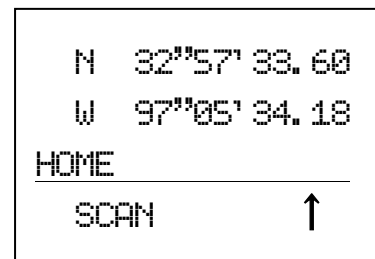

Location Display

GPS DATA Display

This Display Mode displays the direction of travel, the time, the speed and the elevation.

- The left side of the 1st line displays the current direction of travel.
- The right side of the 1st line displays the present time.
- The left side of the 2nd line displays the current speed.
- The right side of the 2nd line displays the elevation of the current location.
- The 3rd line always displays "OFF" because a POI is not selected.

ETA / Clock / Elevation / Speed Display

These Display Modes display the direction and the distance for the selected POI, the direction of travel and individual information.

- The large arrow shows the direction to the selected POI.
- The left side of the 1st line displays the current direction of travel.
- The 2nd line displays the distance to the selected POI.
- The right side of the 1st line displays individual information.
 - ETA Display Mode shows the ETA (Estimated Time for Arrival) to the selected POI.
 - Clock Display Mode shows the present time.
 - Elevation Display Mode shows the elevation of the current location.
 - Speed Display Mode shows the current speed.

The name of the selected POI is displayed on 3rd line.

Location Display

This Display Mode displays the latitude and longitude of the current location.

- The 1st line displays the latitude of the current location.
- The 2nd line displays the longitude of the current location.
- The 3rd line displays "OFF" (when a POI is not selected) or the name of the selected POI.

Display Formats of Each Information:

The advance direction:	This is one of N, NE, E, SE, S, SW, W and NW.
The time:	The time is displayed as " <i>hh:mm</i> " (<i>hh</i> : hour, <i>mm</i> : minute). If "12H" is selected at <u>Set Time Format</u> , "A" or "P" is displayed at a right end.
The speed:	This is a triple digits. According to the setting of <u>Set Unit</u> , "mph" (mile/hour) or "kph" (km/hour) is displayed for a unit.
The elevation:	This is displayed as " <i>EEEE</i> ft" (<i>EEEE</i> : elevation of a positive number) or " <i>-EEE</i> ft" (<i>EEE</i> : elevation of a negative number) using four digits. According to the setting of <u>Set Unit</u> , "ft" (feet) or "km" is displayed for a unit.
The direction for the POI:	One of eight directions is shown. There are "↑", "↗", "→", "↘", "↓", "↙", "←" and "↖". In Function Mode, this arrow changes to small one.
The distance for the POI:	This is displayed as " <i>DDDD.dd</i> mi" (<i>DDDD.dd</i> : distance). According to the setting of <u>Set Unit</u> , "mi" (mile) or "km" is displayed for a unit.
The ETA to the POI:	This is displayed as " <i>hhh mmm</i> " (<i>hh</i> : hour, <i>mm</i> : minute).
The latitude:	This is displayed as "N" or "S" and " <i>DD°MM'SS.ss</i> " (for DMS format) or " <i>DD.dddddd</i> " (for DEG format).
The longitude:	This is displayed as "W" or "E" and " <i>DDD°MM'SS.ss</i> " (for DMS format) or " <i>DDD.dddddd</i> " (for DEG format).

Error Display

When the scanner does not receive GPS data, the scanner displays "No GPS Input".

When the scanner is searching for the satellite, the scanner displays "Searching for Satellite".

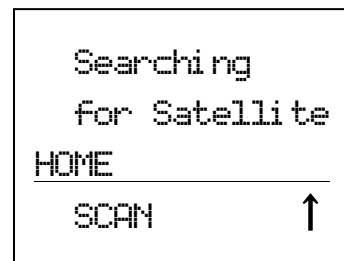
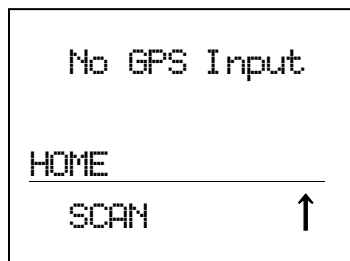

You can select a POI by turning [Scroll Control] knob even if the scanner displays an error message.

Location Alert Operation

This alerts you when you approach a destination, a Dangerous Xing or a Dangerous Road by ringing an alert.

Location Alert System Types have "POI (Point Of Interest)", "Xing (Dangerous Xing)" and "Road (Dangerous Road)".

Display with Location Alert

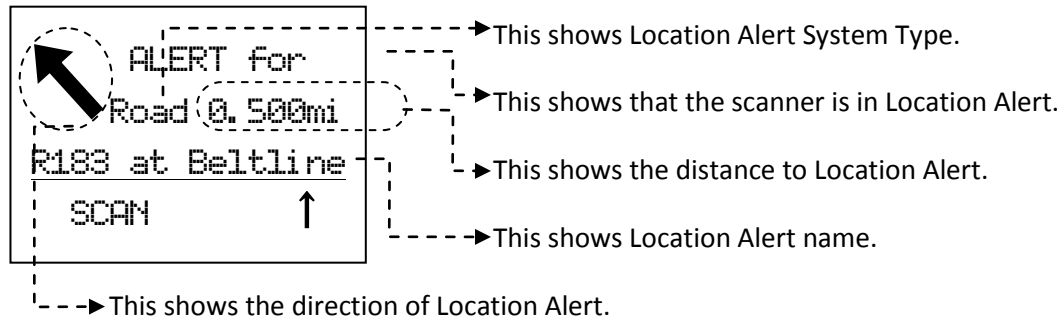

While displaying the **F** icon, Location Alert arrow changes to a small font.

Point Of Interest

The alerts you by ringing an alert if you approach the selected destination. The timing to which the alert rings is set up in Set LocationInfo. Or, the alert is set up in Set Alert.

The screen displays "ALERT for" on the first line. And the second line displays "POI" as Location Alert System Type and the distance to the destination.

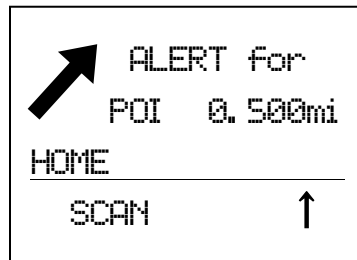

Dangerous Xing / Road

The scanner may ring an Alert three times at different timings.

The screen displays "ALERT for" on the first line. And the second line displays the Location Alert System Type and the distance to the Alert Location. An arrow which shows the direction of Alert Location is displayed too. Alert Light is turned on. (See: Set Alert Light.)

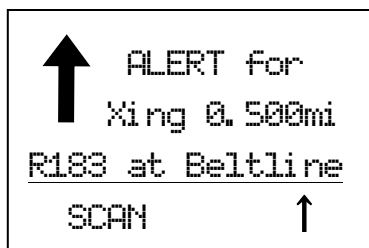

Dangerous Xing

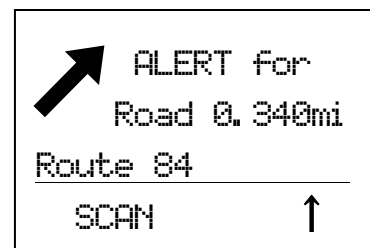

Dangerous Road

There are three ranges for Alert, 1.0mile, 0.50 mile and 0.10 mile if you select "mile" as the unit. If you select "km" as the unit, the alert distances are 1.0km, 0.50 km and 0.10 km. (See: Set Unit)

The scanner alerts only once for each range when it meets both of the following two conditions.

- First condition is heading for Alert Point. This is cleared when you heading is within $\pm 45^\circ$ of the value that is set in *Set Heading*.
- The second condition is speed. It meets this condition when the current speed exceeds the speed that is set in *Set Speed Limit*.

For example, see the following illustration. Car 1 is traveling within the range of the alert location point and its heading is within the point's set direction.

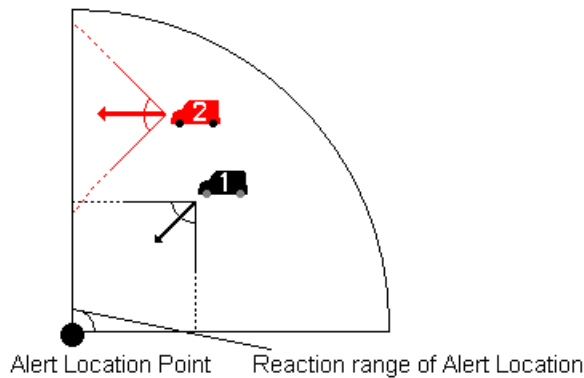

Car 2 is traveling within the range of the alert location, but its direction is outside the point's set direction.

If Car 1 is running at a speed higher than the limit set for the point, the scanner rings an Alert, the display changes to Location Alert Mode and the Alert Light is turned on.

If Car 1 is running at speed lower than the limit set for the point, the scanner does not ring an alert, the display changes to Location Alert Mode.

If Car 1 accelerates to a speed higher than the limit set for the point after it enters range, the scanner will ring an Alert and the Alert Light is turned on.

On the other hand, no Alert (Alert display, Alert Light, and Alert Beep) will sound for Car 2 regardless of its speed.

Lockout Operation

The scanner temporarily locks out the current Location Alert if you press [L/O] once while an alert for the location is active. The scanner automatically unlocks the locked out location when it moves 4 miles or more from the Alert Point.

The scanner permanently locks out the current Location Alert if you press [L/O] twice in a second. As long as you do not unlock the locked out location at menu (See: *Set Lockout*), Location Alert Operation and Alert Light for the locked out location does not work.

Turn [Scroll Control] during a location alert to temporarily lockout the displayed Location Alert.

Priority for Location Alert

When a Location Alert with a higher priority occurs during a Location Alert, the current Location Alert is canceled and the scanner alerts for the Location with the high priority.

The priority order is as follows:

- 1) Dangerous Road
- 2) Dangerous Xing
- 3) Point of Interest

GPS Operation during Scanner Display

If a Location Alert occurs when the scanner is displaying the scanner screen, the scanner displays the Location Alert data in reverse type on the bottom line and the Alert Light turns on. The scanner displays the direction of the Location Alert, Location Alert system type and the distance to the Location Alert.

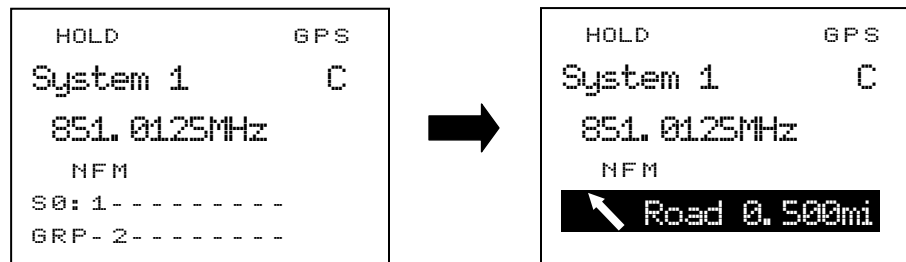

During the Location Alert, the scanner carries out the Location Alert operation with the scanner operation display. When the Location Alert operation finishes, the scanner returns to the usual scanner display.

Registration of Location Information

You can store current location data and the heading value by long pressing [E / yes / gps] key in Function Mode.

The moment you press [E / yes / gps] key in Function Mode, the scanner holds the current location data.

Then the scanner displays the dialog for selecting a location type. By pressing [E / yes / gps] for type selection, registration is completed and the name and location of stored location are displayed.

The stored data is named as "T YYMMDD hhmmss" that shows a type, date and the time.

Note: "T" means location system type. (P : POI / R : DRD / X : DXG) "YY" means year. "MM" means month. "DD" means day. "hh" means hour. "mm" means minute. "ss" means second.

For example, when a default name is "X 091020 102554", the system type is Dangerous Xing and was stored in 2009/10/20 10:25:54.

However, if the connection of GPS Unit is invalid, the scanner beeps an error tone when [E / yes / gps] is pressed.

*You can register current Location Information to a previously stored Location, too. For this operation, long press [FUNC] + [E / yes / gps] key in Review Location Mode. (See [Review Location Mode](#) for details.)

Review Location Mode

*In this mode, scanning/searching operation, navigation and Location Alert operation are invalid.

You can review all created Locations.

In GPS Mode, press [E / yes / gps] to go to Review Location Mode.

At first, the last displayed Location is selected.

The first line displays "Review Location" and the second line displays the Name of the Location. Location Type, Lockout status and GPS icon are displayed above the first line. Other parameters are displayed under the second line.

For POI, Range is displayed as "RANGE:0.10 MILE" or "RANGE:0.10 KM". For Dangerous Xing or Dangerous Road, Heading and Limit Speed are displayed as "HEAD:xxx" and "LS: 75M" (or "LS:75K"). The xxx is one of ALL, N, NE, E, SE, S, SW, W and NW.

Latitude and Longitude are displayed at the bottom of the screen.

Displays of each Type are as follows.

```
POI  L/O  GPS
Review Location
Hollywood
RANGE: 0.10 MILE
N 00°00'00.00
W 000°00'00.00
```

POI

```
DXG  L/O  GPS
Review Location
Crossroad
HEAD: ALL LS: 75M
N 00°00'00.00
W 000°00'00.00
```

Dangerous Xing

```
DRD  L/O  GPS
Review Location
Crossroad
HEAD: NW LS: 75K
N 00.000000
W 000.000000
```

Dangerous Road

Key Operation

Key Operation of Review Location Mode is different from normal GPS Mode.

Turn [Scroll Control]: Select a Location from all stored Locations. In this mode, Locations are sorted by Location Type. The order of Type is POI, Dangerous Xing and Dangerous Road. Locations are sorted by Name in each Type.

Turn [Scroll Control] in Function Mode: This skips to the location that starts with the next letter of the alphabet.

Press [SCAN / srch]: Go to Scan Mode.

Press [Hold / 

Press [L/O] key: Change the lockout status of the displayed Location.

Long press [L/O]: Unlock all Locations of the current Type. "Unlocked All TTTs?" and "Yes="E" / No="." are displayed. The "TTT" shows Location Type as POI, DXG or DRD.

	If you press [E / yes / gps], the scanner unlocks all locations of the current Type.
	If you press [. / no / pri], the scanner returns to the previous mode without unlocking.
Long press [L/O] in Function Mode:	Display the prompt "Unlock All Locations?" to unlock all Locations of all Types.
	If you press [E / yes / gps], the scanner unlocks all locations.
	If you press [. / no / pri], the scanner returns to the previous mode without unlocking.
Press [. / no / pri]:	Return to GPS Mode.
[E / yes / gps]:	Go to the location edit menu for the selected Location. <ul style="list-style-type: none"> • The construction of this edit menu is the same as the Menu of <i>POI Settings</i> or <i>Dangerous Xing / Road Settings</i>. However, pressing [MENU] in this edit menu returns to Review Location Mode, and pressing [L/O] in this menu goes to GPS Mode. • If you select "New Location" in the editing menu, the scanner returns to Review Location Mode with new Location activation. • If you select "Delete Location" in the editing menu, the scanner returns to Review Location Mode and the next Location is selected. If you've deleted all locations, the scanner returns to the GPS Mode immediately.
Long press [E / yes / gps] in Function Mode:	Overwrite the Latitude/Longitude of selected Location using the current Location Data from the GPS Unit. "Storing Location" is displayed and the scanner sounds an Exec Tone. <ul style="list-style-type: none"> • If the GPS connection is invalid, it can not overwrite and the scanner beeps an error tone when [FUNC] + [E / yes / gps] is pressed.
Press [MENU]:	Return to GPS Mode.

Key Operation During GPS Mode

*Refer to Review Location Mode for Key Operation of Review Location Mode.

Normal Mode

[Scroll Control] knob

Turn this knob to select a POI.

While displaying the **F** icon, the location alert arrow changes to a small font.

Turn this knob during a location alert to temporarily lockout the displayed Location Alert.

[SCAN / srch] key

Press this key to return to the previous mode in scanner screen.

[Hold /] key

This key works on scanner operation which is running in the background.

If scanner operation is Scan Mode or Search Mode, the scanner goes to Hold Mode by pressing this key. Or it is Scan Hold or Search Hold, the scanner resumes scanning or searching.

[L/O] key

Press this key once to temporarily lockout the current Location Alert during a Location Alert.

When the scanner is turned off, the frequency is unlocked. Or, the scanner automatically unlocks the locked out location when it moves 4 miles or more from the Alert Point.

Press this key twice in a second to permanently lockout the current Location Alert during a Location Alert.

When the scanner is turned off, these locations remain locked out.

[E / yes / gps] key

Press this key to go to Review Location Mode.

[MENU] key

Press this key to go to the Menu Mode at Top Menu.

Function Mode

[Scroll Control] knob

Turn this knob to skip to the location that starts with the next alphabetic character.

Press this knob to go to Normal Mode.

[L/O] key

Press this key once to temporarily lockout the current Location Alert during a Location Alert.

When the scanner is turned off, the frequency is unlocked. Or, the scanner automatically unlocks the locked out location when it moves 4 miles or more from the Alert Point.

Press this key twice in a second to permanently lockout the current Location Alert during a Location Alert.

When the scanner is turned off, these locations remain locked out.

[6 / RIGHT / disp] key

Press this key to change the GPS Display.

[E / yes / gps] key

Long press this key to store the current location.

[MENU] key

Press this key to go to the editing menu for the current location system.

BAND SCOPE MODE

Band Scope Mode searches a frequency range and displays the signal level in real time.

You can set the center frequency and span of the frequency range.

In Hold Mode, you can monitor the displayed frequency.

*Close Call, Priority Scan, Weather Scan and GPS functions do not work in Band Scope Mode.

Scope Mode

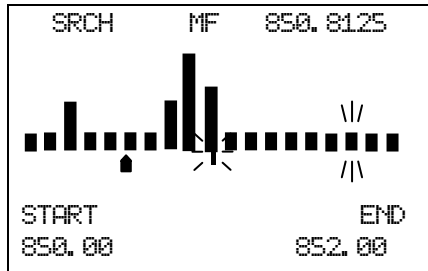

Search Mode with Normal Screen

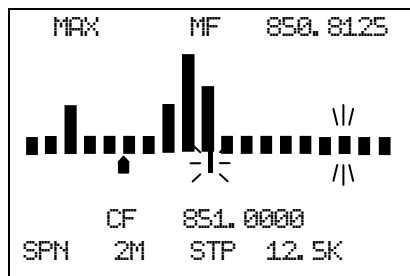

Search Mode with Setting Screen

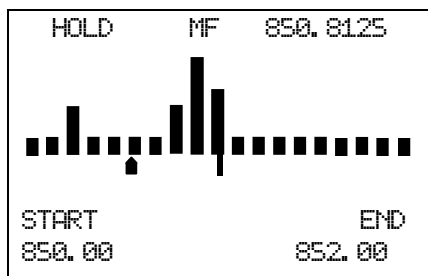

Hold Mode with Normal Screen

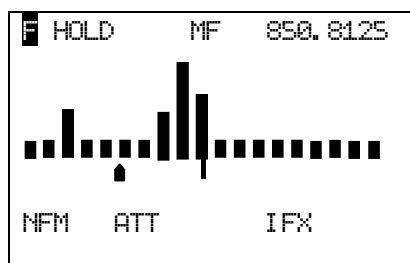

Hold Mode in Function Mode

SRCH	:	This icon appears while in Search Mode.
MAX	:	This icon appears while in MAX Hold Search Mode. This shows in the same place as " SRCH ".
HOLD	:	This icon appears while in Hold Mode. This shows in the same place as " SRCH ".
MF	850.8125:	This icon and number show the marker frequency.
	■	This icon shows the signal level.
	▲	This icon shows the marker point.
	■	This icon shows the center frequency point.
START	850.00:	This icon and number shows the start frequency of the search range.
END	852.00:	This icon and number shows the end frequency of the search range.
CF	851.0000	: This icon and number shows the center frequency.
SPN	2M:	This icon and parameter shows the frequency span.
STP	12.5K:	This icon and parameter shows the search step.
NFM	:	This icon shows the modulation type.
ATT	:	This icon appears when the attenuator state for a range is On.
IFX	:	This icon appears on the frequency has IF exchange On.

Search Mode

The scanner searches and displays the signals of the frequency range in real time.

The scanner displays "SRCH".

The frequency range expressed in 32 bars is determined by the center frequency and span.

If the frequency range includes outside of the range from 25.0000 to 1300.0000 MHz, the scanner does not search that range.

While searching, the center frequency icon and the bar which shows the current frequency blink.

The scanner starts from the lowest frequency of the frequency range and searches in ascending order.

If the scanner finds a transmission, the scanner displays a signal level (0-7) in the bar including the frequency.

If the scanner finds some signals in the bar, the strongest and the latest signal are displayed.

Note: If a signal is outside of band coverage, the scanner doesn't search it.

Press [FUNC] + [Scan / srch] in Max Hold Search Mode to go to this mode.

Max Hold Search Mode

The scanner searches the signals of the frequency range.

The scanner displays the frequency for the strongest signal.

The scanner displays "MAX".

The other functions are the same as Search Mode.

Press [FUNC] + [Scan / srch] in Search Mode to go to this mode.

Hold Mode

You can monitor frequency displayed in this mode.

The scanner displays "HOLD".

Center frequency icon and bars do not blink different from Search or Max Hold Search Mode.

You can select the frequency to monitor by moving the marker pointer.

Turn Scroll Control, the marker changes the frequency every step.

Turn Scroll Control in Function Mode, the marker changes the frequency every bar.

Press [Hold / 

General Operation

Normal Screen

This screen is usually displayed in Band Scope Mode.

This screen displays the start and end frequency of the range on the bottom line.

You can control the marker to monitor a frequency in Hold Mode and register the marker frequency as the center frequency.

Setting Screen

This screen is displayed to operate the band scope settings.

This screen displays center frequency of the range, search step and span of the range on the bottom line.

You can change these parameters.

Press [. / no / pri] while on the normal screen to display this screen.

In this screen, press [. / no / pri] to select the next setting item.

The icon of the selected item blinks.

You can change the selected item's parameter (except "CF") by turning the Scroll Control.

When the "CF" is selected, go to the edit frequency menu to change the center frequency by pressing [E / yes / gps]. (See [Edit Frequency](#).)

If you change a parameter, the scanner clears the search result and searches again.

The scanner returns to a normal screen 10 seconds after the last operation or by pressing [L/O].

Function Mode

Press [FUNC] to go to Function Mode and display the modulation, the attenuator and IF Exchange.

Restart Searching

This function is used to clear the search result and search again.

You can restart searching by pressing [FUNC] + [L/O].

The scanner also restarts searching if you change any parameter or search mode.

In Hold Mode, the scanner searches a search range only once.

Search Setting Parameters

Center Frequency

This parameter is the center frequency of the search range.

*Please see: [Band Coverage](#) for acceptable frequencies.

When you go to Band Scope Mode from another mode with a frequency, the scanner sets that frequency as the center frequency.

Span

This parameter is the span of the search range.

You can select from 0.2 / 0.4 / 0.6 / 0.8 / 1 / 2 / 4 / 6 / 8 / 10 / 20 / 40 / 60 / 80 / 100 / 120 / 140 / 160 / 180 / 200 / 250 / 300 / 350 / 400 / 450 / 500 (MHz).

Search Step

You can change the search step to find a transmission.

The search time changes depending on the search step size.

You can select from 5 / 6.25 / 7.5 / 8.33 / 10 / 12.5 / 15 / 20 / 25 / 50 / 100 (kHz).

Modulation

Modulation can be selected from AUTO / AM / NFM / FM / WFM / FMB.

This parameter is used in HOLD Mode.

When you go to Band Scope Mode from another mode with a frequency, the scanner sets the other mode's modulation as Band Scope Mode's modulation.

Key Operation during Band Scope Mode

Normal Mode during Normal Screen

[Scroll Control] Knob

Sets the level in Volume / Squelch Level Control mode.

Turn this knob, the marker changes the frequency every step.

[Scan / srch] Key

Press this key to go to Scan Mode.

[Hold /] Key

In Search or Max Hold Search Mode, press this key to go to Hold Mode.

In Hold Mode, press this key to return to the previous search mode.

[· / no / pri] Key

Press this key to display a setting screen.

[E / yes / gps] Key

Press this key to register the marker frequency as the center frequency.

[Menu] Key

Press this key to enter the Menu Mode.

Normal Mode during Setting Screen

[Scroll Control] Knob

Sets the level in Volume / Squelch Level Control mode.

Turn this knob to change the selected item parameter except “CF” item.

[Scan / srch] Key

Press this key to go to Scan Mode.

[Hold /] Key

In Search or Max Hold Search Mode, press this key to go to Hold Mode.

In Hold Mode, press this key to return to the previous search mode.

[· / no / pri] Key

Press this key to select the next setting item.

[E / yes / gps] Key

When the “CF” item is selected, press this key to go to the edit menu for the center frequency.

[Menu] Key

Press this key to enter the Menu Mode.

Function Mode

[Scroll Control] Knob

Sets the level in Volume / Squelch Level Control mode.

Turn this knob, the marker changes the frequency every bar.

[Scan / srch] Key

Press this key in Search Mode to go to Max Hold Search Mode.

Press this key in Max Hold Search Mode to go to Search Mode.

In Hold Mode, press this key to restart searching.

[Hold / ] Key

Press this key to toggle Close Call functions.

Long press this key to start Close Call Only Mode.

[L/O] Key

Press this key to restart searching.

[1 - 3 / sr1 - 3] Key

Press this key to start Service Search, Custom Search, Tone-Out Mode or Band Scope Mode in Set Search Key.

[4 / LEFT / ifx] Key

In Hold Mode, press this key to exchange IF(intermediate frequency).

[7 / att] key

Press this key to toggle the attenuator state for the search range.

Long press this key to toggle global attenuator.

[9 / mod] Key

Press this key to change the modulation.

[0 / wx] Key

Press this key to change WX Alert Priority Mode.

Long press this key to start WX Scan.

[E / yes / gps] Key

Press this key to change to the GPS Mode.

[Menu] Key

Press this key to enter the Menu Mode.

WIRED CLONE MODE

You can clone almost all the data of one scanner to another.

After connecting the two scanners, turn on the two scanners. Then select "Master" or "Slave" Wired Clone.

Confirm State

First, you select Master or Slave.

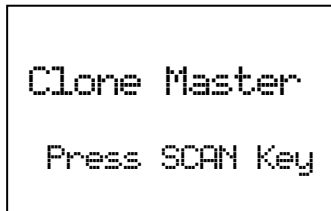

Master Unit

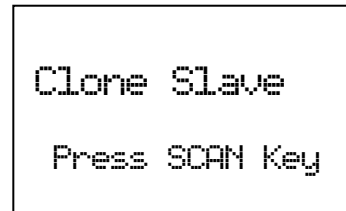

Slave Unit

Press [Scan / srch] on the Slave Unit, then on the Master Unit. The Master Unit checks whether the Slave Unit is connected correctly. When the Master Unit receives an acceptable response from the Slave Unit, the data transfer is started from the Master Unit to the Slave Unit. If the Master Unit doesn't receive an acceptable response in 10 second, it fails with an error.

Press [L/O] to return to Menu Mode at Wired Clone.

In the Slave Unit, when [Scan / srch] key is pressed and the display is "Clone Slave Waiting Data", the only control that will work is [🔌 / ⏻ / 🔑] for turning off the scanner and turning on the backlight.

Transferring State

During the data transfer, the scanners display a progress message. ("=" shows progressing transfer.)

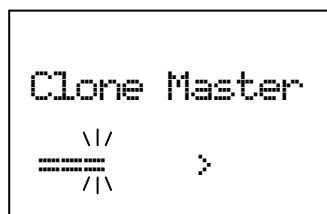

Master Unit

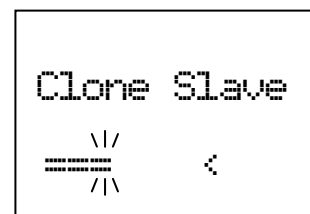

Slave Unit

Complete State

When the data transfer is completed, the scanners display "Complete".

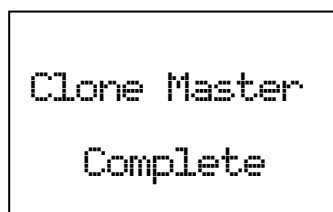

Master Unit

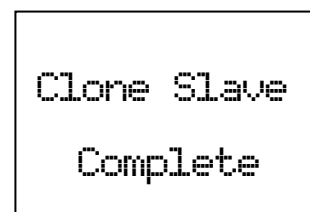

Slave Unit

Press [L/O] on the Master Unit to return to Confirm State.

When you reboot the Slave Unit, it has the new cloned data.

Note: When you reboots the Slave Unit, the Unit will check and erase the protected systems first, this process may take a few minutes which depend on the how many protected systems there are.

Error State

If the data transfer is not successful, the "Error" message appears.

Press [L/O] to return to Confirm State. Or power off the scanner.

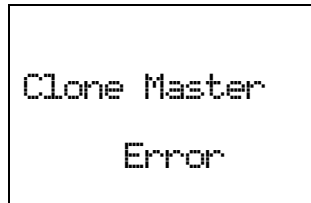

Master Unit

Note: The Slave Unit does not have an Error State. Even if the Slave Unit receives invalid data, it continues waiting for valid data.

Key Operation During Clone Mode



Confirm State

[Scan / srch] key : The scanner start data transfer.

[Menu] key : The scanner goes to Menu at Wired Clone



[FUNC] + [Menu] key : The scanner goes to Menu at Wired Clone

[L/O] key : The scanner goes to Menu at Wired Clone

[ /  / 



Another State

[L/O] key : The scanner goes back Confirm state. (Master Unit)





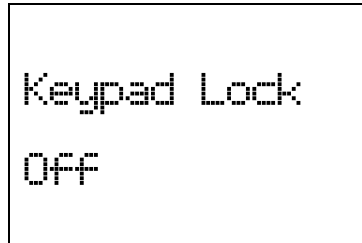
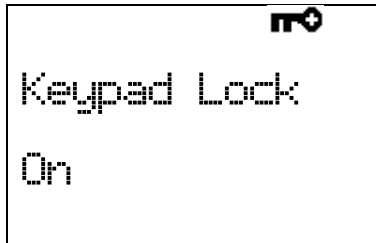

[ /  / 

Note: If you turn off the Slave scanner before cloning completes, memory is cleared when you turn the scanner back on.

KEYLOCK

Press [Func] + [ /  / 



While the keypad is locked, any key operation other than [Hold / ], [ /  / ], [Func] and turning [Scroll Control] key are invalid. (Of course, [Func] + [ /  / 

Pressing any other key causes the scanner displays "Keypad Lock" and "On" and does not sound any beep.



KEY SAFE MODE

This mode prevents accidentally changing parameter or modes. This mode is for handing the scanner to someone unfamiliar with its operation.

Some keys don't work in this mode.

Changed Key Operation in Key Safe Mode

The key in which a setting is applied showed in the following table.

		Scan	Service Search	Custom Search	Quick Search	WX	Close Call	Tone-Out	GPS	Band Scope
Normal Mode	Scan / srch		O ^{*1}	O ^{*1}	O ^{*1}	O	O	O	O	O
	Hold / 						O			
	L/O	O ^{*2}	O ^{*2}	O ^{*2}	O ^{*2}		O ^{*2,4}		O ^{*2}	
	1 - 3 / sr1 - 3									
	4 / LEFT / ifx									
	5 / lvl									
	6/RIGHT/ disp									
	7 / att									
	8 / rev									
	9 / mod									
	0 / wx									
	. / no / pri									
	E / yes / gps	O	O	O	O	O	O	O	O	O
Menu	O	O	O	O	O	O	O	O	O	
Function Mode	Scan / srch	O				O	O	O	O	
	Hold / 	O ^{*4}	O ^{*4}	O ^{*4}	O ^{*4}	O ^{*4}	O ^{*4}	O ^{*4}		O ^{*4}
	L/O		O	O	O		O			
	1 - 3 / sr1 - 3	O ^{*5}	O	O	O	O	O	O		O
	4 / LEFT / ifx	O ^{*5}	O ^{*3}	O ^{*3}	O ^{*3}	O ^{*3}	O ^{*3}	O		O
	5 / lvl	O ^{*5}								
	6/RIGHT/ disp									
	7 / att	O ^{*5}	O	O	O	O	O	O		O
	8 / rev									
	9 / mod	O ^{*5}	O	O	O		O	O		O
	0 / wx	O ^{*4.5}	O ^{*4}	O ^{*4}	O ^{*4}	O	O ^{*4}	O ^{*4}		O ^{*4}
	. / no / pri									
	E / yes / gps	O	O	O	O	O	O	O	O	O
Menu	O	O	O	O	O	O	O	O	O	

*1 This key works as RESUME key in search hold mode.

*2 You can control temporary L/O and unlock permanent L/O.

*3 This function is applied in hold mode or monitoring a transmission.

*4 Long press of this key does not work.

*5 This function is applied only in hold mode.

Key Safe Operation

Turns on power supply while pressing and holding [FUNC] key to go to the LAST MODE* in Key Safe Mode.

The scanner displays the “Key Safe Mode On” message after displaying the copyright message.

In Key Safe Mode, the on power supply while pressing and holding [FUNC] key to return to LAST MODE* in Full Operation. The scanner displays the “Key Safe Mode Off” message after displaying the copyright message.

If you try to set this function and Startup Key Operation together by pressing and holding [FUNC] key and the number key, the scanner does not set Key Safe Operation.

LAST MODE means the mode when the scanner is turned off. It resumes Scan Mode, Custom/Service/Quick Search Mode, Weather Mode, Close Call Only, Tone-Out Mode, each Hold Mode, GPS Mode and Band Scope Mode for LAST MODE.

In ID Search Hold Mode if ID has already been registered, LAST MODE will be ID Search Hold Mode. If ID has not been registered yet, LAST MODE will be Scan Mode.

Review Location Mode is set to normal Scanner Mode (not GPS Mode).

Key Safe Message

If you try to change a parameter or change to another mode, the scanner displays the following message and sounds an Error Tone.



```
Key Safe Mode  
Press FUNC while  
Power On for  
Full Operation
```

MEMORY INITIALIZATION

Press and hold [2 / sr 2], [9 / mod] and [Hold / 

The scanner clears all data and returns to initial setting. The display is as follows.

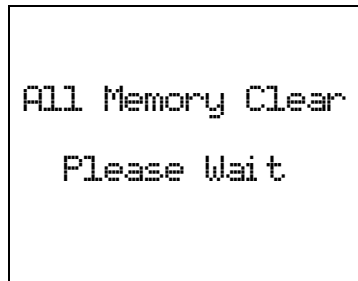

```
All Memory Clear
Please Wait
```

*If you unplug the AC Adapter or turn off the scanner during initialization, the scanner starts initializing again at next power on.

After clearing data, the scanner displays "Restore Preprogram List? Yes = "E" / No = "." " then you can select whether to restore the Preprogram List.

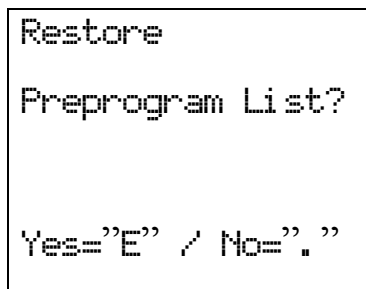

```
Restore
Preprogram List?

Yes="E" / No="."
```

Press [E / yes / gps] to restore the Preprogram List. Or, pressing [/ no / pri] to use without restoring the Preprogram List.

Then other keys are invalid and do not ring Key Beep.

If you press [E / yes / gps], the display is as follows.

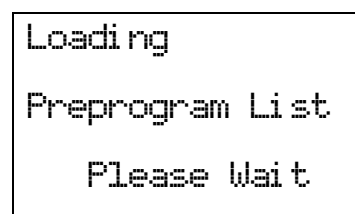

```
Loading
Preprogram List
Please Wait
```

BATTERY CHARGE

Battery Type Select

You can power the scanner non-rechargeable batteries (not supplied), nickel metal hydride (Ni-MH) rechargeable batteries or AC adapter.

You need to select the battery type before using batteries.

Turn off the scanner and remove the battery compartment cover. There is a switch to select the battery type like the following figure.

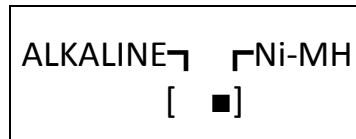

Set the switch to " Ni-MH " only if you are using Ni-MH batteries.

Set the switch to " ALKALINE " if you are using non-rechargeable batteries.

The scanner has a built-in circuit that charges the Ni-MH batteries.

To charge the batteries, connect the AC adapter to the scanner's power jack after installing the Ni-MH batteries with correct setting of the battery type switch.

The scanner charges the installed Ni-MH batteries. You can change the charging time.(See: [Set Charge Time](#))

*Never use non-rechargeable batteries in the scanner with the switch set to Ni-MH.

Charging the Battery

If an AC adapter is connected to the scanner, or a battery is installed to the scanner when an AC adapter is connected, the scanner will check the battery condition.

When the scanner is turned off:

If the battery is a rechargeable one, the scanner charges the battery.

The scanner displays "Normal Charging" while charging the battery.

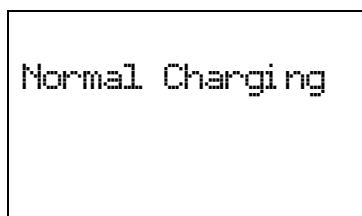

When the scanner charges the battery, it steps up the voltage gradually.

The scanner displays "Pre-Charging". "Pre-Charging" is a transition to the beginning of "Normal Charging".

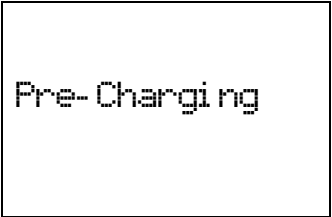

When the charge time elapses, it displays "Charge Complete".



If a battery is not installed, it displays "No Battery".



If the scanner detects that the battery cannot be charged, it displays "Battery Error".

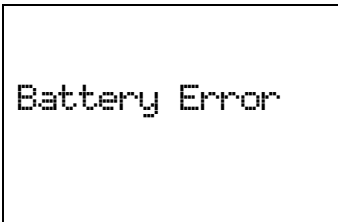

If there is a battery and Battery Type of the scanner is set to ALKALINE, it displays "Charge Off".

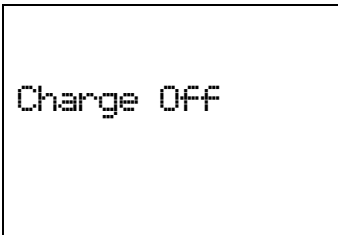

If the scanner detects an illegal voltage (voltage outside the allowable range), it displays “Illegal Voltage” and you cannot turn on power.

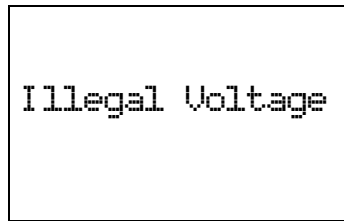

When the scanner is turned on:

If the battery is good, the scanner charges the battery and it operates ordinarily. When the scanner cannot judge the battery to be a good one at once, the scanner checks the battery and the battery icon is displayed.

If the scanner judges the battery good, the scanner starts charging and the battery icon disappears.

If it cannot regard the battery as good within 60 seconds, the scanner stops checking and the battery icon blinks.

OTHERS

AVAILABLE SYSTEM SETTINGS

Different types of systems and sites have different settings available.

*In the following table, "CNV" means Conventional System.

System Settings

System Settings	CNV*	P25		MOT	EDACS		LTR
		Standard Trunk	One-Freq Trunk		WIDE / NARROW	SCAT	
Edit Name	0	0	0	0	0	0	0
Edit Sys Option	0	0	0	0	0	0	0
Edit Site	---	0	0	0	0	0	0
Edit Group	0	0	0	0	0	---	0
Copy System	0	0	0	0	0	0	0
Delete System	0	0	0	0	0	0	0

System Option Settings

System Option Settings	CNV*	P25		MOT	EDACS		LTR
		Standard Trunk	One-Freq Trunk		WIDE / NARROW	SCAT	
Set Quick Key	0	---	---	---	---	---	---
Set Startup Key	0	---	---	---	---	---	---
Set Number tag	0	0	0	0	0	0	0
Set Lockout	0	---	---	---	---	---	---
Set Hold Time	0	---	---	---	---	---	---
ID Scan/Search	---	0	0	0	0	---	0
Set Delay Time	0	0	0	0	0	0	0
Edit Fleet Map	---	---	---	0	---	---	---
Priority ID Scan	---	0	---	0	0	---	0
Set Status Bit	---	---	---	0	---	---	---
Set End Code	---	---	---	0	---	---	---
Emergency Alert	---	---	---	0	0	---	---
Set ID Format (DEC/HEX)	---	0	0	0	---	---	---
Set ID Format (AFS/DEC)	---	---	---	---	0	---	---
Rvw ID:Srch L/O	---	0	0	0	0	---	0
Clr All L/O IDs	---	0	0	0	0	---	0
Set Audio AGC	0	0	0	0	0	0	0
P25 Waiting Time	0	---	---	---	---	---	---
P25 NAC Option	---	---	0	---	---	---	---

Site Settings

Site Setting	P25		MOT	EDACS		LTR
	Standard Trunk	One-Freq Trunk		WIDE / NARROW	SCAT	
Edit Name	0	0	0	0	---	0
Set Quick Key	0	0	0	0	0	0
Set Startup Key	0	0	0	0	0	0
Edit Band Plan (P25)	0	---	---	---	---	---
Edit Band Plan (Mot)	---	---	0	---	---	---
Set Site Type	---	---	---	0	---	---
Set Frequencies	0	0	0	0	0	0
Set Modulation	---	---	0	0	0	0
Set Attenuator	0	0	0	0	0	0
Set Lockout	0	0	0	0	0	0
Set Hold Time	0	0	0	0	0	0
Set C-Ch Only	---	---	0	---	---	---
Set LocationInfo	0	0	0	0	0	0
P25 Waiting Time	---	---	0	---	---	---
Delete Site	0	0	0	0	---	0
New Site	0	0	0	0	---	0

Site Frequency Settings

Site Frequency	P25		MOT	EDACS		LTR
	Standard Trunk	One-Freq Trunk		WIDE / NARROW	SCAT	
Edit Frequency	0	0	0	0	0	0
Input LCN	---	---	---	0	---	0
Set Number tag	---	---	---	---	0	---
Set Lockout	0	0	0	0	0	0
Volume Offset	---	---	---	---	0	---
Delete Frequency	0	0	0	0	0	0
New Frequency	0	0	0	0	0	0

Channel Settings

Channel Settings	CNV*	P25		MOT	EDACS		LTR
		Standard Trunk	One-Freq Trunk		WIDE / NARROW	SCAT	
Edit Name	0	0	0	0	0	---	0
Edit Frequency	0	---	---	---	---	---	---
Edit TGID	---	0	0	0	0	---	0
Set Audio Type	0	---	---	0	---	---	---
Set Number tag	0	0	0	0	0	---	0
Set Modulation	0	---	---	---	---	---	---
Set Attenuator	0	---	---	---	---	---	---
Set Priority	0	0	---	0	0	---	0
Set Alert	0	0	0	0	0	---	0
Set Lockout	0	0	0	0	0	---	0
Volume Offset	0	0	0	0	0	---	0
Copy Channel	0	0	0	0	0	---	0
Delete Channel	0	0	0	0	0	---	0
New Channel	0	0	0	0	0	---	0

TGID FORMAT FOR TRUNKED SYSTEM

[MOTOROLA TYPE1 SYSTEM]

Display Format

- | | |
|-----------|--|
| 1) BFF-SS | Normal ID
B is 1 digit
FF is 2 digits (0 filling)
SS is 1-2 digit(s) |
| 2) BFFF-S | Normal ID (when FLEET is 100-127)
B is 1 digit
FFF is 3 digits
S is 1 digit |
| 3) B----- | Partial ID (free FLEET and SUB-FLEET)
B is 1 digit |
| 4) BFF--- | Partial ID (free SUB-FLEET)
B is 1 digit
FF is 2 digits (0 filling) |
| 5) BFFF-- | Partial ID (free SUB-FLEET when FLEET is 100-127)
B is 1 digit
FFF is 3 digits |
| 6) NNNNN | Normal ID when SIZE CODE is 0
N is 1-5 digit(s) |
| 7) iNNNNN | I-CALL ID
N is 5 digits (0 filling) |

Input Format

- | | |
|-----------|---|
| 1) BFF-SS | Normal ID
B is 1 digit
FF should be 2 digits (0 filling)
SS is 1-2 digit(s) |
| 2) BFFF-S | Normal ID (when FLEET is 100-127)
B is 1 digit
FFF is 3 digits
S is 1 digit |
| 3) B- | Partial ID (free FLEET and SUB-FLEET)
B is 1 digit |
| 4) BFF- | Partial ID (fleet SUB-FLEET)
B is 1 digit
FF should be 2 digits (0 filling) |
| 5) BFFF- | Partial ID (fleet SUB-FLEET when FLEET is 100-127)
B is 1 digit
FFF is 3 digits |
| 6) NNNNN | Normal ID when SIZE CODE is 0
N is 1-5 digit(s) |
| 7) iNNNNN | I-CALL ID
N is 1-5 digit(s) |

Range

B : BLOCK (0-7)
FF(F) : FLEET
S(S) : SUB-FLEET

FLEET and SUB-FLEET maximum numbers depend on the SIZE CODE of each BLOCK in FLEET-MAP setting.

SIZE CODE 0:BLOCK0 : NNNNN (0- 8191)
BLOCK1 : NNNNN (8192-16383)
BLOCK2 : NNNNN (16384-24575)
BLOCK3 : NNNNN (24576-32767)
BLOCK4 : NNNNN (32768-40959)
BLOCK5 : NNNNN (40960-49151)
BLOCK6 : NNNNN (49152-57343)
BLOCK7 : NNNNN (57344-65535)
SIZE CODE 1 : FLEET (00-127) SUB-FLEET (0-3)
SIZE CODE 2 : FLEET (00-15) SUB-FLEET (0-7)
SIZE CODE 3 : FLEET (00-07) SUB-FLEET (0-7)
SIZE CODE 4 : FLEET (00) SUB-FLEET (0-15)
SIZE CODE 5 : FLEET (00-63) SUB-FLEET (0-3)
SIZE CODE 6 : FLEET (00-31) SUB-FLEET (0-7)
SIZE CODE 7 : FLEET (00-31) SUB-FLEET (0-3)
SIZE CODE 8 : FLEET (00-15) SUB-FLEET (0-3)
SIZE CODE 9 : FLEET (00-07) SUB-FLEET (0-3)
SIZE CODE 10 : FLEET (00-03) SUB-FLEET (0-7)
SIZE CODE 11 : FLEET (00-01) SUB-FLEET (0-15)
SIZE CODE 12 : FLEET (00) SUB-FLEET (0-15)
SIZE CODE 13 : FLEET (00) SUB-FLEET (0-15)
SIZE CODE 14 : FLEET (00) SUB-FLEET (0-15)

I-CALL ID : i00000-i65535

Note

The display format is also valid in remote command input.

[MOTOROLA TYPE2 SYSTEM]

<Decimal Format>

Display Format

- | | |
|-----------|-------------------------------|
| 1) NNNNN | Normal ID |
| | NNNNN is 1-5 digit(s) |
| 2) iNNNNN | I-CALL ID |
| | NNNNN is 5 digits (0 filling) |

Input Format

- | | |
|-----------|-----------------------|
| 1) NNNNN | Normal ID |
| | NNNNN is 1-5 digit(s) |
| 2) iNNNNN | I-CALL ID |
| | NNNNN is 1-5 digits. |

Range

Normal ID : 1-65535
I-CALL ID : i00000-i65535

Note

TYPE2 format cannot support PARTIAL ID.

<Hexadecimal Format>

Display Format

- | | |
|-----------|------------------------------|
| 1) NNNh | Normal ID |
| | NNN is 1-3 digit(s) |
| 2) iNNNNh | I-CALL ID |
| | NNNN is 4 digits (0 filling) |

Input Format

- | | |
|----------|---------------------|
| 1) NNN | Normal ID |
| | NNN is 1-3 digit(s) |
| 2) iNNNN | I-CALL ID |
| | NNNN is 1-4 digits. |

Range

Normal ID : 001 – FFF
I-CALL ID : i0000 – iFFFF

Note

TYPE2 format cannot support PARTIAL ID.
Normal ID: Hexadecimal Format omits lower 4 bit
Ex)

001h (Hex) -> 0016 (Dec)

[MOTOROLA P25 SYSTEM]

<Decimal Format>

Display Format

- | | | |
|--------------|-----------|----------------------------------|
| 1) NNNNN | Normal ID | NNNNN is 1-5 digit(s) |
| 2) iNNNNNNNN | I-CALL ID | NNNNNNNN is 8 digits (0 filling) |

Input Format

- | | | |
|--------------|-----------|-------------------------|
| 1) NNNNN | Normal ID | NNNNN is 1-5 digit(s) |
| 2) iNNNNNNNN | I-CALL ID | NNNNNNNN is 1-8 digits. |

Range

Normal ID : 1-65535
I-CALL ID : i00000-i16777215

Note

P25 format cannot support PARTIAL ID.

<Hexadecimal Format>

Display Format

- | | | |
|------------|-----------|--------------------------------|
| 1) NNNN | Normal ID | NNNN is 1-4 digit(s) |
| 2) iNNNNNN | I-CALL ID | NNNNNN is 6 digits (0 filling) |

Input Format

- | | | |
|------------|--------------------------------|-----------------------|
| 1) NNNN | Normal ID (Hexadecimal Format) | NNNN is 1-4 digit(s) |
| 2) iNNNNNN | I-CALL ID | NNNNNN is 1-6 digits. |

Range

Normal ID : 0001 – FFFF
I-CALL ID : i000000 – iFFFFFF

Note

P25 format cannot support PARTIAL ID.

[EDACS SYSTEM]

<AFS format>

Display Format

- | | |
|--|-----------------------------|
| 1) AA-FFS | Normal ID |
| | AA is 2 digits (0 filling) |
| | FF is 2 digits (0 filling) |
| | S is 1 digit |
| 2) AA----Partial ID (free FLEET and SUB-FLEET) | |
| | AA is 2 digits (0 filling) |
| 3) AA-FF- | Partial ID (free SUB-FLEET) |
| | AA is 2 digits (0 filling) |
| | FF is 2 digits (0 filling) |

Input Format

- | | |
|-----------|---------------------------------------|
| 1) AA-FFS | Normal ID |
| | AA should be 2 digits (0 filling) |
| | FF should be 2 digits (0 filling) |
| | S should be 1 digit |
| 2) AA- | Partial ID (free FLEET and SUB-FLEET) |
| | AA should be 2 digits (0 filling) |
| 3) AA-FF | Partial ID (free SUB-FLEET) |
| | AA should be 2 digits (0 filling) |
| | FF should be 2 digits (0 filling) |

Range

- | | |
|---------------|---------------------------|
| AA : AGENCY | 2digits (00-15) |
| FF : FLEET | 2digits (00-15) |
| S : SUB-FLEET | 1digit (0-7) |
| | *ALLO(00-00-0) is invalid |

Note

- Both AFS and Decimal Format are valid to input regardless of AFS setting.
- Display Format depends on AFS/Decimal setting except for I-CALL ID.
- Use Decimal format when I-CALL is needed.
- I-CALL format is always shown in Decimal Format regardless of AFS setting.
- AFS format cannot support I-CALL ID format.
- Display Format is also valid in remote command input.

<Decimal format>

Display Format

- | | |
|-----------|-------------------------------------|
| 1) NNNN | Normal ID |
| | NNNN is 1-4 digit(s) (no 0 filling) |
| 2) iNNNNN | I-CALL ID |
| | NNNNN is 5 digits (0 filling) |

Input Format

- | | |
|-----------|-----------------------|
| 1) NNNN | Normal ID |
| | NNNN is 1-4 digit(s) |
| 2) iNNNNN | I-CALL ID |
| | NNNNN is 1-5 digit(s) |

Range

Normal ID : 1-2047
I-CALL ID : i00000-i16383

Note

- Both AFS and Decimal Format are valid to input regardless of AFS setting.
- Display Format depends on AFS/Decimal Setting except for I-CALL ID.
- I-CALL format is always showed as Decimal Format regardless of AFS setting.
- Decimal format cannot support Partial ID.

[LTR SYSTEM]

Display Format

- 1) A-RR-NNN Normal ID
 A is 1 digit
 RR is 2 digits
 NNN is 3 digits
- 2) A-RR---- Partial ID
 A is 1 digit
 RR is 2 digits

Input Format

- 1) A-RR-NNN Normal ID
 A is 1 digit
 RR is 2 digits
 NNN is 3 digits
- 2) ARRNNN Normal ID (Easy Way)
 A is 1 digit
 RR should be 2 digits (01-20)
 NNN should be 3 digits (000-254)
- 3) A-RR Partial ID (free ID)
 A is 1 digit
 RR should be 2 digits (01-20)

Range

- A : AREA CODE 1digit (0 or 1)
- RR : HOME REPEATER 2digit (01-20)
- NNN : ID 3digit (000-254)

Note

LTR System has no I-CALL ID.

FLEET MAP

The range of TGIDs is from 0 to 65535. This range is split into 8 equal blocks, and each Block is set to one of 15 Size Codes.

The range of TGID	0 - 65535
Block 0	0 - 8191
Block 1	8192 - 16383
Block 2	16384 - 24575
Block 3	24576 - 32767
Block 4	32768 - 40959
Block 5	40960 - 49151
Block 6	49152 - 57343
Block 7	57344 - 65535

Size Code from 0 to 11 uses 1 Block, 12+ occupies multiple blocks.

"**Size Code 12**" occupies 2 Blocks and this can be set to even Block numbers. If you try to set this to an odd Block number, it is set to the previous Block number.

The Block after the one you set to "Size Code 12" is also treated as "Size Code 12". This number does not appear in the Block selection.

For example, if you try to set Size Code 12 to Block 3, it is set to Block 2. Then the Block 3 is skipped because Block 2 is set to "Size Code 12". Block 2 and Block 3 are treated as "Size Code 12". Then the scanner advances to Block 4 to select its Size Code.

"**Size Code 13**" occupies 4 Blocks and this can be set only for Block 0 or Block 4. If you try to set this to Block number 1 - 3, it is set to Block 0. And if you try to set this to Block number 5 - 7, it is set to Block 4.

When you set a block to "Size Code 13", the following three blocks are also be treated as "Size Code 13".

The "**Size Code 14**" occupies all 8 Blocks. So, this Size Code can only be set for Block 0. If you try to set this to another Block, it is set to Block 0. Then only the Block 0 is displayed. All Blocks are treated as "Size Code 14".

If you change a Size Code from these 3 Codes to a Size Code which occupies a fewer number of Block, the scanner sets the other Blocks to "Size Code 0".

For example, if you changes the Block 0 from "Size Code 13" to "Size Code 5", the setting of Blocks are: Block 0 = Size Code 5, Block 1 - 3 = Size Code 0.

Details of each Size Code are as follows.

Size Code	Fleet-SubFleet-ID	Number of Blocks occupied
0	(as Type II ID)	1
1	128-4-16	1
2	16-8-64	1
3	8-8-128	1
4	1-16-512	1
5	64-4-32	1
6	32-8-32	1
7	32-4-64	1
8	16-4-128	1
9	8-4-256	1
10	4-8-256	1
11	2-16-256	1
12	1-16-1024	2
13	1-16-2048	4
14	1-16-4096	8

*The numbers of "Fleet-SubFleet-ID" means the number of each. If the number of Fleets is 4, there are 4 Fleets and the range is from 0 to 3.

PRESET FLEET MAPS

*The numbers in the table shows the number of SIZE CODE.

BLOCK No.	0	1	2	3	4	5	6	7
Preset 1	11	11	11	11	11	11	11	11
Preset 2	4	4	4	4	4	4	4	4
Preset 3	4	4	4	4	4	4	12	(12)
Preset 4	12	(12)	4	4	4	4	4	4
Preset 5	4	4	12	(12)	4	4	4	4
Preset 6	3	10	4	4	12	(12)	12	(12)
Preset 7	10	10	11	4	4	4	4	4
Preset 8	1	1	2	2	3	3	4	4
Preset 9	4	4	0	0	0	0	0	0
Preset 10	0	0	0	0	0	0	4	4
Preset 11	4	0	0	0	0	0	0	0
Preset 12	0	0	0	0	0	0	0	4
Preset 13	3	3	11	4	4	0	0	0
Preset 14	4	3	10	4	4	4	12	(12)
Preset 15	4	4	4	11	11	0	12	(12)
Preset 16	3	10	10	11	0	0	12	(12)

WEATHER CHANNELS

The modulation for all Weather Channels is FM.

CH No.	Frequency
1	162.5500 MHz
2	162.4000 MHz
3	162.4750 MHz
4	162.4250 MHz
5	162.4500 MHz
6	162.5000 MHz
7	162.5250 MHz
8	161.6500 MHz
9	161.7750 MHz
10	163.2750 MHz

CTCSS FREQUENCY

The scanner can detect the following 50 CTCSS frequencies.

67.0Hz	88.5Hz	114.8Hz	151.4Hz	177.3Hz	203.5Hz	250.3Hz
69.3Hz	91.5Hz	118.8Hz	156.7Hz	179.9Hz	206.5Hz	254.1Hz
71.9Hz	94.8Hz	123.0Hz	159.8Hz	183.5Hz	210.7Hz	
74.4Hz	97.4Hz	127.3Hz	162.2Hz	186.2Hz	218.1Hz	
77.0Hz	100.0Hz	131.8Hz	165.5Hz	189.9Hz	225.7Hz	
79.7Hz	103.5Hz	136.5Hz	167.9Hz	192.8Hz	229.1Hz	
82.5Hz	107.2Hz	141.3Hz	171.3Hz	196.6Hz	233.6Hz	
85.4Hz	110.9Hz	146.2Hz	173.8Hz	199.5Hz	241.8Hz	

DCS CODE

The scanner can detect the following 104 hexadecimal DCS codes.

023	051	114	143	174	245	266	332	411	452	506	612	703
025	053	115	145	205	246	271	343	412	454	516	624	712
026	054	116	152	212	251	274	346	413	455	523	627	723
031	065	122	155	223	252	306	351	423	462	526	631	731
032	071	125	156	225	255	311	356	431	464	532	632	732
036	072	131	162	226	261	315	364	432	465	546	654	734
043	073	132	165	243	263	325	365	445	466	565	662	743
047	074	134	172	244	265	331	371	446	503	606	664	754

CEA2009-SAME EVENT CODE(ANSI/CEA-2009-A October 2005)

Standard	Event Code	EVENT LEVEL			LCD Display
		Warning			
		Watch	Advisory		
ADR	Administrative Message			O	Admin Message
AVA	Avalanche Watch		O		Avalanche
AVW	Avalanche Warning	O			Avalanche
BHW	Biological Hazard Warning	O			Biological
BWW	Boil Water Warning	O			Boil Water
BZW	Blizzard Warning	O			Blizzard
CAE	Child Abduction Emergency			O	Child Emergency
CDW	Civil Danger Warning	O			Civil Danger
CEM	Civil Emergency Message	O			Civil EMG
CFA	Coastal Flood Watch		O		Coastal Flood
CFW	Coastal Flood Warning	O			Coastal Flood
CHW	Chemical Hazard Warning	O			Chemical
CWW	Contaminated Water Warning	O			Contam. Water
DBA	Dam Watch		O		Dam Break
DBW	Dam Break Warning	O			Dam Break
DEW	Contagious Disease Warning	O			Contagious
DMO	Practice/Demo			O	System Demo
DSW	Dust Storm Warning	O			Dust Storm
EAN	Emergency Action Notification	O			EMG Notify
EAT	Emergency Action Termination			O	EMG Terminate
EQW	Earthquake Warning	O			Earthquake
EVA	Evacuation Watch		O		Evacuate Note
EVI	Immediate Evacuation	O			Evacuate Note
FCW	Food Contamination Warning	O			Food
FFA	Flash Flood Watch		O		Flash Flood
FFS	Flash Flood Statement			O	Flash Flood
FFW	Flash Flood Warning	O			Flash Flood
FLA	Flood Watch		O		Flood
FLS	Flood Statement			O	Flood
FLW	Flood Warning	O			Flood
FRW	Fire Warning	O			Fire
FSW	Flash Freeze Warning	O			Flash Freeze
FZW	Freeze Warning	O			Freeze
HLS	Hurricane Statement			O	Hurricane
HMW	Hazardous Material Warning	O			Hazardous
HUA	Hurricane Watch		O		Hurricane
HUW	Hurricane Warning	O			Hurricane
HWA	High Wind Watch		O		High Wind
HWW	High Wind Warning	O			High Wind
IBW	Iceberg Warning	O			Iceberg
IFW	Industrial Fire Warning	O			Industrial Fire
LAE	Local Area Emergency			O	Local EMG
LEW	Law Enforcement Warning	O			Law Enforcement

LSW	Land Slide Warning	O			Land Slide
NAT	National Audible Test			O	National Audible
NIC	National Information Center			O	National Info
NMN	Network Notification Message			O	Network Message
NPT	National Periodic Test			O	Nation Period
NST	National Silent Test			O	Nation Silent
NUW	Nuclear Power Plant Warning	O			Nuclear Plant
POS	Power Outage Advisory			O	Power Outage
RHW	Radiological Hazard Warning	O			Radiological
RMT	Required Monthly Test			O	Monthly
RWT	Required Weekly Test			O	Weekly
SMW	Special Marine Warning	O			Special Marine
SPS	Special Weather Statement			O	Special WX
SPW	Shelter In-Place Warning	O			Shelter
SVA	Severe Thunderstorm Watch		O		Thunderstorm
SVR	Severe Thunderstorm Warning	O			Thunderstorm
SVS	Severe Weather Statement			O	Severe WX
TOA	Tornado Watch		O		Tornado
TOE	911 Telephone Outage Emergency			O	911 Phone Outage
TOR	Tornado Warning	O			Tornado
TRA	Tropical Storm Watch		O		Tropical Storm
TRW	Tropical Storm Warning	O			Tropical Storm
TSA	Tsunami Watch		O		Tsunami
TSW	Tsunami Warning	O			Tsunami
TXB	Transmitter Backup On			O	TX Backup On
TXF	Transmitter Carrier Off			O	TX Carrier Off
TXO	Transmitter Carrier On			O	TX Carrier On
TXP	Transmitter Primary On			O	TX Primary On
VOW	Volcano Warning	O			Volcano
WFA	Wild Fire Watch		O		Wild Fire
WFW	Wild Fire Warning	O			Wild Fire
WSA	Winter Storm Watch		O		Winter Storm
WSW	Winter Storm Warning	O			Winter Storm
**A	Unrecognized Watch		O		Unrecognized
**E	Unrecognized Emergency			O	Unrecognized
**S	Unrecognized Statement			O	Unrecognized
**W	Unrecognized Warning	O			Unrecognized

REMOTE COMMAND

【 Remote Communication Format 】

BPS rate : 4800/9600/19200/38400/57600/115200 bps
Start/Stop bit : 1 bit, 1 bit
Data Length : 8 bit
Parity Check : None
Code : ASCII
Flow Control : None
Return Code : Carriage Return only

【 FORMAT OF THIS DOCUMENT 】

<COMMAND NAME>

Summary explanation of the function of the command

Controller → Radio

Command format

Radio → Controller

Response format

NOTE

1. Commands are required to wait a response from the scanner, then, next command is accepted.
2. All memory access commands are acceptable in only Program Mode.
Use PRG command to enter Program Mode, and EPG command to exit.
3. Error messages aren't described for each command, but the scanner returns error message to the controller as follows.
 - 1) Command format error / Value error : ERR[\r]
 - 2) The command is invalid at the time : NG[\r]
 - 3) Framing error : FER[\r]
 - 4) Overrun error : ORER[\r]
4. [\r] means "to hit the Enter key" or "to send the Return code".
5. Several commands or responses with long format are described like multi-line because of the page width but their formats are only single line, actually.
In set command, only "," parameters are not changed.
6. The set command is aborted if any format error is detected.
7. [INDEX] or [xxx_INDEX] is the index of internal memory chain.
Dynamic Memory Allocation Structure always uses it as a handle to access data and to trace forward/reverse or up/down index.
The range of the index is from 1 to maximum memory block (about 45000).
8. [FRQ], [BASEx] and [LIMIT_x] are frequency format.
It is showed by 8 digit number without decimal point.
The order of the digits is from 1 GHz digit to 100 Hz digit.
ex. 08510125 means 851.0125MHz
9. [TGID] shows TGID format. The formats depend on Trunked System Type.
See another Appendix to get further information.
10. [NAME] shows each custom name. If you set only a space character, the name will return to default name.
11. [LATITUDE] shows North or South Latitude.
The data shows "DDMMSSsL" at DMS Format.

DD	:	Degree	(00 - 90 : Double figure fixation)
MM	:	Minute	(00 - 59 : Double figure fixation)
SSss	:	Second	(SS : 00 - 59 : Double figure fixation) (ss : 00 - 99 : Double figure fixation)
L	:	Bearing	(N : North / S : South)

ex) "North Latitude 40°42'51.12" shows "40425112N".

12. [LONGITUDE] shows West or East Longitude.

The data shows “DDMMSSsL” at DMS Format.

DDD : Degree (000 - 180 : Triple figure fixation)
 MM : Minute (00 - 59 : Double figure fixation)
 SSss : Second (SS : 00 - 59 : Double figure fixation)
 (ss : 00 - 99 : Double figure fixation)
 L : Bearing (W : West / E : East)

ex) “West Longitude 74°00’23.05” shows “074002305W”.

Remote Command List

No.	Category	Command	Function	Program Mode Only
	Remote Control	GID	Get Current TalkGroup ID Status	
		KEY	Push KEY	
		POF	Power Off	
		QSH	Go to quick search hold mode	
		QSC	Set current frequency and get reception status	
		CSC	Go to Custom search and get reception status	
		PWR	Get RSSI Level	
		STS	Get Current Status	
		GLG	Get Reception Status	
		JPM	Jump Mode	
		JNT	Jump to Number Tag	
		MNU	Menu Mode	
		System Information	MDL	Get Model Info
	VER		Get Firmware Version	
	Program Control Mode	PRG	Enter Program Mode	
		EPG	Exit Program Mode	
	System Settings	BLT	Get/Set Backlight	0
		BSV	Get/Set Battery Info	0
		COM	Get/Set COM port setting	0
		CLR	Clear All Memory	0
		KBP	Get/Set Key Beep and setting	0
		OMS	Get/Set Opening Message	0
		PRI	Get/Set Priority Mode	0
		AGV	Get/Set Auto Gain Control	0
		SCT	Get System Count	0
	Scan Settings	SIH	Get System Index Head	0
		SIT	Get System Index Tail	0
		QSL	Get/Set System/Site Quick Lockout	0
		QGL	Get/Set Group Quick Lockout	0
		CSY	Create System	0
		DSY	Delete System	0
		SIN	Get/Set System Info	0
		TRN	Get/Set Trunk Info	0
		AST	Append Site	0
		SIF	Get/Set Site Info	0
		MCP	Get/Set Motorola Custom Band Plan	0
	ABP	Get/Set APCO-P25 Band Plan	0	

		TFQ	Get/Set Trunk Frequency Info	O
		AGC	Append Channel Group	O
		AGT	Append TalkGroup ID Group	O
		DGR	Delete Group / Site	O
		GIN	Get/Set Group Info	O
		ACC	Append Channel / Trunk Frequency	O
		ACT	Append TalkGroup ID	O
		DCH	Delete Channel	O
		CIN	Get/Set Channel Info	O
		TIN	Get/Set TalkGroup ID Info	O
		GLI	Get Lockout TalkGroup ID (for Rvw L/O ID)	O
		SLI	Get Search L/O TalkGroup ID	O
		ULI	Unlock TalkGroup ID (for Rvw L/O ID)	O
		LOI	Lockout ID (TalkGroup ID)	O
		REV	Get Rev Index	O
		FWD	Get Fwd Index	O
		RMB	Get Remains of Memory Block	O
		MEM	Get Memory Used	O
	Location Setting	LIH	Get Location Alert System Index Head	O
		LIT	Get Location Alert System Index Tail	O
		CLA	Create Location Alert System	O
		DLA	Delete Location Alert System	O
		LIN	Get/Set Location Alert System Info	O
	Search / Close Call Settings	SCO	Get/Set Search/Close Call Settings	O
		BBS	Get/Set Broadcast Screen Band Settings	O
		SHK	Get / Set Search Key Settings	O
		GLF	Get Global Lockout Freq	O
		ULF	Unlock Global L/O	O
		LOF	Lock Out Frequency	O
		CLC	Get/Set Close Call Settings	O
	Service Search Settings	SSP	Get/Set Service Search Settings	O
		CSG	Get/Set Custom Search Group	O
	Custom Search Settings	CBP	Get/Set C-Ch Only Custom search MOT Band Plan	O
		CSP	Get/Set Custom Search Settings	O
	Weather Settings	WXS	Get/Set Weather Settings	O
		SGP	Get/Set SAME Group Settings	O
	Tone-Out Setting	TON	Get/Set Tone-Out Settings	O
	LCD Contrast Settings	CNT	Get/Set LCD Contrast Settings	O
	Scanner Option Settings	SCN	Get/Set Scanner Option Settings	O
	Volume Level Settings	VOL	Get/Set Volume Level Settings	
	Squelch Level Settings	SQL	Get/Set Squelch Level Settings	
	APCO Data Settings	P25	Get/Set APCO Data Settings	
	Default Band Coverage Settings	DBC	Get/Set Default Band Coverage Settings	O
	GPS Settings	GDO	Get/Set GPS Format	O
	Band Scope Settings	BSP	Get/Set Band Scope Settings	O
		GIE	Get Global IF exchange Frequency	O
	IF exchange list Settings	CIE	Clear IF exchange Frequency	O
		RIE	Register IF exchange Frequency	O
	TEST	BAV	Get Battery Voltage	
		WIN	Get Window Voltage	

<COMMAND GID>

Get Current TGID Status

Controller → Radio

GID[\r]

Radio → Controller

GID, [SITE_TYPE], [TGID], [ID_SRCH_MODE], [NAME1], [NAME2], [NAME3] [\r]

[SITE_TYPE] : Site Type
CNV : CONVENTIONAL system site
MOT : MOTOROLA system site
EDC : EDACS Narrow / Wide system site
EDS : EDACS SCAT system site
LTR : LTR system site
P25S : P25 STANDARD system site
P25F : P25 One Frequency TRUNK system site

[TGID] : TGID
[ID_SRCH_MODE] : ID SCAN / ID SEARCH Mode
0:ID SCAN Mode / 1:ID SEARCH Mode)
[NAME1] : SYSTEM / SITE NAME (Alpha Tag)
[NAME2] : GROUP NAME (Alpha Tag)
[NAME3] : TGID NAME (Alpha Tag)

FUNCTION

This command return TGID currently displayed on LCD.

If you get the TGID once, the scanner returns , , , , , [\r] until next reception.

NOTE :

This command return , , , , , [\r], when TGID is not displayed.

<COMMAND KEY>

Push KEY

Controller → Radio

KEY, [KEY_CODE], [KEY_MODE] [\r]

Radio → Controller

KEY,OK[\r]

[KEY_CODE]	M	:	MENU
	F	:	FUNC
	H	:	HOLD
	S	:	SCAN/SEARCH
	L	:	L/O
	1	:	1
	2	:	2
	3	:	3
	4	:	4
	5	:	5
	6	:	6
	7	:	7
	8	:	8
	9	:	9
	0	:	0
	.	(dot)	: ./NO
	E	:	E/YES
	>	:	VFO RIGHT * Set "P" to KEY_MODE.
	<	:	VFO LEFT * Set "P" to KEY_MODE.
	^	:	VFO PUSH
	P	:	POWER/LIGHT/LOCK

[KEY_MODE]	P	:	Press
	L	:	Long Press
	H	:	Hold (Press and Hold until Release receive)
	R	:	Release (Cancel Hold state)

Ex.1) Press MENU KEY

→ KEY,M,P[\r]

← OK[\r]

Ex.2) Press F + SCAN KEY

→ KEY,F,P[\r] : Hold F KEY

← OK[\r]

→ KEY,S,P[\r] : Press SCAN KEY (F + SCAN KEY operation)

← OK[\r]

→ KEY,F,P[\r] : Release F KEY

→ OK[\r]

Ex.3) Press and Hold L/O KEY

→ KEY,L,L[\r]

← OK[\r]

The status of KEY HOLD does time-out in 10 seconds after having received the command of KEY HOLD when there is not communication. (For example, "KEY,F,H".)

<COMMAND POF>

Power OFF
Controller → Radio
POF[\r]
Radio → Controller
POF,OK[\r]

Turns off the scanner.
After this command, the scanner doesn't accept any command.

<COMMAND QSH>

Go to quick search hold mode
Controller → Radio
QSH, [FRQ], [RSV], [MOD], [ATT], [DLY], [RSV], [CODE_SRCH], [BSC], [REP], [RSV],
[AGC_ANALOG], [AGC_DIGITAL], [P25WAITING] [\r]
Radio → Controller
QSH,OK[\r] or QSH,NG[\r]

[FRQ]	:	Frequency (The right frequency)	
[MOD]	:	Modulation (AUTO/AM/FM/NFM/WFM/FMB)	
[ATT]	:	Attenuation (0:OFF / 1:ON)	
[DLY]	:	Delay Time (-10,-5,-2,0,1,2,5,10,30)	
[CODE_SRCH]	:	CTCSS/DCS/P25 NAC Search (0:OFF / 1: CTCSS/DCS / 2: P25 NAC Search)	
[BSC]	:	Broadcast Screen (16digit: #####.##)	
	(each # is 0 or 1)	*+ Band10	
	0 means OFF	:	
	1 means ON	+---- Band 2	
		+---- Band 1	
		+----- Reserve	
		+----- NOAA WX	
		+----- VHF TV	
		+----- UHF TV	
		+----- FM	
		+----- Pager	
[REP]	:	Repeater Find	(0:OFF / 1:ON)
[AGC_ANALOG]	:	AGC Setting for Analog Audio	(0:OFF / 1:ON)
[AGC_DIGITAL]	:	AGC Setting for Digital Audio	(0:OFF / 1:ON)
[P25WAITING]	:	P25 Waiting time	
		(0,100,200,300, , 900,1000)	
	0	: 0ms	
	100	: 100ms	
	200	: 200ms	
	300	: 300ms	
	400	: 400ms	
	500	: 500ms	
	600	: 600ms	
	700	: 700ms	
	800	: 800ms	
	900	: 900ms	
	1000	: 1000ms	

[RSV] : Reserve Parameter * This is always only ",".

This command is invalid when the scanner is in Menu Mode, during Direct Entry operation, during Quick Save operation.

FUNCTION

UASD specifies arbitrary frequency and changes to Quick Search Hold (VFO) mode.

Parameter, such as STP, changes the contents of Srch/CloCall option.

Note:

Even when only [FRQ] parameter is set, this command will work.

<COMMAND QSC>

Set current frequency and get reception status

Controller → Radio

QSC, [FRQ], [RSV], [MOD], [ATT], [DLY], [RSV], [CODE_SRCH], [BSC], [REP], [RSV], [AGC_ANALOG], [AGC_DIGITAL], [P25WAITING] [\r]

Radio → Controller

QSC, [RSSI], [FRQ], [SQL] [\r] or QSC, NG [\r]

- [FRQ] : Frequency (The right frequency)
- [MOD] : Modulation (AUTO/AM/FM/NFM/WFM/FMB)
- [ATT] : Attenuation (0:OFF / 1:ON)
- [DLY] : Delay Time (-10, -5, -2, 0, 1, 2, 5, 10, 30)
- [CODE_SRCH] : CTCSS/DCS Search
(0:OFF / 1: CTCSS/DCS Search / 2: P25 NAC Search)
- [BSC] : Broadcast Screen (16digit: #####.#)
 - (each # is 0 or 1) |||||+--- Band10
 - 0 means OFF ||||| :
 - 1 means ON |||||+---- Band 2
 - |||||+---- Band 1
 - ||||+----- Reserve
 - |||+----- NOAA WX
 - ||+----- VHF TV
 - |+----- UHF TV
 - +----- FM
 - +----- Pager
- [REP] : Repeater Find (0:OFF / 1:ON)
- [RSSI] : RSSI A/D Value (0-1023)
- [SQL] : Squelch Status (0:CLOSE / 1:OPEN)
- [AGC_ANALOG] : AGC Setting for Analog Audio(0:OFF / 1:ON)
- [AGC_DIGITAL] : AGC Setting for Digital Audio (0:OFF / 1:ON)
- [P25WAITING] : P25 Waiting time
(0,100,200,300, , 900,1000)
 - 0 : 0ms
 - 100 : 100ms
 - 200 : 200ms
 - 300 : 300ms
 - 400 : 400ms
 - 500 : 500ms
 - 600 : 600ms
 - 700 : 700ms
 - 800 : 800ms
 - 900 : 900ms
 - 1000 : 1000ms
- [RSV] : Reserve Parameter * This is always only ",".

This command is invalid when the scanner is in Menu Mode, during Direct Entry operation, during Quick Save operation.

FUNCTION

UASD specifies arbitrary frequency and changes to Quick Search Hold (VFO) mode.

Parameter, such as STP, changes the contents of Srch/CloCall option.

<COMMAND CSC>

Go to Custom search and get reception status

Controller → Radio

① CSC,ON[\r]

② CSC,OFF[\r]

Radio → Controller

① CSC, [RSSI], [FRQ], [SQL] [\r]

CSC, [RSSI], [FRQ], [SQL] [\r]

CSC, [RSSI], [FRQ], [SQL] [\r]

....

....

....

CSC, [RSSI], [FRQ], [SQL] [\r]

② CSC,OK[\r]

[RSSI] : RSSI A/D Value (0-1023)

[FRQ] : Current Frequency

[SQL] : Squelch Status (0:CLOSE / 1:OPEN)

This command outputs custom search status of each frequency sequentially.
Use CSC,OFF command to stop the output.

This command is invalid when the scanner is in Menu Mode, during Direct Entry operation, during Quick Save operation.

<COMMAND PWR>

*Get RSSI Level

Controller → Radio

PWR[\r]

Radio → Controller

PWR, [RSSI], [FRQ] [\r]

[RSSI] : RSSI A/D Value (0-1023)

[FRQ] : Current Frequency

Returns current RSSI level and its frequency.

The order of the frequency digits is from 1 GHz digit to 100 Hz digit.

<COMMAND STS>

Get Current Status
Controller → Radio

STS[\r]

Radio → Controller

STS, [DSP_FORM], [L1_CHAR], [L1_MODE], [L2_CHAR], [L2_MODE], [L3_CHAR], [L3_MODE],
[L4_CHAR], [L4_MODE], ..., [L8_CHAR], [L8_MODE], [SQL], [MUT], [BAT], [WAT], [RSV],
[RSV], [SIG_LVL], [BK_COLOR], [BK_DIMMER] [\r]

- [DSP_FORM] : Display Form (4 - 8digit:#####)
(each # is 0 or 1) 0 means Small Font / 1 means Large Font.
- [L1_CHAR] : Line1 Characters 16char (fixed length)
- [L1_MODE] : Line1 Display Mode 16char
- [L2_CHAR] : Line2 Characters 16char (fixed length)
- [L2_MODE] : Line2 Display Mode 16char
- [L3_CHAR] : Line3 Characters 16char (fixed length)
- [L3_MODE] : Line3 Display Mode 16char
- [L4_CHAR] : Line4 Characters 16char (fixed length)
- [L4_MODE] : Line4 Display Mode 16char
- :
- [L8_CHAR] : Line8 Characters 16char (fixed length)
- [L8_MODE] : Line8 Display Mode 16char
- [SQL] : Squelch Status (0:CLOSE / 1:OPEN)
- [MUT] : Mute Status (0:OFF / 1:ON)
- [RSV] : Reserve Parameter * This is always only "0".
- [BAT] : Battery Low Status (0:No Alert / 1:Alert)
- [WAT] : Weather Alert Status (0:No Alert / 1: Alert / \$\$\$: Alert
SAME CODE)
- [SIG_LVL] : Signal Level (0 - 5)
- [BK_COLOR] : Backlight Color
(OFF, BLUE, RED, MAGENTA, GREEN, CYAN, YELLOW, WHITE)
- [BK_DIMMER] : Backlight Dimmer (0:OFF / 1:Low / 2:Middle / 3:High)

NOTE :) Display Mode for Line1 - Line8
(space) : NORMAL CHAR, *: REVERSE CHAR
_ (Under bar) : Underline
If all 16chars are normal, only ", " is sent.

The number of [Lx_CHAR] and [Lx_MODE] depend on Display Form.

Ex.1)

```

┌──────────────────┐
│ -- M E N U -- │   Squelch Status      : OPEN
│ Program System │   Mute Status        : OFF
│ Program Location│   Battery Low Status  : No Alert
│ Srch/CloCall Opt│   Weather Alert Status : No Alert
└──────────────────┘
→ STS[\r]
← 1111,
    -- M E N U -- , ← [L1_CHAR]
    _____ , ← [L1_MODE]
    Program System , ← [L2_CHAR]
    ***** , ← [L2_MODE]
    Program Location, ← [L3_CHAR]

```



```

, ← [L3_MODE]
Srch/CloCall Opt, ← [L4_CHAR]
, ← [L4_MODE]
1,0,0,0,,,0,GREEN,, [\r]

```

Returns current scanner status.

Ex.2)

```

┌───────────────────┐
│ HOLD L/O           │
├───────────────────┤
│ System 1           │ Squelch Status      : CLOSE
│ 851.0125MHz       │ Mute Status        : ON
│ P NFM ATT         │ Battery Low Status : No Alert
│ S1: 5             │ Weather Alert Status : Alert
├───────────────────┤
│ GRP 2             │ WX                 │
└───────────────────┘

```

```

→ STS[\r]
← 011000,
   HOLD L/O           , ← [L1_CHAR]
   ,                  ← [L1_MODE]
   SYSTEM 1           , ← [L2_CHAR]
   ,                  ← [L2_MODE]
   851.0125MHz       , ← [L3_CHAR]
   ,                  ← [L3_MODE]
   P NFM ATT         , ← [L4_CHAR]
   ,                  ← [L4_MODE]
   S1: 5             , ← [L5_CHAR]
   ,                  ← [L5_MODE]
   GRP 2             │ WX, ← [L6_CHAR]
   ,                  ← [L6_MODE]
   0,1,0,0,,,1,GREEN,, [\r]

```

Returns current scanner status.

<COMMAND GLG>

Get Reception Status

Controller → Radio

GLG[\r]

Radio → Controller

GLG, [FRQ/TGID], [MOD], [ATT], [CTCSS/DCS], [NAME1], [NAME2], [NAME3], [SQL], [MUT],
 [SYS_TAG], [CHAN_TAG], [P25NAC] [\r]

GLG,,,,,,,,, [\r]

```

[FRQ/TGID]      : Frequency or TGID
[MOD]           : Modulation          (AM/FM/NFM/WFM/FMB)
[ATT]           : Attenuation          (0:OFF / 1:ON)
[CTCSS/DCS]    : CTCSS/DCS Status (0-231)
                *See CTCSS/DCS CODE LIST about the details of this code.
[NAME1]        : System, Site or Search Name
[NAME2]        : Group Name
[NAME3]        : Channel Name
[SQL]          : Squelch Status      (0:CLOSE / 1:OPEN)
[MUT]          : Mute Status          (0:OFF / 1:ON)

```

```

[SYS_TAG]           : Current system number tag      (0-999/NONE)
[CHAN_TAG]          : Current channel number tag     (0-999/NONE)
[P25NAC]            : P25 NAC Status   ( 0-FFF: 0-FFF / NONE: Nac None)

```

Get reception status.

The Scanner returns GLG,,,,,,,,,,,,[\r] until it detects a frequency or a TGID.

<COMMAND JPM>

Jump Mode

Controller → Radio

JPM, [JUMP_MODE], [INDEX] [\r]

Radio → Controller

JPM,OK[\r]

```

[JUMP_MODE] :   SCN_MODE      Scan mode
                SVC_MODE      Service Search mode
                CTM_MODE      Custom Search mode
                CC_MODE       Close Call Only mode
                WX_MODE       WX SCAN mode
                FTO_MODE      Tone-Out mode
[INDEX]      :   SCN_MODE      Channel Index
                SVC_MODE      PublicSafety
                                News
                                HAM
                                Marine
                                Railroad
                                Air
                                CB
                                FRS/GMRS/MURS
                                Racing
                                FM
                                Special
                                Military
                CTM_MODE      RESERVE
                CC_MODE       RESERVE
                WX_MODE       NORMAL
                                A_ONLY
                                SAME_1
                                SAME_2
                                SAME_3
                                SAME_4
                                SAME_5
                                ALL_FIPS
                FTO_MODE      RESERVE

```

Note) Scanner returns NG in the state that the mode switch cannot be done.

<COMMAND MNU>

Menu Mode
Controller → Radio
MNU, [MENU_INDEX] [\r]
Radio → Controller
MNU, OK [\r]

[MENU_INDEX]	:	SVC_MENU	:	Service Search Select Menu
WX_MENU	:		:	WX Select Menu
CCBAND_MENU	:		:	Close Call Band Filter Menu
SCR_OPT_MENU	:		:	Broadcast Screen Band Menu
GL_LIST_MENU	:		:	Search Global Lockout List Review Menu
SETTING_MENU	:		:	Setting Menu

Note) Scanner returns NG in the state that the mode switch cannot be done.

<COMMAND JNT>

Jump to Number Tag
Controller → Radio
JNT, [SYS_TAG], [CHAN_TAG] [\r]
Radio → Controller
JNT, OK [\r]

[SYS_TAG]	:	System Number Tag	(0-999/NONE)
[CHAN_TAG]	:	Channel Number Tag	(0-999/NONE)

When both [SYS_TAG] and [CHAN_TAG] are set as blank, scanner returns error.
When [SYS_TAG] is set as blank, [CHAN_TAG] is set with a number tag, scanner jump to the channel number tag in current system.
When [SYS_TAG] is set with a number tag, [CHAN_TAG] is set as blank, scanner jump to the first channel of the system number tag.

<COMMAND MDL>

Get Model Info
Controller → Radio
MDL [\r]
Radio → Controller
MDL, BCD396XT [\r]

Returns Model Information.

<COMMAND VER>

Get Firmware Version
Controller → Radio
VER [\r]
Radio → Controller
VER, Version 1.00.00 [\r]

Returns Firmware Version.

```
<COMMAND PRG>
  Enter Program Mode
  Controller → Radio
PRG[\r]
  Radio → Controller
PRG,OK[\r]
PRG,NG[\r]
```

This command is invalid when the scanner is in Menu Mode, during Direct Entry operation, during Quick Save operation.

The scanner goes to Program Mode.
The scanner displays "Remote Mode" on first line and "Keypad Lock" on second line in Program Mode.

```
<COMMAND EPG>
  Exit Program Mode
  Controller → Radio
EPG[\r]
  Radio → Controller
EPG,OK[\r]
```

The scanner exits from Program Mode.
Then the scanner goes to Scan Hold Mode.

```
<COMMAND BLT>
  Get/Set Backlight
  Controller → Radio
BLT[\r]
BLT, [EVNT], [COLOR], [DIMMER] [\r]
  Radio → Controller
BLT, [EVNT], [COLOR], [DIMMER] [\r]
BLT,OK[\r]
```

```
      [EVENT]
          IF : INFINITE
          10 : 10sec
          30 : 30sec
          KY : KEYPRESS
          SQ : SQUELCH
```

```
[COLOR]      : (BLUE,RED,MAGENTA,GREEN,CYAN,YELLOW,WHITE)
[DIMMER]     : Backlight Dimmer (1:Low / 2:Middle / 3:High)
```

Get/Set Backlight Setting.
This command is only acceptable in Programming Mode.

<COMMAND BSV >

Get/Set Battery Info

Controller → Radio

BSV [\r]

BSV, [BAT_SAVE], [CHARGE_TIME] [\r]

Radio → Controller

BSV, [BAT_SAVE], [CHARGE_TIME] [\r]

BSV,OK[\r]

[BAT_SAVE] Battery Save (0:OFF / 1:ON)

[CHARGE_TIME] Battery Charge Time (1-16)

< COMMAND COM >

Get/Set COM port setting

Controller → Radio

COM, [/r]

COM, [BAUDRATE], [RSV] [/r]

Radio → Controller

COM, [BAUDRATE], [RSV] [/r]

COM,OK[/r]

[BAUDRATE] :

OFF	:OFF
4800	:4800bps
9600	:9600bps
19200	:19200bps
38400	:38400bps
57600	:57600bps
115200	:115200b

Note:

When receive "COM,OK", next command should not be send in 2 second.
Only PC Control (Baud Rate) does not become an initial-setting value.

<COMMAND CLR>

Clear All Memory

Controller → Radio

CLR[\r]

Radio → Controller

CLR,OK[\r]

All the memories are set for initial setting.
This command is only acceptable in Programming Mode.

Note :

It takes dozens of seconds.
Only PC Control (Baud Rate) does not become an initial-setting value.

<COMMAND KBP>

Get/Set Key Beep and setting

Controller → Radio

KBP[\r]

KBP, [LEVEL], [LOCK], [SAFE] [\r]

Radio → Controller

KBP, [LEVEL], [LOCK], [SAFE] [\r]

KBP,OK[\r]

[LEVEL] : Beep Level (0:Auto / 1-15 / 99:OFF)
[LOCK] : Key Lock status (0:OFF / 1:ON)
[SAFE] : Key Safe status (0:OFF / 1:ON)

Get/Set Key Beep Setting.

This command is only acceptable in Programming Mode.

<COMMAND OMS>

Get/Set Opening Message

Controller → Radio

OMS[\r]

OMS, [L1_CHAR], [L2_CHAR], [L3_CHAR], [L4_CHAR] [\r]

Radio → Controller

OMS, [L1_CHAR], [L2_CHAR], [L3_CHAR], [L4_CHAR] [\r]

OMS,OK[\r]

[L1_CHAR] : Line1 Characters (max.16char)
[L2_CHAR] : Line2 Characters (max.16char)
[L3_CHAR] : Line3 Characters (max.16char)
[L4_CHAR] : Line4 Characters (max.16char)

If only space code is set in character area, the message returns default message.

This command is only acceptable in Programming Mode.

<COMMAND PRI>

Get/Set Priority Mode

Controller → Radio

PRI[\r] : Get Priority Mode Setting

PRI, [PRI_MODE], [MAX_CHAN], [INTERVAL] [\r]

Radio → Controller

PRI, [PRI_MODE], [MAX_CHAN], [INTERVAL] [\r]

PRI,OK[\r]

[PRI_MODE] : Priority Setting (0:OFF / 1:ON / 2:PLUS ON)
[MAX_CHAN] : Priority Scan max channels at once (1-100)
[INTERVAL] : Priority Scan Interval time (1-10)

Get/Set Priority Mode.

This command is only acceptable in Programming Mode.

<COMMAND AGV>

Get/Set Auto Gain Control

Controller → Radio

AGV[\r]

AGV, [RSV], [RSV], [A_RES], [A_REF], [A_GAIN], [D_RES], [A_GAIN] [\r]

Radio → Controller

AGV, [RSV], [RSV], [A_RES], [A_REF], [A_GAIN], [D_RES], [A_GAIN] [\r]

AGV,OK[\r]

[A_RES]	:	Analog Response Time	(-4 - +6)
[A_REF]	:	Analog Reference Gain	(-5 - +5)
[A_GAIN]	:	Analog Gain Range	(0 - 15)
[D_RES]	:	Digital Response Time	(-8 - +8)
[D_GAIN]	:	Digital Reference Gain	(-5 - +5)
[RSV]	:	Reserve Parameter	* This is always only “,”.

Get/Set AGC Setting.

This command is only acceptable in Programming Mode.

<COMMAND SCT>

Get System Count

Controller → Radio

SCT[\r]

Radio → Controller

SCT,###[\r] : ### (0 - 500)

Returns the number of stored System.

This command is only acceptable in Programming Mode.

<COMMAND SIH>

Get System Index Head

Controller → Radio

SIH[\r]

Radio → Controller

SIH, [SYS_INDEX] [\r]

Returns the first index of stored system list.

This command is only acceptable in Programming Mode.

<COMMAND SIT>

Get System Index Tail

Controller → Radio

SIT[\r]

Radio → Controller

SIT, [SYS_INDEX] [\r]

Returns the last index of stored system list.

This command is only acceptable in Programming Mode.

```

<COMMAND QSL>
Get/Set System/Site Quick Lockout
Controller → Radio
QSL[\r]
QSL, [PAGE0], [PAGE1], [PAGE2], [PAGE3], [PAGE4], [PAGE5], [PAGE6], [PAGE7], [PAGE8],
[PAGE9] [\r]
Radio → Controller
QSL, [PAGE0], [PAGE1], [PAGE2], [PAGE3], [PAGE4], [PAGE5], [PAGE6], [PAGE7], [PAGE8],
[PAGE9] [\r]
QSL,OK[\r]

```

```

[PAGE0] - [PAGE9] : ##### (each # is 0 - 2)
                   0 : Not assigned (Displayed as "-" on the scanner.)
                   1 : On           (Displayed as each number on the scanner.)
                   2 : Off          (Displayed as "*" on the scanner.)
                   The Order of Quick Key is as same as LCD Icon.
[PAGE0]           : Quick Key 1 - 9, 0
[PAGE1]           : Quick Key11 - 19,10
[PAGE2]           : Quick Key21 - 29,20
[PAGE3]           : Quick Key31 - 39,30
[PAGE4]           : Quick Key41 - 49,40
[PAGE5]           : Quick Key51 - 59,50
[PAGE6]           : Quick Key61 - 69,60
[PAGE7]           : Quick Key71 - 79,70
[PAGE8]           : Quick Key81 - 89,80
[PAGE9]           : Quick Key91 - 99,90

```

This command is only acceptable in Programming Mode.
It cannot turn on/off the Quick Key that has no System / Site.

```

<COMMAND QGL>
Get/Set Group Quick Lockout
Controller → Radio
QGL, [SYS_INDEX] [\r]
QGL, [SYS_INDEX], ##### [\r]
Radio → Controller
QGL, ##### [\r]
QGL,OK[\r]

```

```

##### (each # is 0 - 2) : Group Quick Key status of [SYS_INDEX].
                   0 : Not assigned (Displayed as "-" on the scanner.)
                   1 : On           (Displayed as each number on the scanner.)
                   2 : Off          (Displayed as "*" on the scanner.)

```

The Order of Quick Key is as same as LCD Icon (1 - 9, 0).
This command is only acceptable in Programming Mode.
It cannot turn on/off the Quick Key that has no Group.

```
<COMMAND CSY>
Create System
Controller → Radio
CSY, [SYS_TYPE], [PROTECT] [\r]
Radio → Controller
CSY, [SYS_INDEX] [\r]
```

```
[SYS_TYPE] : System Type
    CNV      : CONVENTIONAL
    MOT      : MOTOROLA TYPE
    EDC      : EDACS Narrow / Wide
    EDS      : EDACS SCAT
    LTR      : LTR
    P25S     : P25 STANDARD
    P25F     : P25 One Frequency TRUNK

[SYS_INDEX] : The Index of Created System
[PROTECT]   : Protect bit Status      (0:OFF / 1:ON)
```

Creates a system and return created system index.
The index is a handle to get/set system information.
Returns -1 if the scanner failed to create because of no resource.
This command is only acceptable in Programming Mode.

```
<COMMAND DSY>
Delete System
Controller → Radio
DSY, [SYS_INDEX] [\r]
Radio → Controller
DSY, OK [\r]
```

```
[SYS_INDEX] : System Index
```

This command deletes a System.
This command is only acceptable in Programming Mode.

```

<COMMAND SIN>
Get/Set System Info
Controller → Radio
SIN, [INDEX] [\r]
SIN, [INDEX], [NAME], [QUICK_KEY], [HLD], [LOUT], [DLY], [RSV], [RSV], [RSV], [RSV],
[RSV], [START_KEY], [RSV], [RSV], [RSV], [RSV], [RSV], [RSV], [NUMBER_TAG],
[AGC_ANALOG], [AGC_DIGITAL], [P25WAITING] [\r]
Radio → Controller
SIN, [SYS_TYPE], [NAME], [QUICK_KEY], [HLD], [LOUT], [DLY], [RSV], [RSV], [RSV], [RSV],
[RSV], [REV_INDEX], [FWD_INDEX], [CHN_GRP_HEAD], [CHN_GRP_TAIL], [SEQ_NO],
[START_KEY], [RSV], [RSV], [RSV], [RSV], [RSV], [NUMBER_TAG], [AGC_ANALOG],
[AGC_DIGITAL], [P25WAITING], [PROTECT], [RSV] [\r]
SIN,OK[\r]

```

```

[INDEX]           : System Index
[SYS_TYPE]        : System Type
    CNV           : CONVENTIONAL
    MOT           : MOTOROLA TYPE
    EDC           : EDACS Narrow / Wide
    EDS           : EDACS SCAT
    LTR           : LTR
    P25S          : P25 STANDARD
    P25F          : P25 One Frequency TRUNK
[NAME]            : Name (max.16char)
[QUICK_KEY]       : Quick Key (0-99/.(dot) means none)
[HLD]             : System Hold Time (0-255)
[LOUT]           : Lockout (0:Unlocked / 1:Lockout)
[DLY]            : Delay Time (-10,-5,-2,0,1,2,5,10,30)
[REV_INDEX]       : Reverse System Index of the Scan Setting
[FWD_INDEX]       : Forward System Index of the Scan Setting
[CHN_GRP_HEAD]    : Channel Group Index Head of the conventional system
                  or Site Index Head of the Trunked System
[CHN_GRP_TAIL]    : Channel Group Index Tail of the conventional system
                  or Site Index Tail of the Trunked System
[SEQ_NO]          : System Sequence Number (1 - 500)
[START_KEY]       : Startup Configuration Key (0-9/.(dot) means none)
[NUMBER_TAG]      : Number tag (0-999 / NONE)
[AGC_ANALOG]      : AGC Setting for Analog Audio (0:OFF / 1:ON)
[AGC_DIGITAL]     : AGC Setting for Digital Audio (0:OFF / 1:ON)
[P25WAITING]      : P25 Waiting time (0,100,200, .... , 900,1000)
[PROTECT]         : Protect bit Status (0:OFF / 1:ON)
[RSV]            : Reserve Parameter * This is always only ",".

```

Get/Set System Information.

The scanner returns only "," to punctuate for parameters which are not appropriate the system type.

In set command, the scanner neglects the parameters that are not appropriate the system type.

In set command, only "," parameters are not changed.

The set command is aborted if any format error is detected.

This command is only acceptable in Programming Mode.

When the system protect bit is ON, except [SYS_TYPE], [NAME], [REV_INDEX], [FWD_INDEX], [CHN_GRP_HEAD], [CHN_GRP_TAIL], other parameters will be send as a reserve parameter in the Radio -> Controller command.

```

<COMMAND TRN>
Get/Set Trunk Info
Controller → Radio
TRN, [INDEX] [\r]
TRN, [INDEX], [ID_SEARCH], [S_BIT], [END_CODE], [AFS], [RSV], [RSV], [EMG], [EMGL],
[FMAP], [CTM_FMAP], [RSV], [RSV], [RSV], [RSV], [RSV], [RSV], [RSV], [RSV], [RSV], [RSV],
,
[MOT_ID], [EMG_COLOR], [EMG_PATTERN], [P25NAC], [PRI_ID_SCAN] [\r]
Radio → Controller
TRN, [ID_SEARCH], [S_BIT], [END_CODE], [AFS], [RSV], [RSV], [EMG], [EMGL], [FMAP],
[CTM_FMAP], [RSV], [RSV], [RSV], [RSV], [RSV], [RSV], [RSV], [RSV], [RSV], [RSV],
[TGID_GRP_HEAD], [TGID_GRP_TAIL], [ID_LOUT_GRP_HEAD], [ID_LOUT_GRP_TAIL],
[MOT_ID], [EMG_COLOR], [EMG_PATTERN], [P25NAC], [PRI_ID_SCAN] [\r]
TRN, OK [\r]

```

```

[INDEX]      : System Index
[ID_SEARCH]  : ID Search/Scan (0:ID Scan mode / 1: Search Mode)
[S_BIT]     : Motorola Status Bit (0:Ignore, 1:Yes)
[END_CODE]  : Motorola End Code(0:Ignore,1:Analog,2:Analog and Digital)
[AFS]       : EDACS ID Format (0:Decimal / 1:AFS)
[EMG]       : Emergency Alert (0:Ignore / 1-9:Alert)
[EMGL]      : Emergency Alert Level (0:OFF / 1 - 15)
[FMAP]      : Fleet Map (0-16, 0-15:Preset, 16:Custom)
[CTM_FMAP]  : Custom Fleet Map Setting (##### : # is 0-E)
              # means Size Code of each BLOCK (from 0 to 7)
              0 : Size Code 0   5 : Size Code 5   A : Size Code 10
              1 : Size Code 1   6 : Size Code 6   B : Size Code 11
              2 : Size Code 2   7 : Size Code 7   C : Size Code 12
              3 : Size Code 3   8 : Size Code 8   D : Size Code 13
              4 : Size Code 4   9 : Size Code 9   E : Size Code 14
[TGID_GRP_HEAD] : TGID Index Head of the System
[TGID_GRP_TAIL] : TGID Index Tail of the System
[ID_LOUT_GRP_HEAD]: L/O TGID Group Index Head of the System
[ID_LOUT_GRP_TAIL]: L/O TGID Group Index Tail of the System
[MOT_ID]       : Motorola/P25 ID Format (0:Decimal / 1:HEX )
[EMG_COLOR]    : Emergency Alert Light color
                (OFF,BLUE,RED,MAGENTA,GREEN,CYAN,YELLOW,WHITE)
[EMG_PATTERN]  : Emergency Alert Light Pattern(0:ON/1:Slow /2:Fast)
[P25NAC]       : P25 NAC Status (0-FFF:0-FFF/SRCH:Nac Search)
[PRI_ID_SCAN]  : Priority ID Scan ( 0:OFF / 1: ON)
[RSV]         : Reserve Parameter * This is always only ",".

```

Get/Sets Trunked System Information.

The scanner returns only "," to punctuate for parameters which are not appropriate the system type.

In set command, the scanner neglects the parameters that are not appropriate the system.

In set command, only "," parameters are not changed.

The set command is aborted if any format error is detected.

When the system protect bit is ON, except [TGID_GRP_HEAD], [TGID_GRP_TAIL], [ID_LOUT_GRP_HEAD], [ID_LOUT_GRP_TAIL], other parameters will be send as a reserve parameter in the Radio -> Controller command.

This command is only acceptable in Programming Mode.

```

<COMMAND AST>
Append Site
Controller → Radio
AST, [SYS_INDEX], [RSV] [\r]
Radio → Controller
AST, [SITE_INDEX] [\r]

```

```

[SYS_INDEX]           : System Index
[SITE_INDEX]          : Appended Site Index

```

Append Site to the system.
Returns "-1" if the scanner failed to create because of no resource.
This command is only acceptable in Programming Mode.

```

<COMMAND SIF>
Get/Set Site Info
Controller → Radio
SIF, [INDEX] [\r]
SIF, [INDEX], [NAME], [QUICK_KEY], [HLD], [LOUT], [MOD], [ATT], [C-CH], [RSV], [RSV],
[START_KEY], [LATITUDE], [LONGITUDE], [RANGE], [GPS_ENABLE], [RSV], [MOT_TYPE],
[EDACS_TYPE], [P25WAITING], [RSV] [\r]
Radio → Controller
SIF, [RSV], [NAME], [QUICK_KEY], [HLD], [LOUT], [MOD], [ATT], [C-CH], [RSV], [RSV],
[REV_INDEX], [FWD_INDEX], [SYS_INDEX], [CHN_HEAD], [CHN_TAIL], [SEQ_NO],
[START_KEY], [LATITUDE], [LONGITUDE], [RANGE], [GPS_ENABLE], [RSV], [MOT_TYPE],
[EDACS_TYPE], [P25WAITING], [RSV] [\r]
SIF,OK[\r]

```

```

[INDEX]           : Site Index
[NAME]            : Name (max.16char)
[QUICK_KEY]       : Quick Key (0-99/(dot) means none)
[HLD]             : Site Hold Time (0-255)
[LOUT]           : Lockout (0:Unlocked / 1:Lockout)
[MOD]            : Modulation (AUTO/FM/NFM)
[ATT]            : Attenuation (0:OFF/1:ON)
[C-CH]           : Control Channel Only (0:OFF / 1:ON)
[REV_INDEX]      : Reverse Site Index of the Scan Setting
[FWD_INDEX]      : Forward Site Index of the Scan Setting
[SYS_INDEX]      : System Index
[CHN_HEAD]       : Channel Index Head of the Group List
[CHN_TAIL]       : Channel Index Tail of the Group List
[SEQ_NO]         : Site Sequence Number (1-256)
[START_KEY]      : Startup Configuration (0-9/(dot) means none)
[LATITUDE]       : North or South Latitude
[LONGITUDE]      : West or East Longitude
[RANGE]          : Range (1-250 : 1= 0.5 mile or km)
[GPS_ENABLE]     : GPS Location detection (0:OFF/1:ON)
[MOT_TYPE]       : Band type for MOT/EDACS (STD/ SPL/CUSTOM)
[EDACS_TYPE]     : EDACS (WIDE/NARROW)
[P25WAITING]     : P25 Waiting time (0,100,200,300, .... , 900,1000)
[RSV]            : Reserve Parameter * This is always only ",".

```

Get/Set Site Information.

The scanner returns only "," to punctuate for parameters which are not appropriate the site type.

In set command, the scanner neglects the parameters that are not appropriate the system type.

In set command, only "," parameters are not changed.

The set command is aborted if any format error is detected.

When the system protect bit is ON, except [REV_INDEX], [FWD_INDEX], [SYS_INDEX], [CHN_HEAD], [CHN_TAIL], other parameters will be send as a reserve parameter in the Radio -> Controller command.

This command is only acceptable in Programming Mode.

```
<COMMAND MCP>
Get/Set Motorola Custom Band Plan
Controller → Radio
MCP, [INDEX] [\r]
MCP, [INDEX], [LOWER1], [UPPER1], [STEP1], [OFFSET1], [LOWER2], [UPPER2], [STEP2],
[OFFSET2], [LOWER3], [UPPER3], [STEP3], [OFFSET3], [LOWER4], [UPPER4], [STEP4],
[OFFSET4], [LOWER5], [UPPER5], [STEP5], [OFFSET5], [LOWER6], [UPPER6], [STEP6],
[OFFSET6] [\r],
Radio → Controller
MCP, [LOWER1], [UPPER1], [STEP1], [OFFSET1], [LOWER2], [UPPER2], [STEP2],
[OFFSET2], [LOWER3], [UPPER3], [STEP3], [OFFSET3], [LOWER4], [UPPER4], [STEP4],
[OFFSET4], [LOWER5], [UPPER5], [STEP5], [OFFSET5], [LOWER6], [UPPER6], [STEP6],
[OFFSET6] [\r],
MCP, OK [\r]
```

```
[INDEX]      : Site Index
[LOWER n]    : Lower Frequency n
[UPPER n]    : Upper Frequency n
[STEP n]     : Step n
               "500": 5.0k           "625": 6.25k           "1000": 10.0k
               "1250": 12.5k         "1500": 15.0k         "1875": 18.75k
               "2000": 20.0k         "2500": 25.0k         "3000": 30.0k
               "3125": 31.25k        "3500": 35.0k         "3750": 37.5k
               "4000": 40.0k         "4375": 43.75k        "4500": 45.0k
               "5000": 50.0k         "5500": 55.0k         "5625": 56.25k
               "6000": 60.0k         "6250": 62.5k         "6500": 65.0k
               "6875": 68.75k        "7000": 70.0k         "7500": 75.0k
               "8000": 80.0k         "8125": 81.25k        "8500": 85.0k
               "8750": 87.5k         "9000": 90.0k         "9375": 93.75k
               "9500": 95.0k         "10000": 100.0k
[OFFSETn]    : Offset n (-1023 to 1023)
```

Get/Sets Band Plan Setting for MOT 800 custom/VHF/UHF site.

In set command, if only "," parameters are send the Band Plan setting of the site will not changed.

The set command is aborted if any format error is detected.

When the system protect bit is ON, all the parameters will be send as a reserve parameter in the Radio -> Controller command.

Before using this command, user should set Band Plan type as "Custom" first by using SIF command.

This command is only acceptable in Programming Mode.

```

<COMMAND ABP>
  Get/Set APCO-P25 Band Plan
  Controller → Radio
    ① ABP,[INDEX][\r]
    ②
ABP,[INDEX],[BASE_FREQ_0],[SPACING_FREQ_0],[BASE_FREQ_1],[SPACING_FREQ_1],.
.
[BASE_FREQ_E],[SPACING_FREQ_E],[BASE_FREQ_F],[SPACING_FREQ_F][\r]
  Radio → Controller
    ① ABP,[BASE_FREQ_0],[SPACING_FREQ_0],[BASE_FREQ_1],[SPACING_FREQ_1],.
.
[BASE_FREQ_E],[SPACING_FREQ_E],[BASE_FREQ_F],[SPACING_FREQ_F][\r]
    ② ABP,OK[\r]

```

```

[INDEX]           : Site Index
[BASE_FREQ_n]     : Base frequency (MHz) (25.0000MHz to 1300.0000MHz,
                   5.0Hz step)
                   Base_FREQ_n = (base frequency * 10^6) / 5
                   (Hexadecimal number)
[SPACING_FREQ_n]  : Spacing frequency(kHz) (0.125kHz to 128.0kHz,
                   0.125kHz step)
                   SPACING_FREQ_n = (spacing frequency *10^3)/125
                   (Hexadecimal number)
                   *n : Base Plan number

```

```

EX.) Base frequency = 851.00625MHz, Spacing frequency = 6.25kHz
     [BASE_FREQ_n] = (851.00625*10^6)/5 = A2510A2(H)
     [SPACING_FREQ_n] = (6.25*10^3)/125= 32      (H)

```

Band Plan that has no data returns "0".
 When the system protect bit is ON, all the parameters will be send as a reserve parameter in the Radio -> Controller command.
 This command is only acceptable in Programming Mode.

<COMMAND TFQ>

Get/Set Trunk Frequency Info

Controller → Radio

TFQ, [CHN_INDEX] [\r]

TFQ, [CHN_INDEX], [FRQ], [LCN], [LOUT], [RSV], [NUMBER_TAG], [VOL_OFFSET], [RSV] [\r]

Radio → Controller

TFQ, [FRQ], [LCN], [LOUT], [REV_INDEX], [FWD_INDEX], [SYS_INDEX], [GRP_INDEX], [RSV], [NUMBER_TAG], [VOL_OFFSET], [RSV] [\r]

TFQ,OK[\r]

[CHN_INDEX]	:	Trunk Frequency Index
[FRQ]	:	Trunk Frequency
[LCN]	:	LCN (EDACS WIDE/NARROW system: 0 to 20 LTR system: 0 to 30)
[LOUT]	:	Lockout (0:Unlocked / 1:Lockout)
[REV_INDEX]	:	Reverse Frequency Index of the Site
[FWD_INDEX]	:	Forward Frequency Index of the Site
[SYS_INDEX]	:	System Index of the Frequency
[GRP_INDEX]	:	Index of the Site
[NUMBER_TAG]	:	Number tag (0-999 / NONE)
[VOL_OFFSET]	:	Volume Offset (-3 - +3)

In set command, only "," parameters are not changed.

The set command is aborted if any format error is detected.

This command is only acceptable in Programming Mode.

For Motorola or EDACS SCAT System, [LCN] is ignored.

When the system protect bit is ON, except [REV_INDEX], [FWD_INDEX], [SYS_INDEX], [GRP_INDEX], other parameters will be send as a reserve parameter in the Radio -> Controller command.

[NUMBER_TAG] and [VOL_OFFSET] are just used for SCAT system.

<COMMAND AGC>

Append Channel Group

Controller → Radio

AGC, [SYS_INDEX] [\r]

Radio → Controller

AGC, [GRP_INDEX] [\r]

[SYS_INDEX]	:	System Index
[GRP_INDEX]	:	appended Channel Group Index

Append Channel Group to the system.

Returns "-1" if the scanner failed to create because of no resource.

This command is only acceptable in Programming Mode.

```

<COMMAND AGT>
Append TGID Group
Controller → Radio
AGT, [SYS_INDEX] [\r]
Radio → Controller
AGT, [GRP_INDEX] [\r]

```

```

[SYS_INDEX]          : System Index
[GRP_INDEX]         : appended TGID Group Index

```

Append TGID Group to the system.
Returns "-1" if the scanner failed to create because of no resource.
This command is only acceptable in Programming Mode.

```

<COMMAND DGR>
Delete Group / Site
Controller → Radio
DGR, [INDEX] [\r]
Radio → Controller
DGR,OK[\r]

```

```

[INDEX]           : Group / Site Index

```

This command deletes a Channel Group, TGID Group or Site.
This command is only acceptable in Programming Mode.

```

<COMMAND GIN>
Get/Set Group Info
Controller → Radio
GIN, [GRP_INDEX] [\r]
GIN, [GRP_INDEX], [NAME], [QUICK_KEY], [LOUT], [LATITUDE], [LONGITUDE], [RANGE],
[GPS_ENABLE] [\r]
Radio → Controller
GIN, [GRP_TYPE], [NAME], [QUICK_KEY], [LOUT], [REV_INDEX], [FWD_INDEX], [SYS_INDEX],
[CHN_HEAD], [CHN_TAIL], [SEQ_NO] , [LATITUDE], [LONGITUDE], [RANGE], [GPS_ENABLE]
[\r]
GIN,OK[\r]

```

For Group Information

```

[GRP_INDEX]          : Group Index
[GRP_TYPE]           : Group Type          (C: Channel Group / T: TGID Group)
[NAME]               : Name                (max.16char)
[QUICK_KEY]          : Quick Key (1-9,0: means 10, .(dot): means none)
[LOUT]               : Lockout              (0:Unlocked / 1:Lockout)
[REV_INDEX]          : Reverse Group Index of the System
[FWD_INDEX]          : Forward Group Index of the System
[SYS_INDEX]          : System Index
[CHN_HEAD]           : Channel Index Head of the Group List
[CHN_TAIL]           : Channel Index Tail of the Group List
[SEQ_NO]             : Group Sequence Number of the System
[LATITUDE]           : North or South Latitude
[LONGITUDE]          : West or East Longitude
[RANGE]              : Range                (1-250 : 1= 0.5 mile or km)
[GPS_ENABLE]         : GPS Location detection   (0:OFF/1:ON)

```

Get/Set Group Information.

In set command, only "," parameters are not changed.

The set command is aborted if any format error is detected.

When the system protect bit is ON, except [NAME], [REV_INDEX], [FWD_INDEX], [SYS_INDEX], [CHN_HEAD], [CHN_TAIL], other parameters will be send as a reserve parameter in the Radio -> Controller command.

This command is only acceptable in Programming Mode.

<COMMAND ACC>

Append Channel / Trunk Frequency

Controller → Radio

ACC, [GRP_INDEX] [\r]

Radio → Controller

ACC, [CHN_INDEX] [\r]

[GRP_INDEX] : Channel Group Index

[CHN_INDEX] : Appended Channel Index

- or -

[GRP_INDEX] : Site Index

[CHN_INDEX] : Appended Trunk Frequency Index

Append Channel to the group. Or, append Trunk Frequency to the Site.

Returns "-1" if the scanner failed to create because of no resource.

This command is only acceptable in Programming Mode.

<COMMAND ACT>

Append TGID

Controller → Radio

ACT, [GRP_INDEX] [\r]

Radio → Controller

ACT, [INDEX] [\r]

[GRP_INDEX] : TGID Group Index

[TGID_INDEX] : appended TGID Index

Append TGID to the group.

Returns "-1" if the scanner failed to create because of no resource.

This command is only acceptable in Programming Mode.

<COMMAND DCH>

Delete Channel

Controller → Radio

DCH, [INDEX] [\r]

Radio → Controller

DCH, OK [\r]

[INDEX] : Channel Index, TGID Index or Trunked Frequency Index

This command deletes a Channel and TGID.

This command is also valid for deleting a Trunk Frequency.

This command is only acceptable in Programming Mode.

```

<COMMAND CIN>
Get/Set Channel Info
Controller → Radio
CIN, [INDEX] [\r]
CIN, [INDEX], [NAME], [FRQ], [MOD], [CTCSS/DCS], [TLOCK], [LOUT], [PRI], [ATT], [ALT],
[ALTL], [RSV], [AUDIO_TYPE], [P25NAC], [NUMBER_TAG], [ALT_COLOR], [ALT_PATTERN],
[VOL_OFFSET] [\r]
Radio → Controller
CIN, [NAME], [FRQ], [MOD], [CTCSS/DCS], [TLOCK], [LOUT], [PRI], [ATT], [ALT], [ALTL],
[REV_INDEX], [FWD_INDEX], [SYS_INDEX], [GRP_INDEX], [RSV], [AUDIO_TYPE], [P25NAC],
[NUMBER_TAG], [ALT_COLOR], [ALT_PATTERN], [VOL_OFFSET] [\r]
CIN,OK[\r]

```

```

[INDEX]           : Channel Index
[NAME]            : Name (max.16char)
[FRQ]             : Channel Frequency
[MOD]             : Modulation      (AUTO/AM/FM/NFM/WFM/FMB)
[ATT]             : Attenuation      (0:OFF / 1:ON)
[CTCSS/DCS]      : CTCSS/DCS Status  (0-231 )
                  *See CTCSS/DCS CODE LIST about the details of this code.
[TLOCK]          : CTCSS/DCS Tone Lockout(0:OFF / 1:ON)
[LOUT]           : Lockout           (0:Unlocked / 1:Lockout)
[PRI]            : Priority           (0:OFF / 1:ON)
[ALT]            : Alert Tone        (0:OFF / 1-9:Tone No)
[ALTL]           : Alert Tone Level  (0:AUTO/ 1-15)
[REV_INDEX]      : Reverse Channel Index of the Chan0nel Group
[FWD_INDEX]      : Forward Channel Index of the Channel Group
[SYS_INDEX]      : System Index of the Channel
[GRP_INDEX]      : Group Index of the Channel
[AUDIO_TYPE]     : Audio Type      (0:All/1:Analog Only/2:Digital Only)
[P25NAC]         : P25 NAC Status  ( 0-FFF: 0-FFF / SRCH: Nac Search)
[NUMBER_TAG]     : Number tag      (0-999 / NONE)
[ALT_COLOR]      : Alert Light color
                  (OFF,BLUE,RED,MAGENTA,GREEN,CYAN,YELLOW,WHITE)
[ALT_PATTERN]    : Alert Light Pattern(0:ON / 1:SLow / 2:Fast)
[VOL_OFFSET]     : Volume Offset    (-3 - +3)

```

Get/Set Channel Information.

In set command, only ", " parameters are not changed.

The set command is aborted if any format error is detected.

This command is only acceptable in Programming Mode.

When the system protect bit is ON, except [REV_INDEX], [FWD_INDEX], [SYS_INDEX], [GRP_INDEX], other parameters will be send as a reserve parameter in the Radio -> Controller command.

```

<COMMAND TIN>
Get/Set TGID Info
Controller → Radio
TIN, [INDEX] [\r]
TIN, [INDEX], [NAME], [TGID], [LOUT], [PRI], [ALT], [ALTL], [RSV], [AUDIO_TYPE],
[NUMBER_TAG], [ALT_COLOR], [ALT_PATTERN], [VOL_OFFSET] [\r]
Radio → Controller
TIN, [NAME], [TGID], [LOUT], [PRI], [ALT], [ALTL], [REV_INDEX], [FWD_INDEX],
[SYS_INDEX], [GRP_INDEX], [RSV], [AUDIO_TYPE], [NUMBER_TAG], [ALT_COLOR],
[ALT_PATTERN], [VOL_OFFSET] [\r]
TIN, OK [\r]

```

```

[INDEX]           : TGID Index
[NAME]            : Name (max.16char)
[TGID]            : TGID
[LOUT]            : Lockout                (0:Unlocked / 1:Lockout)
[PRI]             : Priority                (0:OFF / 1:ON)
[ALT]             : Alert Tone              (0:OFF / 1-9:Tone No)
[ALTL]            : Alert Tone Level        (0:AUTO/ 1-15)
[REV_INDEX]       : Reverse TGID Index of the Group
[FWD_INDEX]       : Forward TGID Index of the Group
[SYS_INDEX]       : System Index of the TGID
[GRP_INDEX]       : Group Index of the TGID
[AUDIO_TYPE]      : Audio Type (0:All/1:Analog Only/2: Digital Only)
[NUMBER_TAG]      : Number tag              (0-999 / NONE)
[ALT_COLOR]       : Alert Light color
                  (OFF,BLUE,RED,MAGENTA,GREEN,CYAN,YELLOW,WHITE)
[ALT_PATTERN]     : Alert Light Pattern(0:ON / 1:Slow / 2:Fast)
[VOL_OFFSET]      : Volume Offset           (-3 - +3)

```

Get/Set TGID Information.

In set command, only ", " parameters are not changed.

The set command is aborted if any format error is detected.

This command is only acceptable in Programming Mode.

When the system protect bit is ON, except [REV_INDEX], [FWD_INDEX], [SYS_INDEX], [GRP_INDEX], other parameters will be send as a reserve parameter in the Radio -> Controller command.

```

<COMMAND GLI>
Get Lockout TGID (for Rvw L/O ID)
Controller → Radio
GLI, [SYS_INDEX] [\r]
Radio → Controller
GLI, [TGID] [\r]
GLI, -1 [\r]           : No more lockout TGID

```

This command is used to get L/O TGID list of a system.

You should call this command again and again to get all L/O TGID until the scanner returns "-1".

"-1" means that no more L/O TGID exists.

When the system protect bit is ON, only "-1" will be send in the Radio -> Controller command.

This command is only acceptable in Programming Mode.

```

<COMMAND SLI>
Get Search L/O TGID
Controller → Radio
SLI,[SYS_INDEX][\r]
Radio → Controller
SLI,[TGID][\r]
SLI,-1[\r]          : No more lockout TGID

```

This command is used to get Search L/O TGID list of the system. Search L/O TGID is the L/O TGID which doesn't belong to any group in the system as a TGID. Compared with GLI command, this command doesn't return any L/O TGID which is belong to one of group in the system. You should call this command again and again to get all L/O TGID until the scanner returns "-1". "-1" means that no more L/O TGID exists. This command is only acceptable in Programming Mode.

```

<COMMAND ULI>
Unlock TGID (for Rvw L/O ID)
Controller → Radio
ULI,[SYS_INDEX],[TGID][\r]
Radio → Controller
ULI,OK[\r]

```

This command unlocks a L/O TGID in a system. The TGID is deleted from L/O list. This command is only acceptable in Programming Mode.

```

<COMMAND LOI>
Lockout ID (TGID)
Controller → Radio
LOI,[SYS_INDEX],[TGID][\r]
Radio → Controller
LOI,OK[\r]

```

This command locks out a TGID for the system. The TGID is added to L/O list. This command is only acceptable in Programming Mode.

```

<COMMAND REV>
Get Rev Index
Controller → Radio
REV,[INDEX][\r]
Radio → Controller
REV,[INDEX][\r]

```

[INDEX] : Index of system, site, group, channel, TGID or Location Alert System.

Returns reverse(backward) index of the index in the memory chain. Returns -1 if no more index exists. This command is only acceptable in Programming Mode.

<COMMAND FWD>
Get Fwd Index
Controller → Radio
FWD, [INDEX] [\r]
Radio → Controller
FWD, [INDEX] [\r]

[INDEX] : Index of system, site, group, channel, TGID or
Location Alert System.

Returns forward index of the index in the memory chain.
Returns -1 if no more index exists.
This command is only acceptable in Programming Mode.

<COMMAND RMB>
Get Remains of Memory Block
Controller → Radio
RMB [\r]
Radio → Controller
RMB, ##### [\r]

Returns the number of idle (free) memory block.
: ##### (not zero-padding)
This command is only acceptable in Programming Mode.

<COMMAND MEM>
Get Memory Used
Controller → Radio
MEM [\r]
Radio → Controller
MEM, [MEMORY_USED], [SYS], [SITE], [CHN], [LOC] [\r]

[MEMORY_USED] : The percent of memory that is used (0 - 100)
[SYS] : The number of systems that is created (0 - 500)
[SITE] : The number of sites that is created (0 - 1000)
[CHN] : The number of channels that is created (0 - 25000)
[LOC] : The number of location system that is created (0 - 1000)

This command is only acceptable in Programming Mode.

<COMMAND LIH>
Get Location Alert System Index Head
Controller → Radio
LIH, [LAS_TYPE] [\r]
Radio → Controller
LIH, [INDEX] [\r]

[LAS_TYPE] : Location Alert Type
(POI:POI / DROAD: Dangerous Road / DXING : Dangerous Xing)

Returns the first index of stored location alert system list.
This command is only acceptable in Programming Mode.

<COMMAND LIT>
Get Location Alert System Index Tail
Controller → Radio
LIT, [LAS_TYPE] [\r]
Radio → Controller
LIT, [INDEX] [\r]

[LAS_TYPE] : Location Alert Type
(POI:POI / DROAD: Dangerous Road / DXING : Dangerous Xing)

Returns the last index of stored location alert system list.
This command is only acceptable in Programming Mode.

<COMMAND CLA>
Create Location Alert System
Controller → Radio
CLA, [LAS_TYPE] [\r]
Radio → Controller
CLA, [INDEX] [\r]

[LAS_TYPE] : Location Alert Type
(POI: POI / DROAD: Dangerous Road / DXING: Dangerous Xing)
[INDEX] : Location Alert System Index

Creates a system and return created location alert system index.
The index is a handle to get/set location alert system information.
Returns "-1" if the scanner failed to create because of no resource.
This command is only acceptable in Programming Mode.

<COMMAND DLA>
Delete Location Alert System
Controller → Radio
DLA, [INDEX] [\r]
Radio → Controller
DLA, OK [\r]

[INDEX] : Location Alert System Index

This command deletes a location alert system.
This command is only acceptable in Programming Mode.

```

<COMMAND LIN>
Get/Set Location Alert System Info
Controller → Radio
LIN, [INDEX] [\r]
LIN, [INDEX], [LAS_TYPE], [NAME], [LOUT], [ALT], [ALTL], [LATITUDE], [LONGITUDE],
[RANGE], [SPEED], [DIR], [ALT_COLOR], [ALT_PATTERN] [\r]
Radio → Controller
LIN, [LAS_TYPE], [NAME], [LOUT], [ALT], [ALTL], [REV_INDEX], [FWD_INDEX], [SEQ_NO],
[LATITUDE], [LONGITUDE], [RANGE], [SPEED], [DIR], [ALT_COLOR], [ALT_PATTERN] [\r]
LIN,OK[\r]

```

```

[INDEX]           : Location Alert System Index
[LAS_TYPE]        : Location Alert Type
                   (POI: POI / DROAD: Dangerous Road / DXING: Dangerous Xing)
[NAME]            : Name                (max.16char)
[LOUT]            : Lockout              (0:Unlocked / 1:Lockout)
[ALT]             : Alert Tone           (0:OFF/1 - 4:Tone No.)
[ALTL]            : Alert Tone Level     (0:AUTO/1-15)
[REV_INDEX]       : Reverse System Index of Location Alert System
[FWD_INDEX]       : Forward System Index of Location Alert System
[SEQ_NO]          : Location Alert System Sequence Number
[LATITUDE]        : North or South Latitude
[LONGITUDE]       : West or East Longitude
[RANGE]           : Range                (1-80: 1=0.05 mile or km)
[SPEED]           : Speed Limit          (0-200: 1 means 1 mile/hour or km/h)
[DIR]             : Heading              (0-358/360 : 2' step, 360=All range)
[ALT_COLOR]       : Alert Light color
                   (OFF,BLUE,RED,MAGENTA,GREEN,CYAN,YELLOW,WHITE)
[ALT_PATTERN]     : Alert Light Pattern(0:ON / 1:SLow / 2:Fast)

```

Get/Set Location Alert System Information.

In set command, the scanner neglects the parameters that are not appropriate the system type.

In set command, only "," parameters are not changed.

The set command is aborted if any format error is detected.

This command is only acceptable in Programming Mode.

```

<COMMAND SCO>
Get/Set Search/Close Call Settings
Controller → Radio
SCO[\r]
SCO, [RSV], [MOD], [ATT], [DLY], [RSV], [CODE_SRCH], [BSC], [REP], [RSV], [RSV],
[ MAX_STORE], [RSV], [AGC_ANALOG], [AGC_DIGITAL], [P25WAITING] [\r]
Radio → Controller
SCO, [RSV], [MOD], [ATT], [DLY], [RSV], [CODE_SRCH], [BSC], [REP], [RSV], [RSV],
[ MAX_STORE], [RSV], [AGC_ANALOG], [AGC_DIGITAL], [P25WAITING] [\r]
SCO,OK[\r]

```

```

[MOD]      : Modulation          (AUTO/AM/FM/NFM/WFM/FMB)
[ATT]      : Attenuation         (0:OFF / 1:ON)
[DLY]      : Delay Time         (-10,-5,-2,0,1,2,5,10,30)
[CODE_SRCH]: CTCSS/DCS Search
            (0:OFF / 1: CTCSS/DCS / 2: P25 NAC Search)
[BSC]      : Broadcast Screen
            (16digit: #####*##)
            (each # is 0 or 1)  |||||+---- Band10
            0 means OFF        |||||      :
            1 means ON         |||||+---- Band 2
                               |||||+---- Band 1
                               |||||+---- Reserve
                               |||+----- NOAA WX
                               ||+----- VHF TV
                               |+----- UHF TV
                               +----- FM
                               +----- Pager
[REP]      : Repeater Find      (0:OFF / 1:ON)
[ MAX_STORE]: Max Auto Store    (1-256)
[AGC_ANALOG]: AGC Setting for Analog Audio (0:OFF / 1:ON)
[AGC_DIGITAL]: AGC Setting for Digital Audio (0:OFF / 1:ON)
[P25WAITING]: P25 Waiting time (0,100,200,300, .... , 900,1000)

```

Get/Set Search/Close Call Settings.
 In set command, only "," parameters are not changed.
 The set command is aborted if any format error is detected.
 This command is only acceptable in Programming Mode.

```

<COMMAND BBS>
Get/Set Broadcast Screen Band Settings
Controller → Radio
BBS, [INDEX] [\r]
BBS, [INDEX], [LIMIT_L], [LIMIT_H] [\r]
Radio → Controller
BBS, [LIMIT_L], [LIMIT_H] [\r]
BBS,OK[\r]

```

```

[INDEX]    : Index              (1-9,0 means 10)
[LIMIT_L]  : Lower Limit Frequency (00000000 -99999999)
[LIMIT_H]  : Upper Limit Frequency (00000000 -99999999)

```

Get/Set Broadcast Screen Band Settings.
 This command is Only acceptable in Programming Mode.

```

<COMMAND SHK>
Get/Set Search Key Settings
Controller → Radio
SHK[\r]
SHK,[SRCH_KEY_1],[SRCH_KEY_2],[SRCH_KEY_3],[RSV],[RSV],[RSV][\r]
Radio → Controller
SHK,[SRCH_KEY_1],[SRCH_KEY_2],[SRCH_KEY_3],[RSV],[RSV],[RSV][\r],SHK,OK[\r]

```

```

[SRCH_KEY_1] - [SRCH_KEY_3] : Search Range
.(dot) : Not assign
PublicSafety: Public Safety range CUSTOM_1: Custom 1 range
News : News range CUSTOM_2: Custom 2 range
HAM : HAM Radio range CUSTOM_3: Custom 3 range
Marine : Marine range CUSTOM_4: Custom 4 range
Railroad : Railroad range CUSTOM_5: Custom 5 range
Air : Air range CUSTOM_6: Custom 6 range
CB : CB Radio range CUSTOM_7: Custom 7 range
FRS/GMRS/MURS: FRS/GMRS/MURS range CUSTOM_8: Custom 8 range
Racing : Racing range CUSTOM_9: Custom 9 range
FM : FM Broadcast range CUSTOM_10: Custom 10 range
Special : Special range TONE_OUT: Tone Out mode
Military : Military Air range B_SCOPE: Band Scope

```

Get/Set Search Key Settings.
This command is only acceptable in Programming Mode.

```

<COMMAND GLF>
Get Global Lockout Freq
Controller → Radio
GLF[\r]
Radio → Controller
GLF,[FRQ][\r]
GLF,-1[\r]

```

```

[FRQ] : Lockout Frequency (250000-13000000)

```

This command is used to get Global L/O frequency list.
You should call this command again and again to get all-global L/O frequency until the scanner returns "-1".
"-1" means that no more L/O frequency exists.
This command is only acceptable in Programming Mode.

```

<COMMAND ULF>
Unlock Global L/O
Controller → Radio
ULF,[FRQ][\r]
Radio → Controller
ULF,OK[\r]

```

```

[FRQ] : Lockout Frequency (250000-13000000)

```

This command unlocks a L/O frequency.
The frequency is deleted from L/O list.
This command is only acceptable in Programming Mode.

```

<COMMAND LOF >
Lock Out Frequency
Controller → Radio
LOF, [FRQ] [\r]
Radio → Controller
LOF, OK [\r]

```

```

[FRQ] : Frequency (250000-13000000)
This command locks out a frequency.
The frequency is added to L/O list.
This command is only acceptable in Programming Mode.

```

```

<COMMAND CLC>
Get/Set Close Call Settings
Controller → Radio
CLC [\r]
CLC, [CC_MODE], [CC_OVERRIDE], [RSV], [ALTB], [ALTL], [ALTP], [CC_BAND], [LOUT],
[HLD], [QUICK_KEY], [NUMBER_TAG], [ALT_COLOR], [ALT_PATTERN] [\r]
Radio → Controller
CLC, [CC_MODE], [CC_OVERRIDE], [RSV], [ALTB], [ALTL], [ALTP], [CC_BAND], [LOUT],
[HLD], [QUICK_KEY], [NUMBER_TAG], [ALT_COLOR], [ALT_PATTERN] [\r]
CLC, OK [\r]

```

```

[CC_MODE] : Mode ( 0:OFF / 1:CC PRI / 2:CC DND)
[CC_OVERRIDE] : Override (1:ON / 0:OFF)
[ALTB] : Alert Beep (0:OFF / 1-9:Tone No)
[ALTL] : Alert Tone Level (0:AUTO/ 1-15)
[ALTP] : Close Call Pause
3 : 3 sec 5 : 5 sec
10 : 10 sec 15 : 15 sec
30 : 30 sec 45 : 45 sec
60 : 60 sec INF : Infinite
[CC_BAND] : Close Call Band (7digit ##### )
(each # is 0 or 1) |||||+- 800MHz+
0 means OFF |||||+-- UHF
1 means ON ||||+---- VHF HIGH2
|||+----- VHF HIGH1
||+----- AIR BAND
|+----- VHF LOW2
+----- VHF LOW1
[LOUT] : Lockout for CC Hits with Scan(0:Unlocked/1:Lockout)
[HLD] : System Hold Time for CC Hits with Scan (0-255)
[QUICK_KEY] : Quick Key for CC Hits with Scan (0 - 99/(.dot) )
*"(dot)" means that nothing is assigned.
[NUMBER_TAG] : Number tag (0-999 / NONE)
[ALT_COLOR] : Alert Light color
(OFF, BLUE, RED, MAGENTA, GREEN, CYAN, YELLOW, WHITE)
[ALT_PATTERN] : Alert Light Pattern(0:ON / 1:Slow / 2:Fast)
[RSV] : Reserve Parameter * This is always only ", ".

```

```

Get/Set Close Call Settings.
In set command, only ", " parameters are not changed.
The set command is aborted if any format error is detected.
This command is only acceptable in Programming Mode.

```

```

<COMMAND SSP>
Get/Set Service Search Settings
Controller → Radio
SSP,[SRCH_INDEX][\r]
SSP,[SRCH_INDEX],[DLY],[ATT],[HLD],[LOUT],[QUICK_KEY],[START_KEY],[RSV],
[NUMBER_TAG],[AGC_ANALOG],[AGC_DIGITAL],[P25WAITING] [\r]
Radio → Controller
SSP,[SRCH_INDEX],[DLY],[ATT],[HLD],[LOUT],[QUICK_KEY],[START_KEY],[RSV],
[NUMBER_TAG],[AGC_ANALOG],[AGC_DIGITAL],[P25WAITING] [\r]
SSP,OK[\r]

```

```

[SRCH_INDEX]      : Service Search Range
                   1 : Public Safety 6 : Air           12 : Special
                   2 : News           7 : CB Radio     15 : Military Air
                   3 : HAM Radio      8 : FRS/GMRS/MURS
                   4 : Marine         9 : Racing
                   5 : Railroad       11 : FM Broadcast
[DLY]             : Delay Time           (-10,-5,-2,0,1,2,5,10,30)
[ATT]             : Attenuation           (0:OFF/1:ON)
[HLD]             : System Hold Time for Search with Scan(0-255)
[LOUT]           : Lockout for Search with Scan(0:Unlocked/1:Lockout)
[QUICK_KEY]      : Quick Key             ( 0 - 99 / .(dot) )
[START_KEY]      : Startup Configuration Key ( 0 - 9 / .(dot) )
[NUMBER_TAG]     : Number tag            (0-999 / NONE)
[AGC_ANALOG]     : AGC Setting for Analog Audio (0:OFF / 1:ON)
[AGC_DIGITAL]    : AGC Setting for Digital Audio (0:OFF / 1:ON)
[P25WAITING]     : P25 Waiting time (0,100,200,300, .... , 900,1000)

```

The set command is aborted if any format error is detected.
This command is only acceptable in Programming Mode.

```

<COMMAND CSG>
Get/Set Custom Search Group
Controller → Radio
CSG[\r]
CSG,#####[\r]      : Status of Each Search Range
Radio → Controller
CSG,#####[\r]
CSG,OK[\r]

```

```
##### (each # is 0 or 1) : 0 : valid / 1 : invalid
```

The Order of Range is as same as LCD Icon (1 - 10).
Get/Set current status of the custom search range.
This command is only acceptable in Programming Mode.
*It can not set all Custom Search Ranges to "0".

```

<COMMAND CBP>
Get/Set C-Ch Only Custom Search MOT Band Plan Settings
Controller → Radio
CBP, [SRCH_INDEX] [\r]
CBP, [SRCH_INDEX], [MOT_TYPE], [LOWER1], [UPPER1], [STEP1], [OFFSET1], [LOWER2],
[UPPER2], [STEP2], [OFFSET2], [LOWER3], [UPPER3], [STEP3], [OFFSET3], [LOWER4],
[UPPER4], [STEP4], [OFFSET4], [LOWER5], [UPPER5], [STEP5], [OFFSET5], [LOWER6],
[UPPER6], [STEP6], [OFFSET6] [\r],
Radio → Controller
CBP, [MOT_TYPE], [LOWER1], [UPPER1], [STEP1], [OFFSET1], [LOWER2], [UPPER2], [STEP2],
[OFFSET2], [LOWER3], [UPPER3], [STEP3], [OFFSET3], [LOWER4], [UPPER4], [STEP4],
[OFFSET4], [LOWER5], [UPPER5], [STEP5], [OFFSET5], [LOWER6], [UPPER6], [STEP6],
[OFFSET6] [\r],
CBP, OK [\r]

```

```

[SRCH_INDEX]      : Index          (1-9,0 means 10)
[MOT_TYPE]        : Band type for MOT(STD/ SPL/CUSTOM)
[LOWER n]        : Lower Frequency n
[UPPER n]         : Upper Frequency n
[STEP n]          : Step n
                   "500": 5.0k          "625": 6.25k          "1000": 10.0k
                   "1250": 12.5k        "1500": 15.0k        "1875": 18.75k
                   "2000": 20.0k        "2500": 25.0k        "3000": 30.0k
                   "3125": 31.25k       "3500": 35.0k        "3750": 37.5k
                   "4000": 40.0k        "4375": 43.75k       "4500": 45.0k
                   "5000": 50.0k        "5500": 55.0k        "5625": 56.25k
                   "6000": 60.0k        "6250": 62.5k        "6500": 65.0k
                   "6875": 68.75k       "7000": 70.0k        "7500": 75.0k
                   "8000": 80.0k        "8125": 81.25k       "8500": 85.0k
                   "8750": 87.5k        "9000": 90.0k        "9375": 93.75k
                   "9500": 95.0k        "10000": 100.0k
[OFFSETn]         : Offset n (-1023 to 1023)

```

Get/Sets Band Plan Setting for MOT 800custom/VHF/UHFsite when trunking control channel in custom search.

In set command, if only "," parameters are send the Band Plan setting will not changed. The set command is aborted if any format error is detected. If [MOT_TYPE] is not CUSTOM, any other setting will be ignored.

This command is only acceptable in Programming Mode.

```

<COMMAND CSP>
Get/Set Custom Search Settings
Controller → Radio
CSP, [SRCH_INDEX] [\r]
CSP, [SRCH_INDEX], [NAME], [LIMIT_L], [LIMIT_H], [STP], [MOD], [ATT], [DLY], [RSV],
[HLD], [LOUT], [C-CH], [RSV], [RSV], [QUICK_KEY], [START_KEY], [RSV], [NUMBER_TAG],
[AGC_ANALOG], [AGC_DIGITAL], [P25WAITING] [\r]
Radio → Controller
CSP, [NAME], [LIMIT_L], [LIMIT_H], [STP], [MOD], [ATT], [DLY], [RSV], [HLD], [LOUT],
[C-CH], [RSV], [RSV], [QUICK_KEY], [START_KEY], [RSV], [NUMBER_TAG], [AGC_ANALOG],
[AGC_DIGITAL], [P25WAITING] [\r]
CSP,OK[\r]

```

```

[SRCH_INDEX]      : Index                (1-9,0 means 10)
[NAME]            : Name                  (max.16char)
[LIMIT_L]         : Lower Limit Frequency  (250000-13000000)
[LIMIT_H]         : Upper Limit Frequency  (250000-13000000)
[STP]             : Search Step
                  AUTO : AUTO           833   : 8.33k     2000   : 20k
                  500   : 5k             1000   : 10k      2500   : 25k
                  625   : 6.25k        1250   : 12.5k    5000   : 50k
                  750   : 7.5 k         1500   : 15k      10000  : 100k
[MOD]             : Modulation            (AUTO/AM/FM/NFM/WFM/FMB)
[ATT]             : Attenuation           (0:OFF / 1:ON)
[DLY]             : Delay Time            (-10,-5,-2,0,1,2,5,10,30)
[HLD]             : System Hold Time      (0-255)
[LOUT]           : Lockout                (0:Unlocked / 1:Lockout)
[C-CH]           : Control Channel Only   (0:OFF / 1:ON)
[QUICK_KEY]      : Quick Key              (0 - 99 / .(dot) )
[START_KEY]      : Startup Configuration Key (0 - 9/ .(dot))
[NUMBER_TAG]     : Number tag             (0-999 / NOE)
[AGC_ANALOG]     : AGC Setting for Analog Audio (0:OFF / 1:ON)
[AGC_DIGITAL]    : AGC Setting for Digital Audio (0:OFF / 1:ON)
[P25WAITING]     : P25 Waiting time(0,100,200,300, .... , 900,1000)

```

Get/Set Custom Search Settings.

In set command, only ", " parameters are not changed.

The set command is aborted if any format error is detected.

This command is only acceptable in Programming Mode.

```

<COMMAND WXS>
Get/Set Weather Settings
Controller → Radio
WXS[\r]
WXS, [DLY], [ATT], [ALT_PRI], [RSV], [AGC_ANALOG], [RSV] [\r]
Radio → Controller
WXS, [DLY], [ATT], [ALT_PRI], [RSV], [AGC_ANALOG], [RSV] [\r]
WXS,OK[\r]

[DLY]          : Delay Time                (-10,-5,-2,0,1,2,5,10,30)
[ATT]          : Attenuation                (0:OFF / 1:ON)
[ALT_PRI]     : Weather Alert Priority      (0:OFF / 1:ON)
[AGC_ANALOG] : AGC Setting for Analog Audio (0:OFF / 1:ON)

```

Get/Set Weather Priority Settings.
This command is only acceptable in Programming Mode.

```

<COMMAND SGP>
Get/Set SAME Group Settings
Controller → Radio
SGP, [SAME_INDEX] [\r]
SGP, [SAME_INDEX], [NAME], [FIPS1], [FIPS2], [FIPS3], [FIPS4], [FIPS5], [FIPS6],
[FIPS7], [FIPS8] [\r]
Radio → Controller
SGP, [NAME], [FIPS1], [FIPS2], [FIPS3], [FIPS4], [FIPS5], [FIPS6], [FIPS7], [FIPS8] [\r]
SGP,OK[\r]

[SAME_INDEX] : SAME Index      (1 - 5 )
[NAME]       : SAME Group Name (max.16char)
[FIPS1-8]    : FIPS Code (6digit:000000-999999, or ----- means none)

```

Get/Set SAME Group Settings.
In set command, only ", " parameters are not changed.
The set command is aborted if any format error is detected.
This command is only acceptable in Programming Mode.

```

<COMMAND TON>
Get/Set Tone-Out Settings
Controller → Radio
TON,[INDEX][\r]
TON,[INDEX],[NAME],[FRQ],[MOD],[ATT],[DLY],[ALT],[ALTL],[TONE_A],[RSV],
[TONE_B],[RSV],[RSV],[RSV],[ALT_COLOR],[ALT_PATTERN],[AGC_ANALOG],[RSV],
[RSV][\r]
Radio → Controller
TON,[INDEX],[NAME],[FRQ],[MOD],[ATT],[DLY],[ALT],[ALTL],[TONE_A],[RSV],
[TONE_B],[RSV],[RSV],[RSV],[ALT_COLOR],[ALT_PATTERN],[AGC_ANALOG],[RSV],
[RSV][\r]
TON,OK[\r]

```

```

[INDEX]      : Index                (1-9,0 means 10)
[NAME]       : Name                  (max.16char)
[FRQ]        : Channel Frequency
[MOD]        : Modulation            (AUTO / FM / NFM)
[ATT]        : Attenuation           (0:OFF / 1:ON)
[DLY]        : Delay Time            (0,1,2,5,10,30 / INF : Infinite)
[ALT]        : Alert Tone            (0:OFF/1-9:Tone No.)
[ALTL]       : Alert Tone Level      (0:AUTO/1-15)
[TONE_A]     : Tone A Frequency
                ex.) 10000 means 1000.0Hz
                00000 means 0.0Hz
[RSV]        : Reserve Parameter     * This is always only ",".
[TONE_B]     : Tone B Frequency
[ALT_COLOR]  : Alert Light color
                (OFF,BLUE,RED,MAGENTA,GREEN,CYAN,YELLOW,WHITE)
[ALT_PATTERN]: Alert Light Pattern(0:ON / 1:Slow / 2:Fast)
[AGC_ANALOG]: AGC Setting for Analog Audio (0:OFF / 1:ON)

```

Get/Set Tone-Out Settings.
This command is only acceptable in Programming Mode.

```

<COMMAND CNT>
Get/Set LCD Contrast Settings
Controller → Radio
CNT[\r]
CNT,[CONTRAST][\r]
Radio → Controller
CNT,[CONTRAST][\r]
CNT,OK[\r]

```

```

[CONTRAST]      : LCD Contrast        (1 - 15)

```

Get/Set LCD Contrast Settings.
This command is only acceptable in Programming Mode.

<COMMAND SCN>

Get/Set Scanner Option Settings

Controller → Radio

SCN[\r]

SCN, [DISP_MODE], [RSV], [CH_LOG], [G_ATT], [RSV], [P25_LPF] [RSV], [RSV], [RSV],
[RSV], [RSV], [RSV], [RSV], [RSV], [RSV], [RSV], [RSV], [RSV], [RSV], [RSV] [\r]

Radio → Controller

SCN, [DISP_MODE], [RSV], [CH_LOG], [G_ATT], [RSV], [P25_LPF], [RSV], [RSV], [RSV],
[RSV], [RSV], [RSV], [RSV], [RSV], [RSV], [RSV], [RSV], [RSV], [RSV], [RSV] [\r]

SCN,OK[\r]

[DISP_MODE] : DISPLAY MODE (1:MODE1 / 2:MODE2 / 3:MODE3)
[CH_LOG] : Control Channel Logging (0:OFF / 1:ON / 2:Extend)
[G_ATT] : Global attenuator (0: OFF / 1: ON)
[P25_LPF] : P25 Low-Pass Filter (0: OFF / 1: ON)
[RSV] : Reserve Parameter * This is always only ",".

Get/Set Scanner Option Settings

This command is only acceptable in Programming Mode.

<COMMAND VOL>

Get/Set Volume Level Settings

Controller → Radio

VOL[\r]

VOL, [LEVEL] [\r]

Radio → Controller

VOL, [LEVEL] [\r]

VOL,OK[\r]

[LEVEL] : Volume Level (0 - 15)

<COMMAND SQL>

Get/Set Squelch Level Settings

Controller → Radio

SQL[\r]

SQL, [LEVEL] [\r]

Radio → Controller

SQL, [LEVEL] [\r]

SQL,OK[\r]

[LEVEL] : Squelch Level (0:OPEN / 1-14 / 15:CLOSE)

<COMMAND P25>

Get/Set APCO Data Settings

Controller → Radio

P25[\r]

Radio → Controller

P25, [RSV], [RSV], [ERR_RATE] [\r]

[ERR_RATE] : Error Rate (from 0 to 99)

```

<COMMAND DBC>
Get/Set Default Band Coverage Settings
Controller → Radio
DBC, [BNAD_NO] [\r]
DBC, [BNAD_NO], [STEP], [MOD] [\r]

```

```

Radio → Controller
DBC, [STEP], [MOD] [\r]
DBC, OK [\r]

```

```

[BAND_NO]          : Band No (1-31)
                   : Band number of band coverage
[STP]              : Search Step
    500   : 5k      625   : 6.25k   750   : 7.5 k
    833   : 8.33k  1000  : 10k     1250  : 12.5k
    1500  : 15k    2000  : 20k     2500  : 25k
    5000  : 50k    10000 : 100k
[MOD]             : Modulation      (AM / NFM / FM / WFM / FMB)

```

This command is only acceptable in Programming Mode.

```

<COMMAND GDO>
Get/Set GPS Disp Option
Controller → Radio
GDO [\r]
GDO, [DISP_MODE], [UNIT], [TIME_FORMAT], [TIME_ZONE], [POS_FORMAT] [\r]
Radio → Controller
GDO, [DISP_MODE], [UNIT], [TIME_FORMAT], [TIME_ZONE], [POS_FORMAT] [\r]
GDO, OK [\r]

```

```

[DISP_MODE] : Display GPS Mode
              ( 0:ETA / 1:Clock / 2:Elevation / 3:Speed / 4:Location )
[UNIT]       : Distance Unit      ( 0: mile / 1: km )
[TIME_FORMAT]: Time Format         ( 0: 12 H / 1: 24H)
[TIME_ZONE]  : Time Zone (-14.0/-13.5/.../-0.5/0.0/0.5/.../13.5/14.0)
              ex) "-14.0" means "- 14.0 H".
[POS_FORMAT]: Position Format      ( DMS / DEG )

```

This command is only acceptable in Programming Mode.

```

<COMMAND BSP>
Get/Set Band Scope System Settings
Controller → Radio
BSP[\r]
BSP, [FRQ], [STP], [SPN], [MAX_HOLD] [\r]
Radio → Controller
BSP, [FRQ], [STP], [SPN], [MAX_HOLD] [\r]
BSP,OK[\r]
    [FRQ]                : Center Frequency
    [STP]                : Search Step
        500      : 5k          625      : 6.25k          750      : 7.5 k
        833      : 8.33k       1000     : 10k           1250     : 12.5k
        1500     : 15k         2000     : 20k           2500     : 25k
        5000     : 50k         10000    : 100k
    [SPN]                : Sweep Span
        0.2M,     0.4M,     0.6M,
        0.8M,     1M,       2M,
        4M,       6M,       8M,
        10M,     20M,     40M,
        60M,     80M,     100M,
        120M,    140M,    160M,
        180M,    200M,    250M,
        300M,    350M,    400M,
        450M,    500M
    [MAX_HOLD]          : Max Hold Display          (0:OFF / 1:ON)

```

Get/Set Band Scope System Settings.

In set command, only "," parameters are not changed.

The set command is aborted if any format error is detected.

This command is only acceptable in Programming Mode.

```

<COMMAND GIE>
Get Global IF exchange Frequency
Controller → Radio
GIE [\r]
Radio → Controller
GIE, [FRQ] [\r]
GIE, -1 [\r]

    [FRQ]                : IF Exchange Frequency          (250000-13000000)

```

This command is used to get Global IF exchange frequency list.

You should call this command again and again to get all global IF exchange frequencies until the scanner returns "-1".

"-1" means that no more IF exchange frequency exists.

This command is only acceptable in Programming Mode.

```
<COMMAND CIE>
Clear IF exchange Frequency
Controller → Radio
CIE, [FRQ] [\r]
Radio → Controller
CIE, OK [\r]
```

[FRQ] : IF Exchange Frequency (250000-13000000)

This command clear Frequency from Global IF exchange Frequency list.
This command is only acceptable in Programming Mode.

```
<COMMAND RIE>
Register IF exchange Frequency
Controller → Radio
RIE, [FRQ] [\r]
Radio → Controller
RIE, OK [\r]
```

[FRQ] : IF Exchange Frequency (250000-13000000)

This command register Frequency to Global IF exchange Frequency list.
This command is only acceptable in Programming Mode.

```
<COMMAND BAV>
*Get Battery Voltage

Controller → Radio
BAV [\r]
Radio → Controller
BAV, #### [\r] : A/D Value (0-1023)
```

Battery Level[V] = (3.2[V] * #### * 2) / 1023

Returns current battery voltage.
This command is for test mode.

```
<COMMAND WIN>
*Get Window Voltage
Controller → Radio
WIN [\r]
Radio → Controller
WIN, ###, [FRQ] [\r] : ### : A/D Value (0-255)
```

Returns current window voltage and its frequency.
The order of the frequency digits is from 1 GHz digit to 100 Hz digit.
This command is for test mode.

CTCSS/DCS CODE LIST

CTCSS

MODE	CODE
CTCSS 67.0Hz	64
CTCSS 69.3Hz	65
CTCSS 71.9Hz	66
CTCSS 74.4Hz	67
CTCSS 77.0Hz	68
CTCSS 79.7Hz	69
CTCSS 82.5Hz	70
CTCSS 85.4Hz	71
CTCSS 88.5Hz	72
CTCSS 91.5Hz	73
CTCSS 94.8Hz	74
CTCSS 97.4Hz	75
CTCSS 100.0Hz	76
CTCSS 103.5Hz	77
CTCSS 107.2Hz	78
CTCSS 110.9Hz	79

CTCSS 114.8Hz	80
CTCSS 118.8Hz	81
CTCSS 123.0Hz	82
CTCSS 127.3Hz	83
CTCSS 131.8Hz	84
CTCSS 136.5Hz	85
CTCSS 141.3Hz	86
CTCSS 146.2Hz	87
CTCSS 151.4Hz	88
CTCSS 156.7Hz	89
CTCSS 159.8Hz	90
CTCSS 162.2Hz	91
CTCSS 165.5Hz	92
CTCSS 167.9Hz	93
CTCSS 171.3Hz	94
CTCSS 173.8Hz	95
CTCSS 177.3Hz	96

CTCSS 179.9Hz	97
CTCSS 183.5Hz	98
CTCSS 186.2Hz	99
CTCSS 189.9Hz	100
CTCSS 192.8Hz	101
CTCSS 196.6Hz	102
CTCSS 199.5Hz	103
CTCSS 203.5Hz	104
CTCSS 206.5Hz	105
CTCSS 210.7Hz	106
CTCSS 218.1Hz	107
CTCSS 225.7Hz	108
CTCSS 229.1Hz	109
CTCSS 233.6Hz	110
CTCSS 241.8Hz	111
CTCSS 250.3Hz	112
CTCSS 254.1Hz	113

DCS

MODE	CODE
DCS 023	128
DCS 025	129
DCS 026	130
DCS 031	131
DCS 032	132
DCS 036	133
DCS 043	134
DCS 047	135
DCS 051	136
DCS 053	137
DCS 054	138
DCS 065	139
DCS 071	140
DCS 072	141
DCS 073	142
DCS 074	143
DCS 114	144
DCS 115	145
DCS 116	146
DCS 122	147
DCS 125	148
DCS 131	149
DCS 132	150
DCS 134	151
DCS 143	152
DCS 145	153
DCS 152	154
DCS 155	155
DCS 156	156
DCS 162	157
DCS 165	158
DCS 172	159
DCS 174	160
DCS 205	161
DCS 212	162
DCS 223	163
DCS 225	164
DCS 226	165

DCS 243	166
DCS 244	167
DCS 245	168
DCS 246	169
DCS 251	170
DCS 252	171
DCS 255	172
DCS 261	173
DCS 263	174
DCS 265	175
DCS 266	176
DCS 271	177
DCS 274	178
DCS 306	179
DCS 311	180
DCS 315	181
DCS 325	182
DCS 331	183
DCS 332	184
DCS 343	185
DCS 346	186
DCS 351	187
DCS 356	188
DCS 364	189
DCS 365	190
DCS 371	191
DCS 411	192
DCS 412	193
DCS 413	194
DCS 423	195
DCS 431	196
DCS 432	197
DCS 445	198
DCS 446	199
DCS 452	200
DCS 454	201
DCS 455	202
DCS 462	203
DCS 464	204

DCS 465	205
DCS 466	206
DCS 503	207
DCS 506	208
DCS 516	209
DCS 523	210
DCS 526	211
DCS 532	212
DCS 546	213
DCS 565	214
DCS 606	215
DCS 612	216
DCS 624	217
DCS 627	218
DCS 631	219
DCS 632	220
DCS 654	221
DCS 662	222
DCS 664	223
DCS 703	224
DCS 712	225
DCS 723	226
DCS 731	227
DCS 732	228
DCS 734	229
DCS 743	230
DCS 754	231

FONT DATA

Character pattern of 8 x 16 dot

This character pattern is Large Font.

*In this document, characters of these areas are described as normal characters.

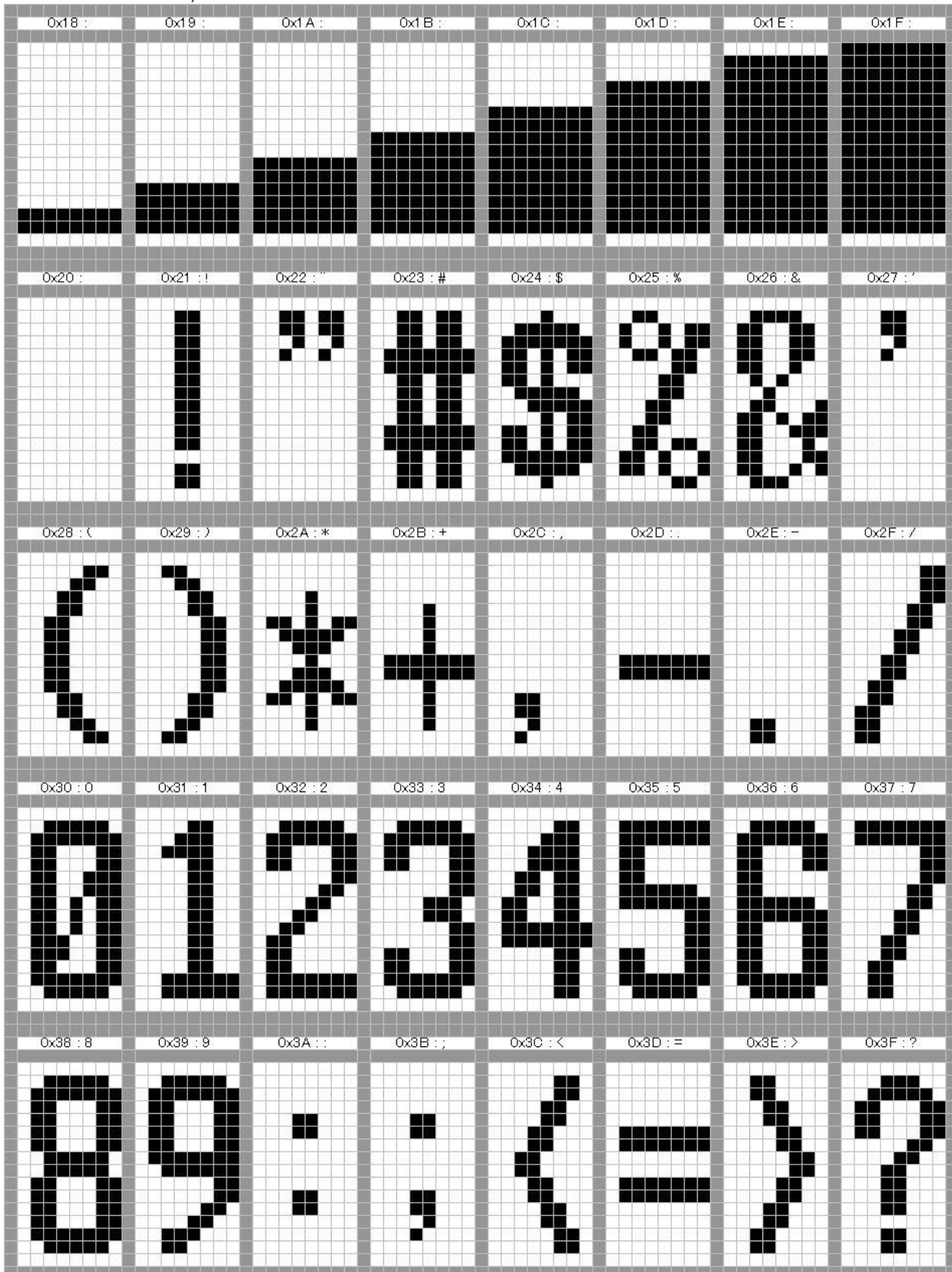



0x68 : h	0x69 : I	0x6A : j	0x6B : k	0x6C : l	0x6D : m	0x6E : n	0x6F : o
0x70 : p	0x71 : q	0x72 : r	0x73 : s	0x74 : t	0x75 : u	0x76 : v	0x77 : w
0x78 : x	0x79 : y	0x7A : z	0x7B : {	0x7C :	0x7D : }	0x7E : ~	0x7F :
0x80 : █	0x81 : ↑	0x82 : ↓	0x83 :	0x84 : ↙	0x85 : ↘	0x86 : ↙	0x87 : ↘
0x88 :	0x89 : ↙	0x8A : ↘	0x8B :	0x8C :	0x8D : ↙	0x8E : ↘	0x8F : ↙

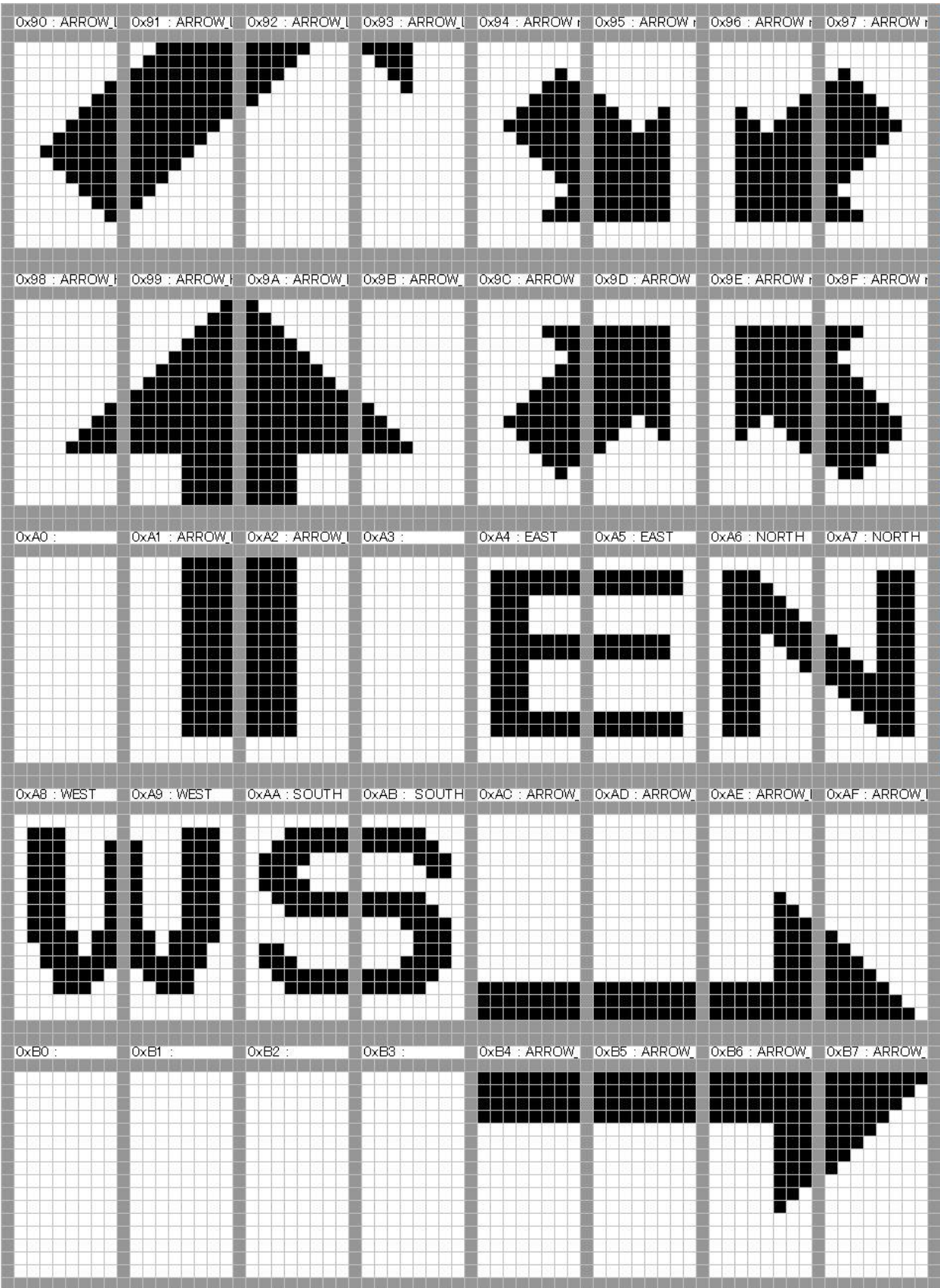

0xB8 : ARROW_	0xB9 : ARROW_	0xBA : ARROW_	0xBB :	0xBC : ARROW	0xBD : ARROW	0xBE : ARROW	0xBF : ARROW
0xC0 : ARROW_	0xC1 : ARROW_	0xC2 : ARROW_	0xC3 : ARROW_	0xC4 : ARROW	0xC5 : ARROW	0xC6 : ARROW	0xC7 : ARROW
0xC8 : ARROW_	0xC9 : ARROW_	0xCA : ARROW_	0xCB : ARROW_	0xCC :	0xCD :	0xCE :	0xCF :
0xD0 : ARROW_	0xD1 : ARROW_	0xD2 : ARROW_	0xD3 : ARROW_	0xD4 : FUNC	0xD5 : BAR R1	0xD6 : BAR R2	0xD7 : BAR R3
0xD8 : ARROW_	0xD9 : ARROW_	0xDA : ARROW_	0xDE : ARROW_	0xDC : BAR R4	0xDD : L/O	0xDE : L/O	0xDF : L/O

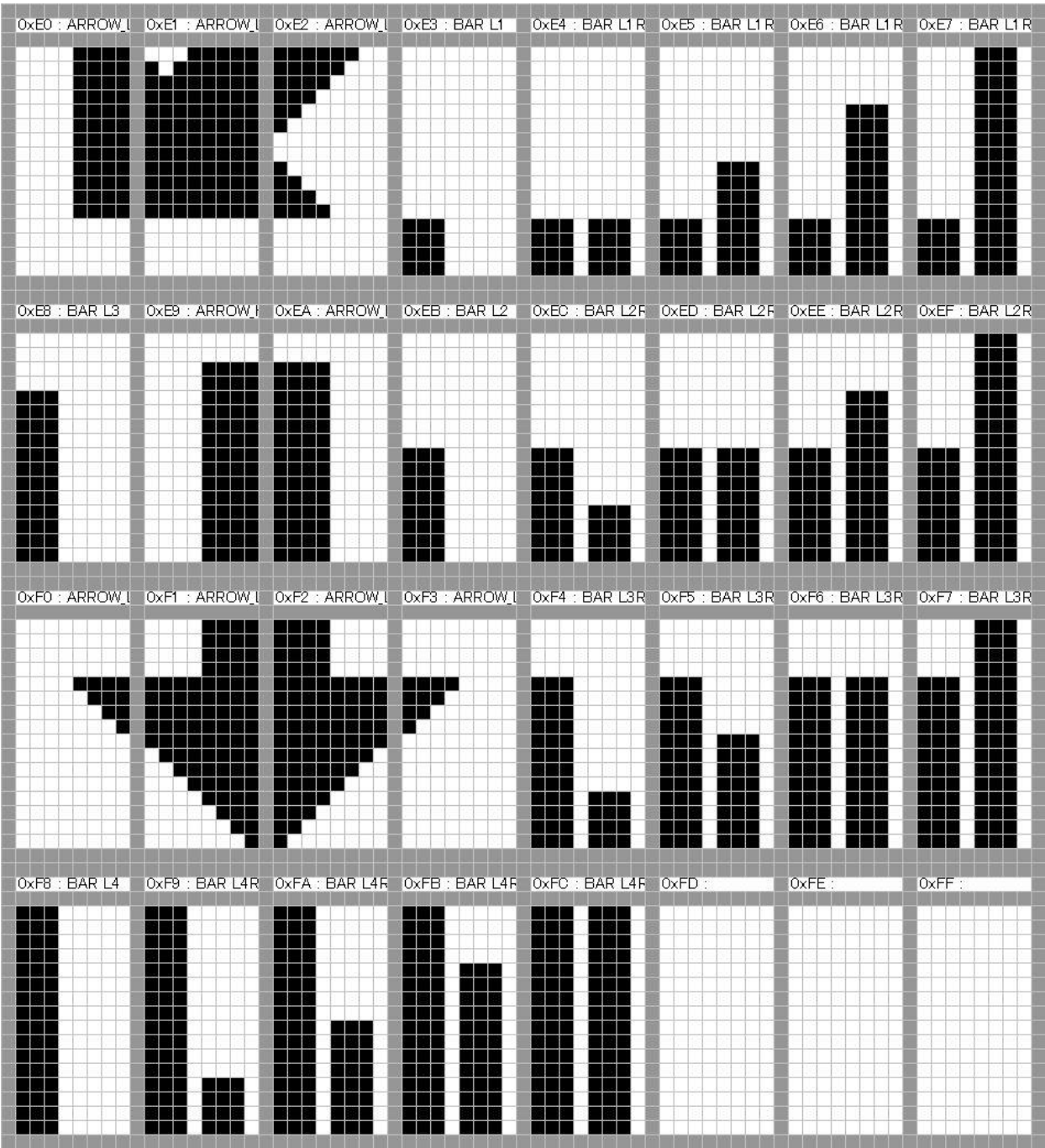

Character pattern of 8 x 8 dot

This character pattern is Small Font.

0x20 :	0x21 : !	0x22 : "	0x23 : #	0x24 : \$	0x25 : %	0x26 : &	0x27 : '
0x28 : (0x29 :)	0x2A : *	0x2B : +	0x2C : ,	0x2D : -	0x2E : .	0x2F : /
0x30 : 0	0x31 : 1	0x32 : 2	0x33 : 3	0x34 : 4	0x35 : 5	0x36 : 6	0x37 : 7
0x38 : 8	0x39 : 9	0x3A : :	0x3B : ;	0x3C : <	0x3D : =	0x3E : >	0x3F : ?
0x40 : @	0x41 : A	0x42 : B	0x43 : C	0x44 : D	0x45 : E	0x46 : F	0x47 : G
0x48 : H	0x49 : I	0x4A : J	0x4B : K	0x4C : L	0x4D : M	0x4E : N	0x4F : O
0x50 : P	0x51 : Q	0x52 : R	0x53 : S	0x54 : T	0x55 : U	0x56 : V	0x57 : W
0x58 : X	0x59 : Y	0x5A : Z	0x5B : [0x5C : \	0x5D :]	0x5E : ^	0x5F : _
0x60 : `	0x61 : a	0x62 : b	0x63 : c	0x64 : d	0x65 : e	0x66 : f	0x67 : g
0x68 : h	0x69 : i	0x6A : j	0x6B : k	0x6C : l	0x6D : m	0x6E : n	0x6F : o

0x70 : p	0x71 : q	0x72 : r	0x73 : s	0x74 : t	0x75 : u	0x76 : v	0x77 : w
0x78 : x	0x79 : y	0x7A : z	0x7B : l	0x7C : j	0x7D : j	0x7E : "	0x7F :
0x80 : ■	0x81 : l	0x82 : ↓	0x83 : Battery L	0x84 : Battery L	0x85 : Key Pad	0x86 : Key Pad	0x87 : Close Ca
0x88 : Close Ca	0x89 : Close Ca	0x8A : Close Ca	0x8B : Function	0x8C : Priority C	0x8D : HOLD	0x8E : HOLD	0x8F : HOLD
0x90 : HOLD	0x91 : Data Skip	0x92 : Data Skip	0x93 : Data Skip	0x94 : Data Skip	0x95 : Lock Out	0x96 : Lock Out	0x97 : Lock Out
0x98 : AM	0x99 : AM	0x9A : AM	0x9B : FM	0x9C : FM	0x9D : NFM	0x9E : NFM	0x9F : WFM
0xA0 : WFM	0xA1 : Priority M	0xA2 : Priority M	0xA3 : Attenuat	0xA4 : Attenuat	0xA5 : Attenuat	0xA6 : Signal Le	0xA7 : Signal Le
0xA8 : Signal Le	0xA9 : Signal Le	0xAA : Signal Le	0xAB : Signal Le	0xAC : Signal Le	0xAD : Signal Le	0xAE : Active C	0xAF : Active C
0xB0 : Active C	0xB1 : Volume/	0xB2 : Volume/	0xB3 : Volume/	0xB4 : Active C	0xB5 : CC DND	0xB6 : CC DND	0xB7 : CC DND
0xB8 : CC DND	0xB9 : FMB	0xBA : FMB	0xBB : MUTE	0xBC : MUTE	0xBD :	0xBE :	0xBF :

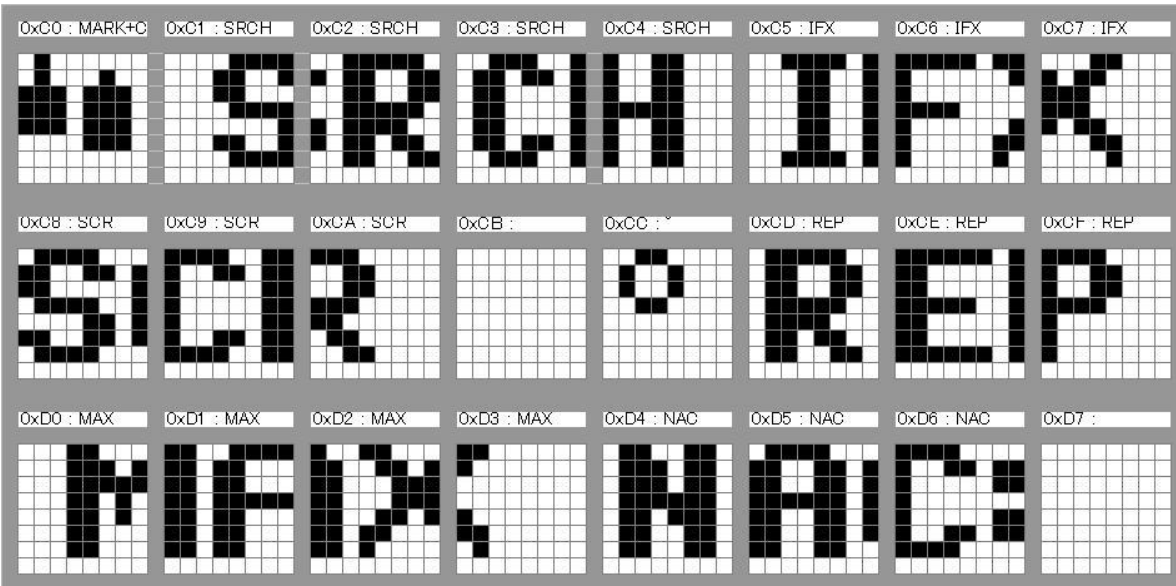

Menu tree

BCD396XT main menu

- [Program System](#)
- [Program Location](#)
- [Srch/CloCall Opt](#)
- [Search for...](#)
- [Close Call](#)
- [Priority Scan](#)
- [WX Operation](#)
- [Tone-Out for...](#)
- [Wired Clone](#)
- [Settings](#)

Using the menu

- To open the menu, tap **MENU** .
- Turn the **SELECT-VOLUME-SQUELCH** knob to move the cursor and highlight menu items. The currently highlighted item appears in reversed-out text.
- To select the highlighted item or confirm an option setting, tap **E-YES** or press down on the **SELECT-VOLUME-SQUELCH** knob.
- To cancel an option setting, press **NO** .
- To go back one level in the menu, tap **MENU** .
- To exit the menu, press **LOCKOUT** . The scanner goes back to the operating mode it was in before you entered the menu.

This page applies to the following scanner(s): [BCD396XT Users Guide](#)

Keys and their functions

- [Key Overview](#)
- [Operating the controls](#)
 - [Using the FUNCTION button](#)
- [Key functions in different operation modes](#)
- [Locking the Keypad](#)

Key Overview

The diagram below shows the keys and what they are called throughout the guide:



Operating the controls

Each button has at least two different actions which you control using the key combinations explained below.

- *Tap* : press the button and release it immediately
- *Double tap* : press the button twice, as quickly as possible (within 1 second)
- *Press & hold* : press the button and keep it pressed for at least 2 seconds before releasing it
- **FUNCTION** + *tap* : press and release **FUNCTION** , then tap the button
- **FUNCTION** + *Double tap* : press and release **FUNCTION** , then double tap the button
- **FUNCTION** + *Press & hold* : press and release **FUNCTION** , then press and

hold the button

Using the **FUNCTION** button

When you tap **FUNCTION**, the scanner remembers the **FUNCTION** + key combination for the next 3 seconds; during this time, it displays an *F* icon at the top of the screen.

If you want the scanner to maintain the **FUNCTION** + key combination longer, press & hold **FUNCTION**. The scanner remembers the **FUNCTION** + key combination until the next time you tap **FUNCTION**; during this time, it displays *Function Key Holding* and flashes the *F* icon at the top of the screen.

Key functions in different operation modes

The keys have different functions in each operation mode:

- [Scan and Search mode key functions](#)
- [Hold mode key functions](#)
- [Close Call mode key functions](#)
- [Priority Scan mode information](#)
- [GPS mode key functions](#)
- [Tone Out mode key functions](#)
- [Band Scope mode key functions](#)
- [Available functions in Key Safe mode](#)

Locking the Keypad

You can lock the keypad to prevent accidental interruptions of the scanner's current operation.

- To lock the keypad, press **FUNCTION** + tap **BACKLIGHT** . The scanner display shows *Keypad Lock On* and turns on the keypad lock icon in the upper left corner.
- All keys are disabled except for **HOLD** , **BACKLIGHT** , and **SELECT-VOLUME-SQUELCH** (Volume level only)
- To unlock the keypad, press **FUNCTION** + tap **BACKLIGHT** . The scanner display shows *Keypad Lock Off* and turns off the keypad lock icon.

This page applies to the following scanner(s): [BCD396XT](#) [BC346XT](#) [Users Guide](#)

Setting up the hardware

To determine whether the information on this page applies to your scanner, see the tags at the bottom of the page.

- [Setting up the hardware](#)
 - [Install the batteries](#)
 - [Connect the antenna](#)
 - [Attach the belt clip](#)

What's included

Inside the box you should find:

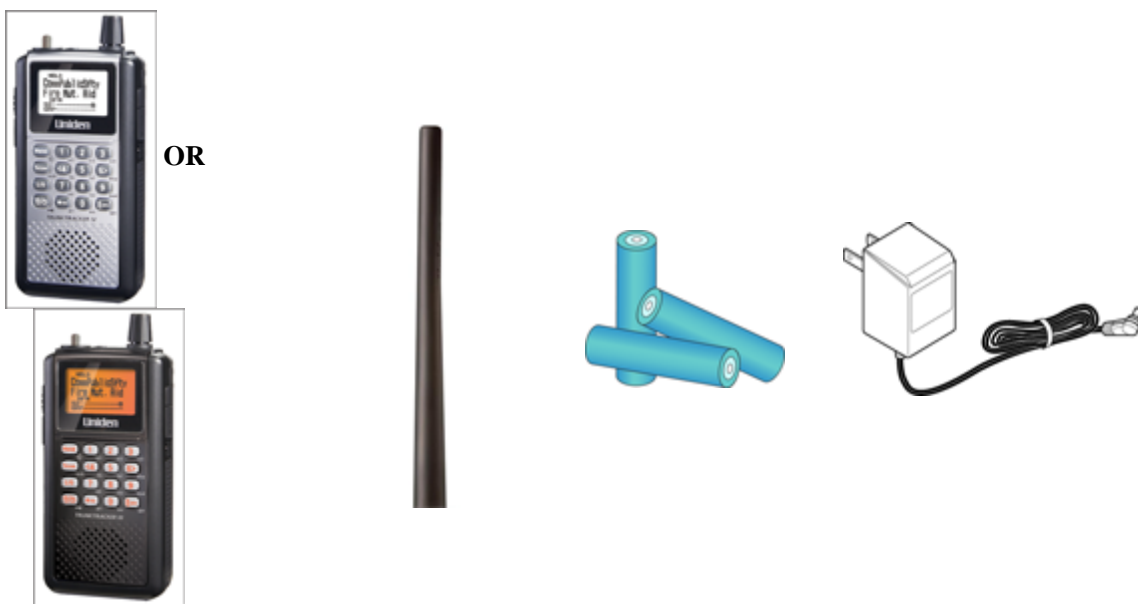

BCD396XT or BC346XT* *handheld trunking scanner	SMA antenna	NiMH rechargeable batteries (3)	AC adapter
--	--------------------	--	-------------------

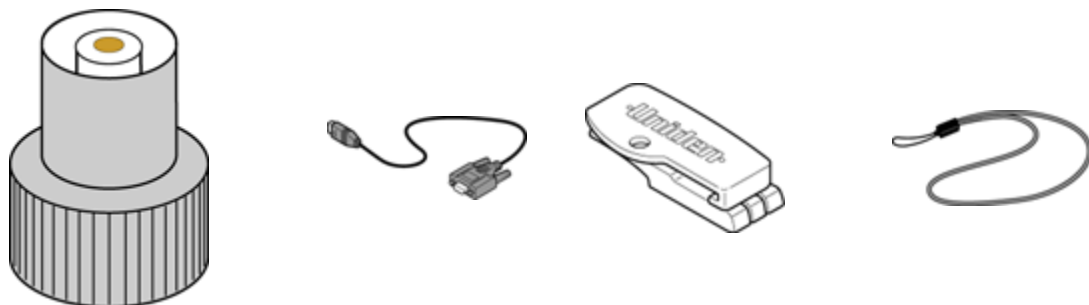

SMA-to-BNC adapter for external antennas	Data transfer cable	Belt clip	Wrist strap
---	--------------------------------	------------------	--------------------

The CD contains a static version of the manual that you can use offline. The cover for the battery compartment might be packed separately, also.

If any of these pieces are missing or damaged, [contact customer service](#) immediately. Never use damaged equipment.

Install the batteries

Your scanner can use either regular alkaline batteries or rechargeable nickel-metal hydride (NiMH) batteries. The batteries that came with your scanner are rechargeable NiMH.

To install the batteries,

1. Remove the cover from the battery compartment.
2. Make sure that the charge switch is set to the correct battery type:
 - o Use the *Alkaline* setting for any regular or non-rechargeable battery
 - o Use the *NiMH* setting for any rechargeable battery
3. Make sure the polarity (plus and minus) of each battery matches the diagram inside the compartment.
4. Replace the battery compartment cover.

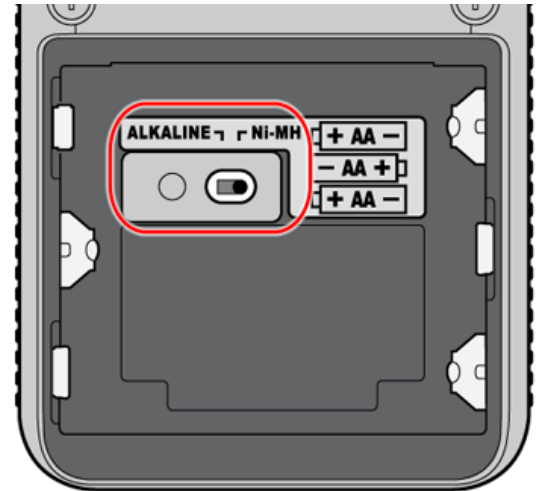

Connect the antenna



To connect the antenna, just screw it onto the SMA connector at the top of the scanner.

If you want to use an external antenna, attach the included SMA/BNC adapter to the scanner's SMA connector.

Then, connect your external antenna to the BNC connector.

Note: Always use 50- or 75-ohm, RG-58, or RG-8, coaxial cable and the supplied SMA/BNC adapter to connect an outdoor antenna. If the antenna is over 50 feet from the scanner, use RG-8 low-loss dielectric coaxial cable. Cable loss increases with higher frequency.

Attach the belt clip

Hold the belt clip with the logo facing you and the hinge facing the top of the scanner. Place the clip over the post, and slide the belt clip straight up until you hear it click into place.

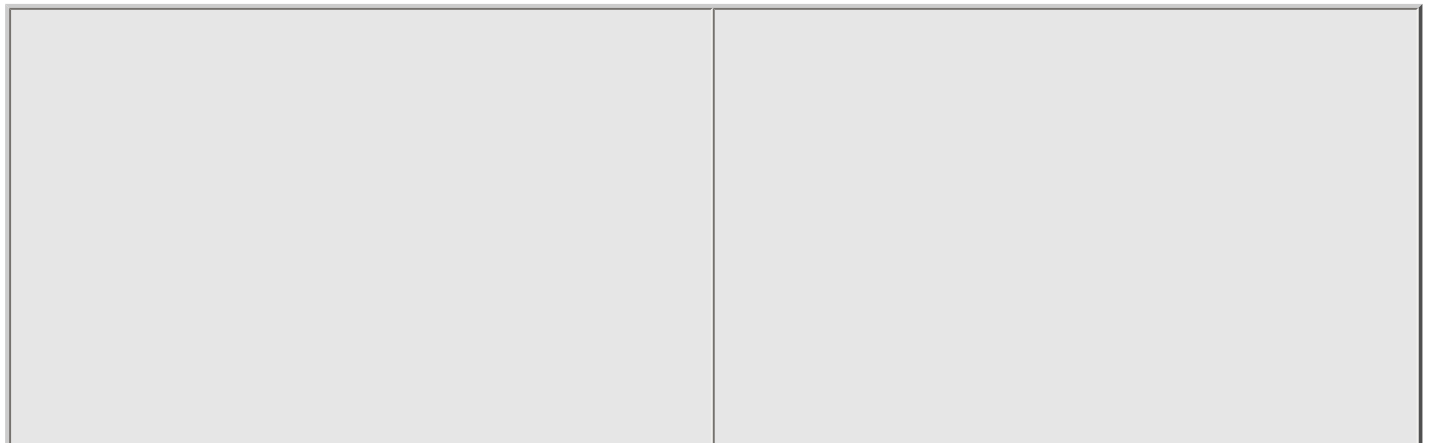

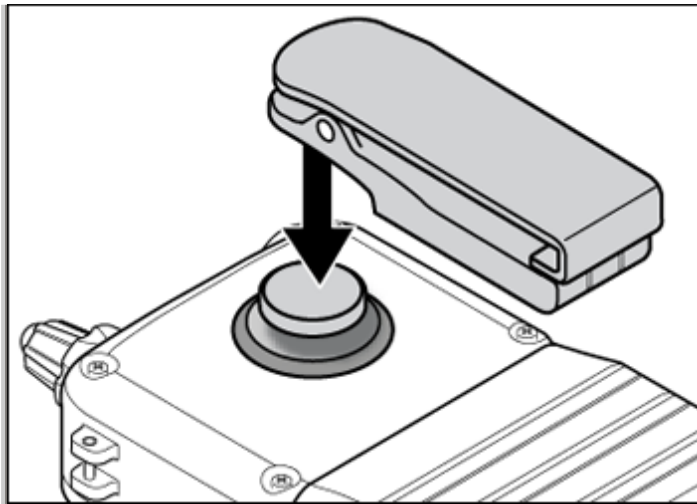

Place the clip over the post.

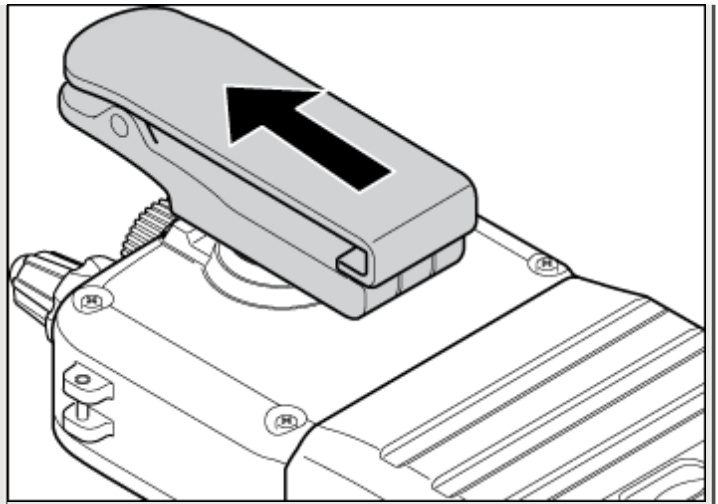

Slide the clip up into place.

To remove the belt clip

Rotate the scanner so the scanner is bottom-side up. Then slide the scanner straight up until it comes free from the belt clip.

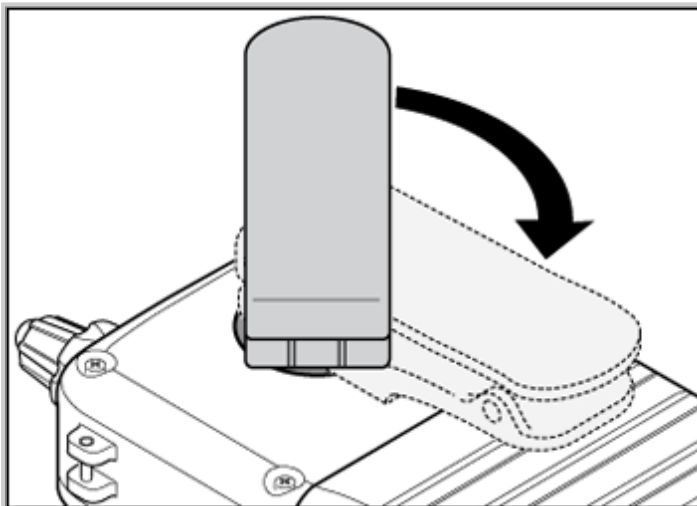

Rotate the scanner 180 degrees.

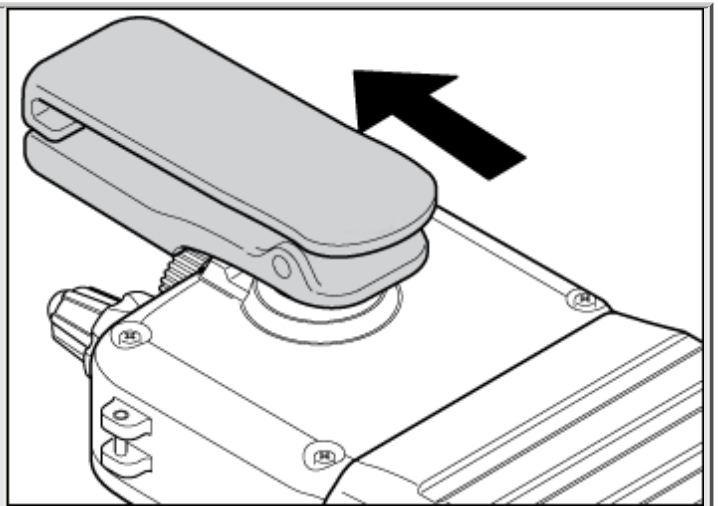

Slide the scanner up and off the belt clip.

This page applies to the following scanner(s): [BCD396XT BC346XT Users Guide](#)

Connecting a GPS receiver

To determine whether the information on this page applies to your scanner, see the tags at the bottom of the page.

- [Compatible GPS receivers](#)
- [Configuring your scanner](#)
- [Connecting the receiver](#)
- [Troubleshooting](#)

Compatible GPS receivers

You can connect your scanner to any GPS receiver that meets the following criteria:

- Outputs NMEA-0183 v3.01-compliant location data
- Outputs both the Global Positioning System Fix (*GGA*) and Recommended Minimum Specific GNSS (*RMC*) data sentences
- Provides a serial data (RS-232) connection

Configuring your scanner

1. Go to the [Settings](#) menu and select *Set Serial Port* .
2. Select *4800* bps for the baud rate.

Connecting the receiver

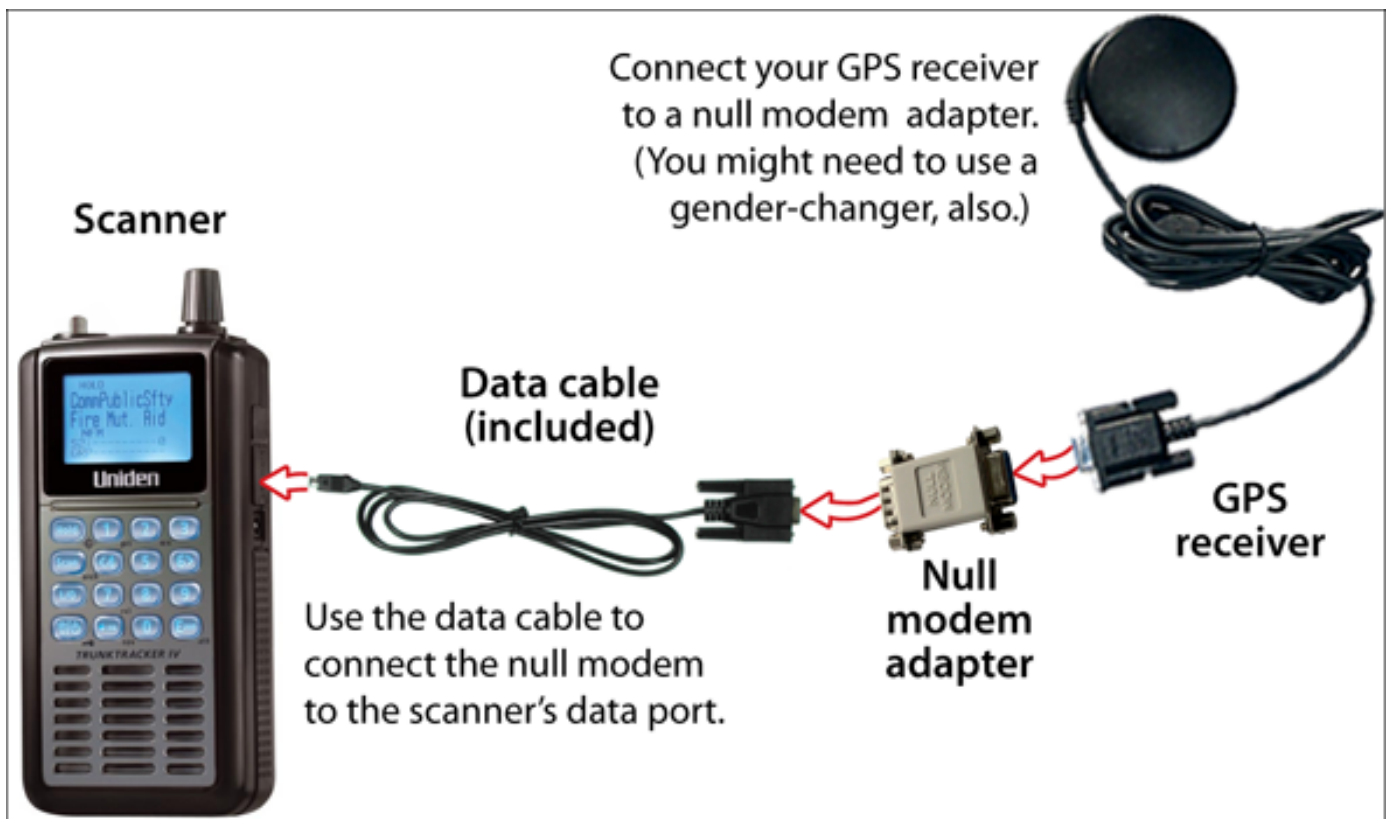

1. Connect your GPS receiver to a *null modem* adapter or cable.
2. Connect the data cable that was supplied with your scanner to the null modem.
3. *The data cable has a DE-9 socket (female) connector. To connect to the data cable, you need a DE-9 plug (male) connector. (DE-9 connectors are often called *DB-9* connectors.)
4. *Depending on your GPS connection and your null modem, you might need a *gender changer* and/or a DB-25-to-DE-9 adapter.
5. Connect the data cable to the scanner's data port.
6. When the scanner recognizes the GPS input, it displays a confirmation message and shows the GPS icon on the display.
7. *If the GPS receiver does not have a lock on the satellites, the scanner displays *Searching for Satellite* .

Troubleshooting

If you can't get the scanner to recognize the GPS receiver:

- Check the cables. Make sure you have exactly one [null modem](#) (either a cable or an adapter) somewhere in the connection: a *straight-through* connection will not work.
- Check the receiver's baud rate. Most compatible GPS receivers use a baud rate of 4800 bps, but it's possible your receiver is using a non-standard baud rate. Set the scanner's baud rate to match the GPS receiver's.

If the scanner recognizes the GPS receiver but doesn't lockout systems as you expected:

- Make sure the GPS receiver has a lock on the satellites.
- Check the location configuration for the sites and channel groups in the system.
 1. For each site or channel group, go to the [Set LocationInfo](#) menu.
 2. Check the range, latitude, and longitude settings to make sure they are correct.
 3. Make sure the *Set GPS Enable* option is set to *Yes* .

This page applies to the following scanner(s): [BCD396XT](#) [BC346XT](#) [Users Guide](#)

Tone Out mode

To determine whether the information on this page applies to your scanner, see the tags at the bottom of the page.

With the tone out feature, the scanner monitors up to 10 different channels for paging tones (two-tone sequential, single tone, and group tone). Normally, the scanner monitors each of the 10 channels in turn. However, if any tone-out channels share the same frequency, modulator, and attenuator settings, the scanner checks these channels simultaneously.

Configuring Tone Out channels

To configure Tone-Out channels:

1. Go to the [Tone-Out for...](#) menu.
2. Select *Tone-Out Setup* .
3. Select the Tone-Out channel (*Tone-Out 1* through *Tone-Out 10*) you want to configure.
4. Select *Set Frequencies* and choose the frequencies for this channel
5. Select *Set Tone* and program Tone A and Tone B.
6. Set any of the other properties as you prefer (they aren't required).

Required	Frequencies (Set Frequencies) Tone A and Tone B (Set Tones)
Recommended	Name (Edit Name)
Optional	Automatic Gain Control (Set Audio AGC) * Delay Time (Set Delay Time) Alert (Set Alert)

**digital scanners only*



Using Tone-Out Mode





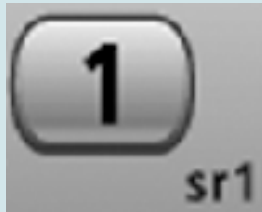

To start a Tone-Out search:

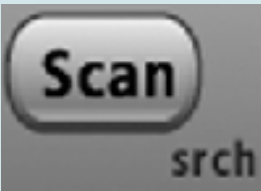
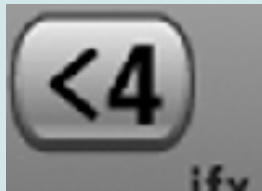
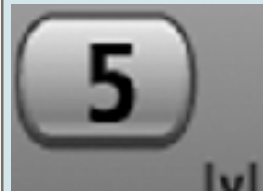

1. Tap **MENU** .
 2. Scroll down and select *Tone-Out for...*
 3. Select *Tone-Out Standby* to start the search.
- The scanner starts searching the most recently-used Tone-Out channel (and any other Tone-Out Channels that have the same frequency).
 - If you want to search a different channel, just turn the **SELECT-VOLUME-SCROLL** knob until you find the channel you want.
 - To exit Tone-Out mode, tap **SCAN** .

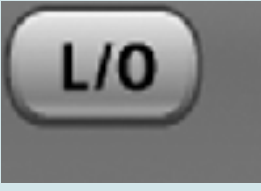
Key operation in Tone Out Mode

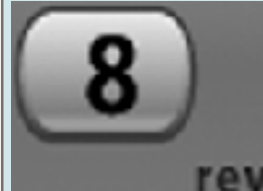
- Turn the **SELECT-VOLUME-SCROLL** knob to change the channel.
- **FUNCTION** + tap **MENU** to go to the *Tone-Out for...* menu.

Key Name (2nd operation)				
Action On	HOLD (Close Call)	1 (Search 1)	2 (Search 2)	3 (Search 3)
Tap	Enter Hold mode (the scanner opens squelch).	Enter the number on the key.		
FUNCTION + Tap	Toggle Close Call modes.	Start the search range assigned to this Search Key.		
FUNCTION + Press & hold	Enter Close Call Only mode.	NA	NA	NA

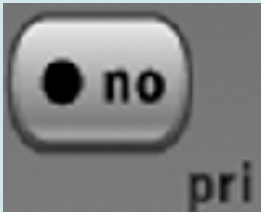
Key Name (2nd operation)				
Action on:	Scan (Search)	4 (IF exchange)	5 (Volume offset)	6 (Display mode)
Tap	Enter Scan mode.	Enter the number on the key		
FUNCTION + Tap	Display the Quick Search screen (enter Search mode).	Switch to the intermediate frequency (IF).	NA	NA
Key Name (2nd operation)				
Action on:	Lockout	7 (Attenuation)	8 (Reverse freq.)	9 (Modulation)
Tap	NA	Enter the number on the key.		
FUNCTION + Tap	NA	Toggle the attenuator state for this channel.	NA	Change the modulation.
FUNCTION + Press & hold	NA	Toggle the attenuator state for all signals.	NA	NA

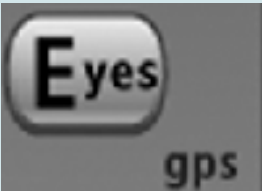
Key Name (2nd operation)				
Action on:	Backlight (Power, Lock)	No (Decimal, Priority)	0 (Weather)	Yes (Enter, GPS)
Tap	Turn on the LCD backlight.	During a system message: Cancel the message and exit that screen.	Enter the number on the key.	Edit the current Tone-Out channel.
Press & hold	Turn the scanner on or off.	NA	NA	NA
FUNCTION + Tap	Lock or unlock the keypad.	NA	Change the WX Alert Priority settings.	Enter GPS mode.
FUNCTION + Press & hold	NA	NA	Enter Weather mode.	NA

This page applies to the following scanner(s): [BCD396XT](#) [BC346XT](#) [Users Guide](#)

Close Call mode

To determine whether the information on this page applies to your scanner, see the tags at the bottom of the page.

When the scanner is in Close Call mode, it performs a close call check every 2 seconds. The scanner switches to the selected bands and searches for unusually strong signals (indicating the transmitter is probably somewhere close by). After the close call check, the scanner returns to its previous function.



In *Close Call Do Not Disturb* mode, the scanner does not perform a Close Call check if it is already receiving an audio transmission. This prevents the audio from cutting out every 2 seconds.





In *Close Call Only* mode, the scanner only performs Close Call checks.

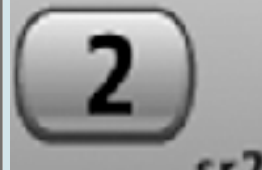
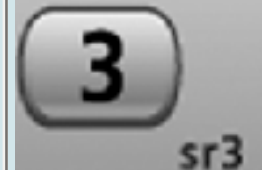

The [Close Call](#) menu lets you change the operation settings of the Close Call feature. You can change the overall Close Call options through the [Srch/CloCall Opt](#) menu.

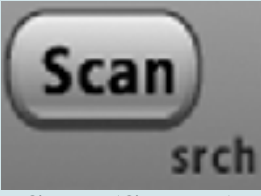
Key operation in Close Call Only mode

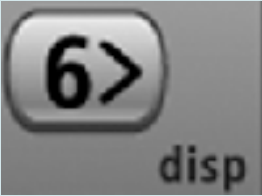
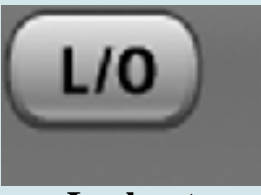
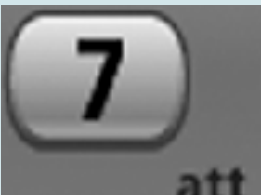
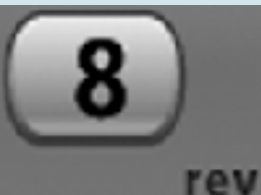
- Turn the **SELECT-VOLUME-SCROLL** knob to resume searching.
- **FUNCTION** + tap **MENU** to go to the *Close Call* menu.

Key Name (2nd operation)				
Action on:	Hold (Close Call)	1 (Search 1)	2 (Search 2)	3 (Search 3)
Tap	When the scanner detects a Close Call hit: Enter Hold mode.	Disable the Close Call band associated with this key. Tap again to enable.		

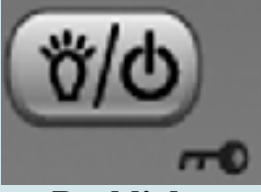
FUNCTION + Tap	Toggle Close Call mode.	Start the search assigned to this Search Key.		
Key Name (2nd operation) Action on:	 Scan (Search)	 4 (IF exchange)	 5 (Volume offset)	 6 (Display mode)
Tap	Enter Scan mode.	Disable the Close Call band associated with this key. Tap again to enable.		
FUNCTION + Tap	Display the Quick Search screen (enter Search mode).	Switch to the intermediate frequency (IF).	NA	NA
Key Name (2nd operation) Action on:	 Lockout	 7 (Attenuation)	 8 (Reverse freq.)	 9 (Modulation)
Tap	Temporarily lock out the current Close Call frequency (until you turn the scanner off).	Disable the Close Call band associated with this key. Tap again to enable.	NA	NA
Double tap	Permanently lock out the current Close Call frequency.	NA	NA	NA
Press & hold	Unlock all Close Call and Search frequencies.	NA	NA	NA
FUNCTION + Tap	Review the list of locked out IDs.	Toggle the attenuator state for this channel.	NA	Change the modulation.

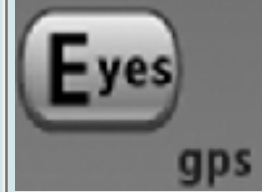
FUNCTION + Press & hold	NA	Toggle the attenuator state for all signals.	Show the reverse frequency for the current frequency. (The scanner returns to the current frequency when you release the key.)	NA
Key Name (2nd operation) Action on:	 Backlight (Power, Lock)	 No (Decimal, Priority)	 0 (Weather)	 Yes (Enter, GPS)
Tap	Turn on the LCD backlight.	During a system message: Cancel the message and exit that screen.	NA	When monitoring a Close Call frequency: store the current frequency.
Press & hold	Turn the scanner on or off.	NA	NA	NA
FUNCTION + Tap	Lock or unlock the keypad.	NA	Change the WX Alert Priority settings.	Enter GPS mode.
FUNCTION + Press & hold	NA	NA	Enter Weather mode.	NA

This page applies to the following scanner(s): [BCD396XT](#) [BC346XT](#) [Users Guide](#)

Band Scope mode

Band Scope mode is a special type of Search mode where the scanner displays the strength of any signal it finds.

- In a band scope search, the scanner starts at the lowest frequency in the range and moves up the search range.
- In *Max Hold* Search mode, the scanner displays the strongest signal that it found.
- If you manually set the mode to NFM or FM, the scanner will not reliably detect signals that are modulated in either FMB or WFM.







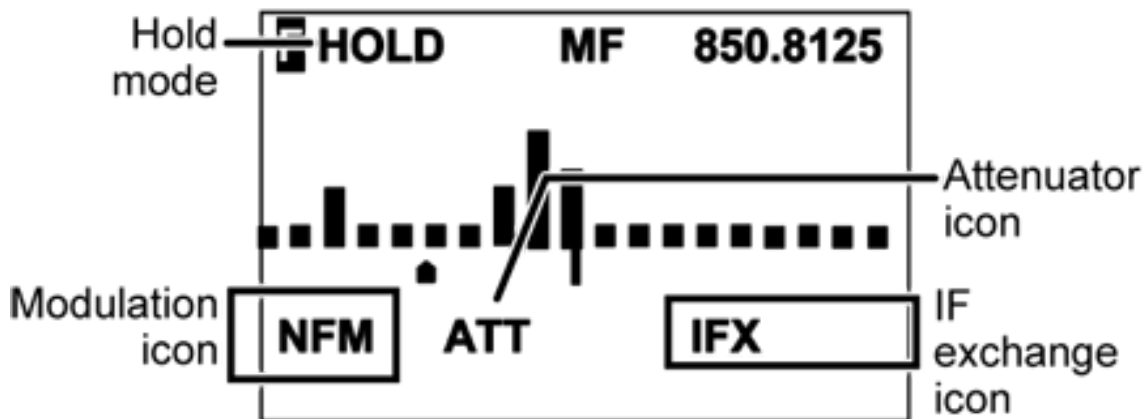
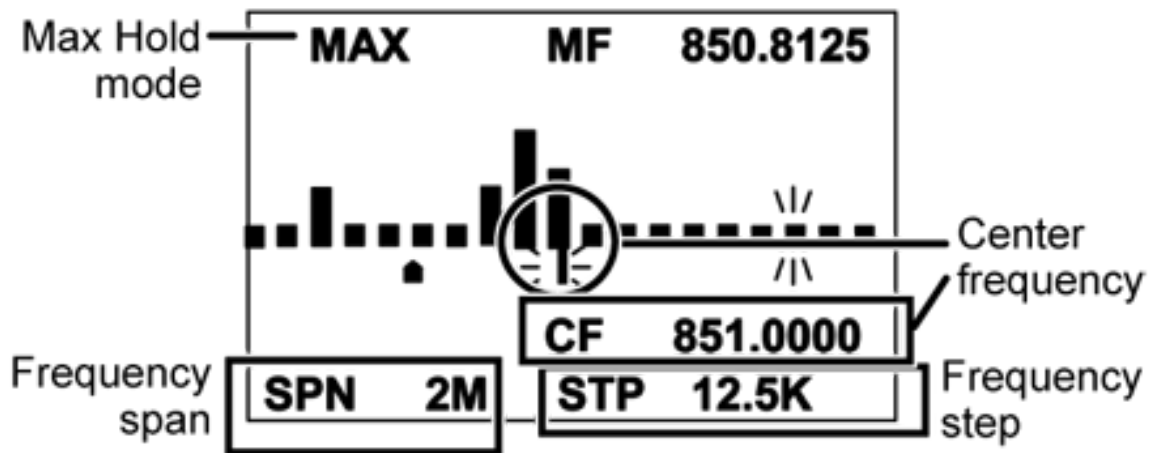
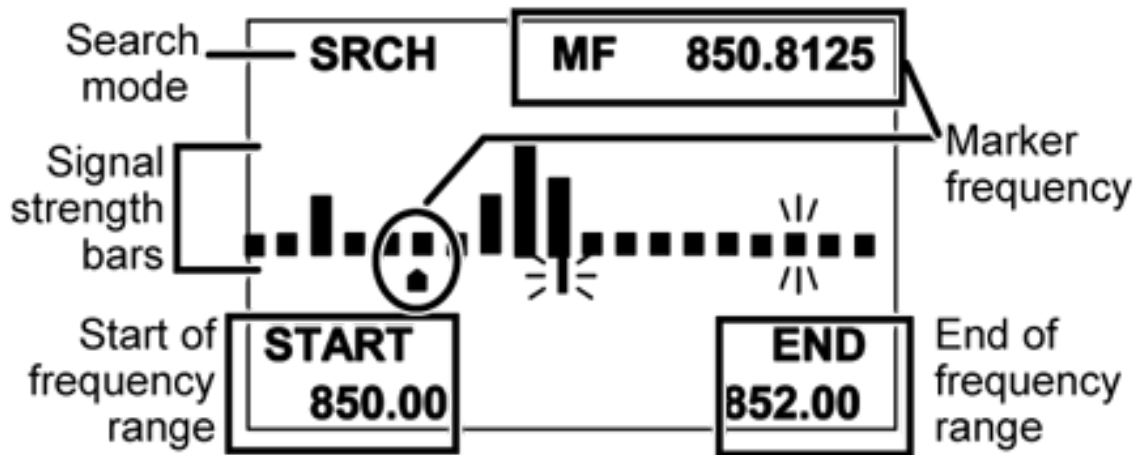

To turn on Band Scope mode:

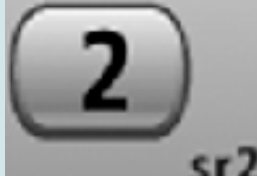
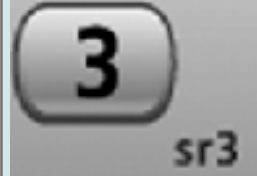

Band Scope mode is the default setting for Search Key 3. To turn on Band Scope mode, enter Search mode, then tap **FUNCTION + 3 (SR3)** . (To change the Search Key assignment, see [Search Keys#Programming Search Keys](#).)

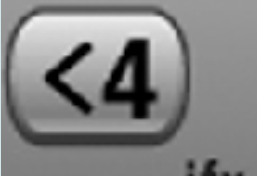
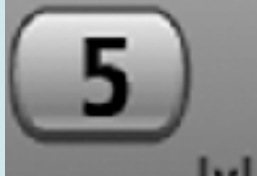
Reading the display in Band Scope mode

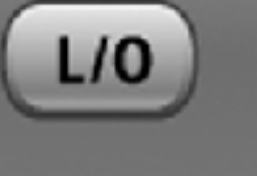
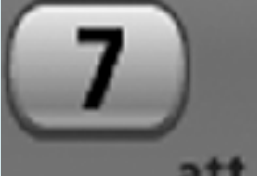
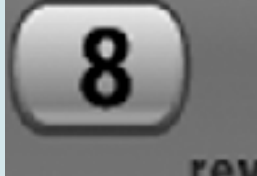

Key operation in Band Scope mode

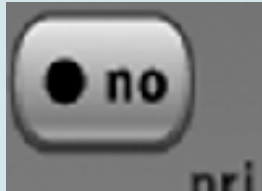
Key Name (2nd operation)				
Action on:	Hold (Close call)	1 (Search 1)	2 (Search 2)	3 (Search 3)
Tap	Enter Hold mode.	NA	NA	NA
FUNCTION + Tap	Toggle Close Call modes.	NA	NA	NA
FUNCTION + Press & hold	Enter Close Call Only mode.	NA	NA	NA
Key Name (2nd operation)				
Action on:	Scan (Search)	4 (IF exchange)	5 (Volume offset)	6 (Display mode)
Tap	Enter Scan mode.	NA	NA	NA
FUNCTION + Tap	Change the band scope search type.	NA	NA	NA
Key Name (2nd operation)				
Action on:	Lockout	7 (Attenuation)	8 (Reverse freq.)	9 (Modulation)
FUNCTION + Tap	NA	Toggle the attenuator state for the current signal.	NA	Change the modulation.

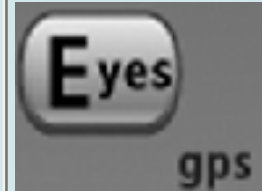
FUNCTION + Press & hold	Unlock all items regardless of type.	Toggle the attenuator state for all signals.	NA	NA
Key Name (2nd operation) Action on:	 Backlight (Power, Lock)	 No (Decimal, Priority)	 0 (Weather)	 Yes (Enter, GPS)
Tap	Turn on the LCD backlight.	During a system message: Cancel the message and exit that screen.	NA	NA
Press & hold	Turn the scanner on or off.	NA	NA	NA
FUNCTION + Tap	Lock or unlock the keypad.	NA	Change the Weather Alert Priority settings.	Enter GPS mode.
FUNCTION + Press & hold	NA	NA	Enter Weather mode.	NA

This page applies to the following scanner(s): [BCD396XT](#) [BC346XT](#)
[UsersGuide](#)

GPS mode

To determine whether the information on this page applies to your scanner, see the tags at the bottom of the page.

You must have a [compatible GPS receiver](#) connected!

- [See Also](#)
- [Reading the display in GPS mode](#)
 - [Main GPS display](#)
 - [Location alert display](#)
 - [Location review display](#)
- [Key operation in GPS mode](#)

See Also

GPS mode is only one small part of location-based scanning. For more information on using your scanner with a GPS receiver, see the following links:

[Location-based Scanning](#) contains

- an overview of why you might want to use a GPS receiver with your scanner
- an explanation of two different approaches to location-based scanning
- some information on fining antenna locations

[Programming locations](#) contains

- details on how to program locations for systems, sites, and channels
- details on how to program Points of Interest (*POI*), Dangerous Roads, and Dangerous Intersections (*Dangerous Xing*)
- information on reviewing and editing locations

[Connecting a GPS receiver](#) contains

- details on which GPS receivers are compatible
- instructions on connecting a GPS receiver
- troubleshooting tips if you can't the receiver working with the scanner

Reading the display in GPS mode

There are several displays available in GPS mode.

Main GPS display

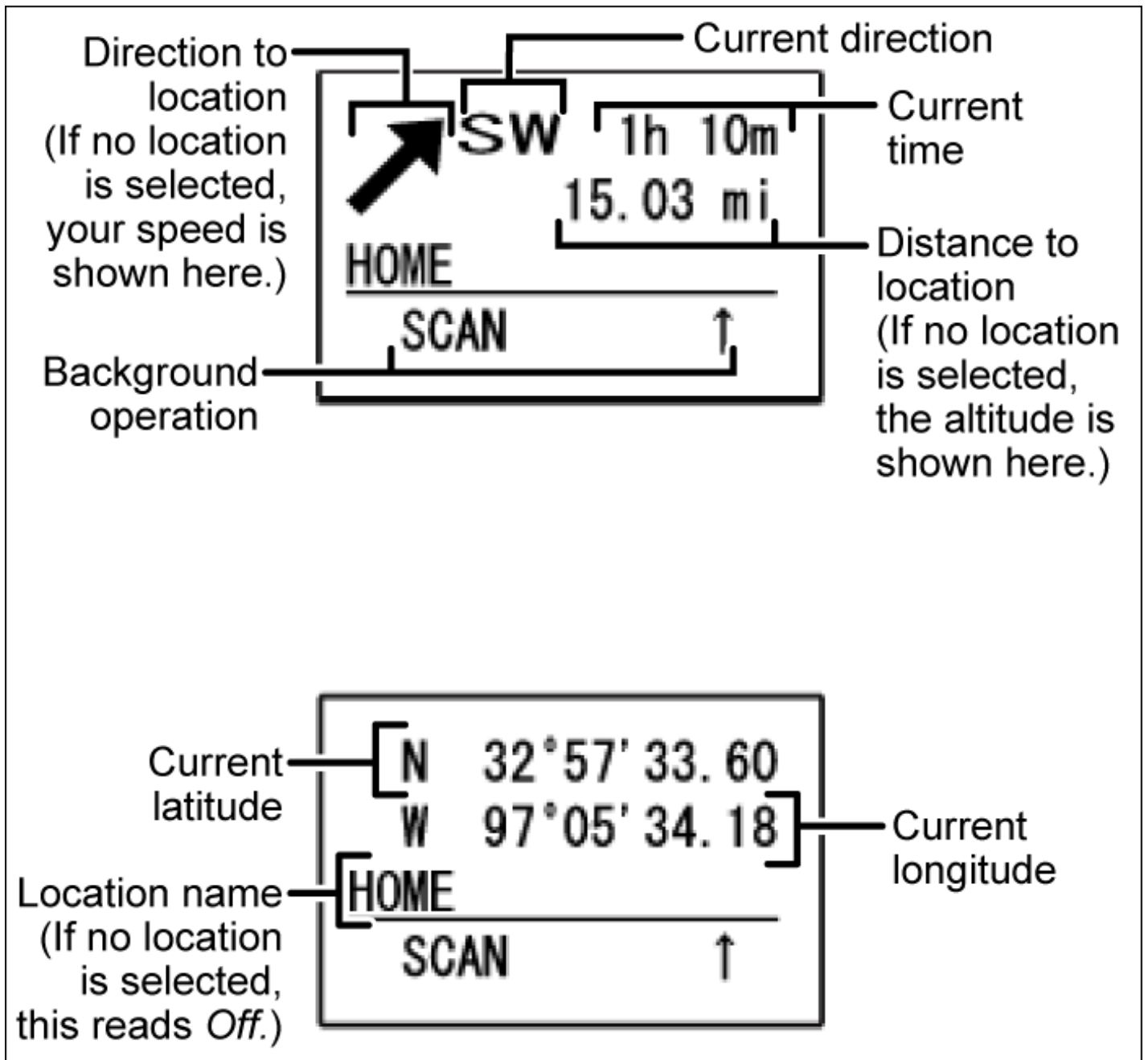

Location alert display

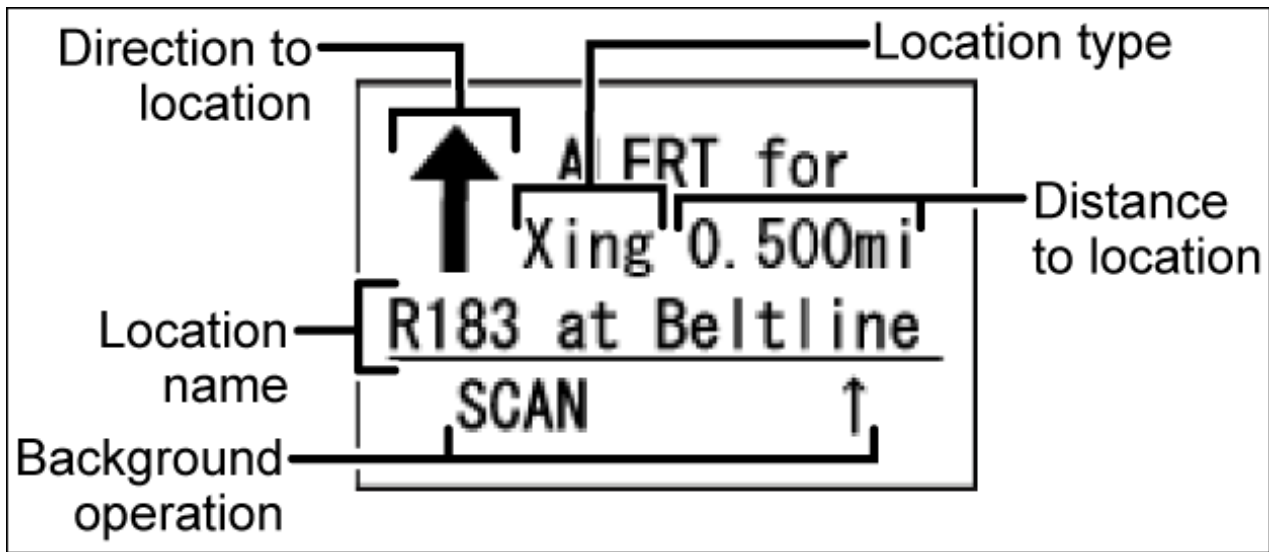



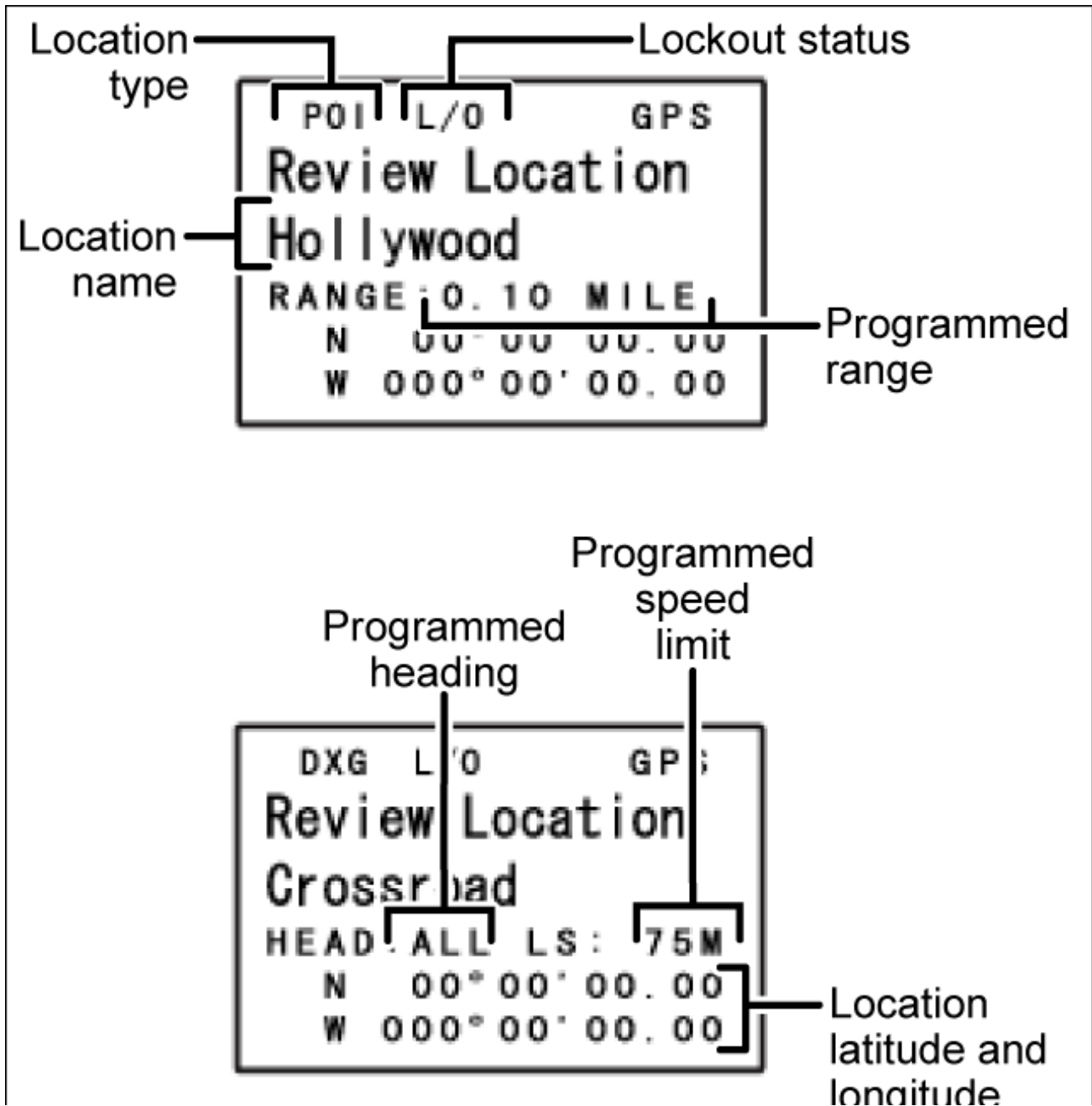

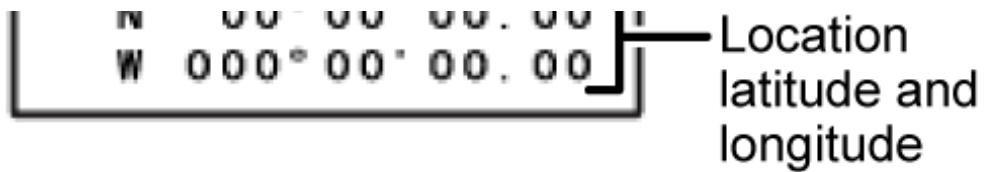

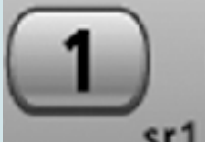
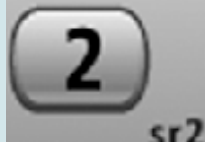

Location review display

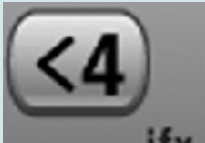
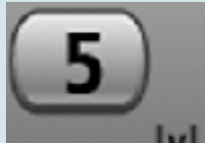

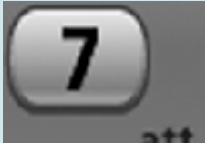
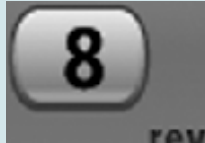

Key operation in GPS mode

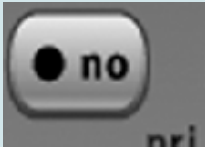
Key Name (2nd operation) Action on:	 Hold (Close call)	 1 (Search 1)	 2 (Search 2)	 3 (Search 3)
Tap	Toggle Hold mode on the scan or search running in the background. When reviewing locations: Enter Scan Hold mode.	NA	NA	NA
Key Name (2nd operation) Action on:	 Scan (Search)	 4 (IF exchange)	 5 (Volume offset)	 6 (Display mode)
Tap	Return to previous operation. When reviewing locations: Enter Scan mode.	NA	NA	NA
FUNCTION + Tap	NA	NA	NA	Cycle through the available displays.
Key Name (2nd operation) Action on:	 Lockout	 7 (Attenuation)	 8 (Reverse freq.)	 9 (Modulation)
Tap	Temporarily lockout the current Location Alert. When reviewing locations: Toggle the Lockout status of the current location.	NA	NA	NA
Double Tap	Permanently lockout the current Location Alert.	NA	NA	NA

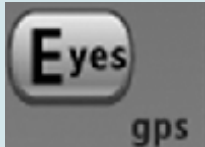
Press & hold	When reviewing locations: Unlock all locations of the current type (POI, Dangerous Road or Crossing).	NA	NA	NA
FUNCTION + Press & hold	When reviewing locations: Unlock all locations regardless of type.	NA	NA	NA
Key Name (2nd operation) Action on:	 Backlight (Power, Lock)	 No (Decimal, Priority)	 0 (Weather)	 Yes (Enter, GPS)
Tap	Turn on the LCD backlight.	During a system message: Cancel the message and exit that screen. When reviewing locations: Close the location review list.	NA	Open the location review location list. When reviewing locations: Edit the selected location.
Press & hold	Turn the scanner on or off.	NA	NA	NA
FUNCTION + Tap	Lock or unlock the keypad.	NA	NA	NA
FUNCTION + Press & hold	NA	NA	NA	When reviewing locations: Replace the select location's coordinates with the coordinates of your current position.

This page applies to the following scanner(s): [BCD396XT](#) [BC346XT](#) [Users Guide](#)

BC346XT Specs

- Certified in accordance with FCC Rules and Regulations Part 15 Subpart C as of date of manufacture. (See [FCC Information](#) for more details.)
- FCC ID: AMWUB358

- [General](#)
- [Frequency Range](#)
- [Special Functions](#)
 - [Band Scope Function](#)
 - [Two-Tone-Sequential](#)
 - [WX Alert](#)
- [Supported trunking systems](#)
- [Dynamic memory allocation capacity](#)
- [Heterodyne System](#)
- [CTCSS and DCS Tones](#)

General

Attenuation	20dB nominal
Audio Output Power	320mW nominal into 24Ω speaker
	20mW nominal into 32Ω stereo headphone
Scan Rate	100 channels per second max (Conventional mode)
Search Rate	300 steps per second max (5kHz steps only)
External Jacks	Antenna Jack: SMA Type
	Phone Jack: 3.5mm (1/8 in.) Stereo Type
	DC Power Jack: EIAJ TYPE-(Center Positive)

	GPS/Remote Interface Jack: 4pin Mini Type
Internal Speaker	24Ω, 0.8 W Max.(1.26 in.)
Power Requirements	3 x AA Size Rechargeable Ni-MH Batteries (1800mAh)
	3 x AA Size Alkaline Batteries
	AC Adapter (6V DC 800mA Regulated) (AD-1001)
Operating Temperature	Nominal: -20°C to +60°C -4°F to +140°F
	Close Call: -10°C to +60°C +14°F to +140°F
Size	2.40 in.(W) x 1.22 in.(D) x 5.35 in.(H) (Without Antenna)
Weight	0.37 lbs (Without Battery and Antenna)
Remote Functions	Direct PC control
	Database management
	Wired cloning
Display	64 x 128 Full Dot Matrix LCD with orange back light

Sensitivity (nominal) 12dB SINAD		
0.4•V	25–27.995 MHz	AM
0.3•V	28–53.98 MHz	NFM
0.5•V	54–71.95 MHz	WFM
0.2•V	72–75.995 MHz	FM

0.4•V	76–107.9 MHz	FMB
0.3•V	108–136.9916 MHz	AM
0.3•V	137–173.9875 MHz	NFM
0.5•V	174–215.95 MHz	WFM
0.3•V	216–224.98 MHz	NFM
0.3•V	400–512 MHz	NFM
0.4•V	806–960 MHz	NFM
0.5•V	1240–1300 MHz	NFM

Signal Noise Ratio (nominal)		
49dB	25–27.995 MHz	AM
43dB	28–53.98 MHz	NFM
55dB	54–71.95 MHz	WFM
48dB	72–75.995 MHz	FM
60dB	76–107.9 MHz	FMB
50dB	108–136.9916 MHz	AM
42dB	137–173.9875 MHz	NFM
55dB	174–215.95 MHz	WFM

40dB	216–224.98 MHz	NFM
39dB	400–512 MHz	NFM
42dB	806–960 MHz	NFM
38dB	1240–1300 MHz	NFM

Close Call Sensitivity (nominal):	
280•V	VHF Low1 Band
130•V	VHF Low2 Band
60•V	Air Band
60•V	VHF High1 Band
100•V	UHF Band
220•V	800MHz+ Band

Frequency Range

<u>Frequency Range</u> (MHz)	<u>Modulation</u>	<u>Step</u> (kHz)	<u>Name</u>
25.0000 - 26.9600	AM	5	Petroleum Products & Broadcast Pickup
26.9650 - 27.4050	AM	5	CB Class D Channel
27.4100 - 27.9950	AM	5	Business & Forest Products

28.0000 - 29.6800	NFM	20	10 Meter Amateur Band
29.7000 - 49.9900	NFM	10	VHF Low Band
50.0000 - 53.9800	NFM	20	6 Meter Amateur Band
54.0000 - 71.9500	WFM	50	VHF TV
72.0000 - 75.9950	FM	5	Intersystem & Astronomy
76.0000 - 87.9500	WFM	50	VHF TV
88.0000 - 107.9000	FMB	100	FM Broadcast
108.0000 - 136.9916	AM	8.33	Aircraft Band
137.0000 - 143.9875	NFM	12.5	Military Land Mobile
144.0000 - 147.9950	NFM	5	2 Meter Amateur Band
148.0000 - 150.7875	NFM	12.5	Military Land Mobile
150.8000 - 161.9950	NFM	5	VHF High Band
162.0000 - 173.9875	NFM	12.5	Federal Government
174.0000 - 215.9500	WFM	50	VHF TV
216.0000 - 224.9800	NFM	20	1.25 Meter Amateur Band
400.0000 - 405.9875	NFM	12.5	Miscellaneous
406.0000 - 419.9875	NFM	12.5	Federal Government Land Mobile
420.0000 - 449.9875	NFM	12.5	70 cm Amateur Band

450.0000 - 469.9875	NFM	12.5	UHF Standard Band
470.0000 - 512.0000	NFM	12.5	UHF TV
806.0000 - 823.9875	NFM	12.5	Public Service Band
849.0125 - 868.9875	NFM	12.5	Public Service Band
894.0125 - 960.0000	NFM	12.5	Public Service Band
1240.0000 - 1300.0000	NFM	25	25 cm Amateur Band

Special Functions

Band Scope Function

- Frequency Span 0.2 MHz To 500 MHz
- Frequency Step 5 kHz To 100 kHz

Two-Tone-Sequential

- 250-3500 Hz , 0.1 Hz Step Programmable

WX Alert

- 1050 Hz Tone System
- NWR-SAME System (Warning / Watch / Advisory)

Supported trunking systems

- Motorola Systems: Type I, II, II/I (hybrid)
- EDACS Systems: FM, NFM, and SCAT
- LTR Systems

Dynamic memory allocation capacity

- Systems: 500 max
- Groups: 20 per system

- Site: 1000 max (All) 256 per system
- Channels: 9000 max (20064 memory blocks)
- Channels per Trunked System: 500 max

Heterodyne System

- 1st IF: 380.7 to 380.8 MHz
- 2nd IF: 10.8 MHz
- 3rd IF: 450 kHz

CTCSS and DCS Tones

CTCSS Tone Frequencies (50 frequencies total)									
67.0	69.3	71.9	74.4	77.0	79.7	82.5	85.4	88.5	91.5
94.8	97.4	100.0	103.5	107.2	110.9	114.8	118.8	123.0	127.3
131.8	136.5	141.3	146.2	151.4	156.7	159.8	162.2	165.5	167.9
171.3	173.8	177.3	179.9	183.5	186.2	189.9	192.8	196.6	199.5
203.5	206.5	210.7	218.1	225.7	229.1	233.6	241.8	250.3	254.1

DCS Tone Codes (104 codes total)							
023	025	026	031	032	036	043	047
051	053	054	065	071	072	073	074
114	115	116	122	125	131	132	134
143	145	152	155	156	162	165	172
174	205	212	223	225	226	243	244

245	246	251	252	255	261	263	265
266	271	274	306	311	315	325	331
332	343	346	351	356	364	365	371
411	412	413	423	431	432	445	446
452	454	455	462	464	465	466	503
506	516	523	526	532	546	565	606
612	624	627	631	632	654	662	664
703	712	723	731	732	734	743	754

This page applies to the following scanner(s): [BC346XT Users Guide](#)

BC346XT

The Complete Reference

This document provides a complete reference to all menus, functions, and features of the BC346XT Handheld Trunk Tracker Scanner from Uniden. It is based on the Operation Specification that is used both as a guide to the software engineers for creating the scanner's user interface and as a repository for the "final say" on how every feature and function is implemented.

Some proprietary information has been removed, formatting has been modified, and extensive editing has been performed to make the text more readable. However, you will almost certainly find a handful of odd turns of phrases.

Mostly, though, we hope that this reference work can help you better understand and use your BC346XT. This document isn't intended to be a guide for how to use your scanner...you'll find that information in the Owner's Manual...but rather a reference for all the things that the scanner does. Combined with the Owner's Manual and the great resources available to scanner users online, you now have more information than ever on every facet of your scanner.

© 2009 Uniden Corporation
Fort Worth, TX
All Rights Reserved.

Contents

Feature Summary	8
Band Coverage	8
Channels	9
Memory Architecture	9
Channel Memory Scan	9
Priority Scan	9
Priority Plus Scan	9
Search with Scan	9
Scan Speed	9
Scanning Lockout	10
Temporary Lockout	10
Quick Keys	10
Startup Configuration	10
Channel Alert	10
Alpha Tagging	10
Duplicate Input Alert	10
Number Tag	10
Trunk Tracking	10
Multi-Site System	11
Control Channel Only	11
Priority ID Scanning	11
Preemptive Priority ID Scanning	11
Trunking Activity Indicators	11
Custom Search	11
Quick Search	11
Frequency Autostore	11
Search Speed / Turbo Search	11
Search Lockout	11
Search Key	12
Service Search	12
Broadcast Screen	12
Attenuator	12
Code Search	12
Volume Offset	12
IF Exchange	12
Dropout Delay	12

Weather and SAME Alert.....	12
Close Call [®] Frequency Capture	12
Close Call Temporary Store	13
Tone-Out Sequential Decode	13
Location-Based Scanning*	13
Location Alert System*.....	13
Navigation Modes*	13
GPS Compatibility*	13
Wired Cloning.....	13
Band Scope.....	13
PC Control.....	13
LCD and Keypad Backlight.....	13
Alert Tone Level.....	13
Battery Low Alert.....	14
Battery Save.....	14
Key Lock	14
Key Safe Mode.....	14
Repeater Reverse.....	14
Memory Backup	14
Design	15
Controls and Keys.....	16
Displays.....	21
LCD Design.....	21
Icons.....	21
Dot Matrix.....	22
LCD Flashing Time	22
Tones	23
General Tones	23
Weather Alert Sirens.....	23
Tones in Menu Mode	24
Selecting a menu item	24
Editing a name or a frequency etc.....	24
Alert in Scanner Mode	24
Alert in GPS Mode	24
Alert for Point Of Interest	24
Alert for Dangerous Xing.....	24
Alert for Dangerous Road	24

Battery Low Tone.....	24
Operation	25
Power On	25
Volume and Squelch Control	26
Volume Adjust Mode.....	26
Squelch Adjust Mode	26
Menu Mode	27
General Operations.....	27
Error Messages.....	30
Top Menu	31
Program System	31
Program Site	42
Program Group	51
Program Channel.....	55
Program Location.....	63
Srch/CloCall Opt	68
Search for.....	73
Close Call.....	82
Priority Scan.....	86
WX Operation.....	87
Tone-Out for	90
Wired Clone	94
Settings	95
SCAN MODE	101
Display during Scan Mode.....	101
Startup Key Operation	101
Start Scanning.....	101
Scanning Order	103
Scanning Operation	104
Temporary System Hold	115
System Hold.....	116
Quick System Select.....	116
Quick Save for CTCSS/DCS Data.....	117
Key Operation During Scan	118
SCAN HOLD MODE	120
Display while in Scan Hold Mode	120
General Operation.....	120

Hold on Conventional System	124
Hold on Trunked System	124
Hold on TalkGroup ID from ID Search / ID Scan.....	125
Direct Entry	125
Key Operation During Scan Hold Mode	128
PRIORITY SCAN.....	131
Priority Scan.....	131
Priority Plus Scan.....	132
Key Operation During Priority Scan.....	132
PRIORITY ID SCAN	133
Priority ID Scan	133
Key Operation During Priority ID Scan	133
SEARCH MODE	134
Display during Search Mode.....	134
General Operation.....	134
Service Search.....	135
Custom Search	136
Custom Search in Control Channel Only Mode.....	137
Search and Store	138
Quick Search.....	138
Key Operation During Search Mode.....	140
SEARCH HOLD MODE	142
General Operation.....	142
Go to Quick Search Hold Directly	142
Direct Entry	142
Quick Save	143
Key Operation During Search Hold Mode	144
CLOSE CALL MODE	146
Display during Close Call Mode.....	146
Close Call Search	146
Close Call Only	149
Close Call Hold	150
Close Call Auto Store.....	150
CC Hit with Scan.....	151
Direct Entry / Quick Save / Go to Quick Search Hold Mode	151
Key Operation During Close Call Only Mode	152
Key Operation During Close Call Hold Mode	153

WEATHER SCAN MODE	156
Normal Weather Scan.....	156
Weather Alert Scan.....	156
Weather (Alert) Scan Hold.....	157
Weather Alert Priority (WX Alt Priority)	158
Direct Entry / Quick Save.....	158
Key Operation During Weather (Alert) Scan Mode	158
Key Operation During Weather (Alert) Scan Hold Mode.....	159
TONE-OUT MODE	161
Display during Tone-Out Mode.....	161
Tone-Out Standby Mode.....	162
Tone-Out Search Mode	164
Tone-Out Hold Mode	165
Key Operation During Tone-Out Mode	166
GPS MODE.....	168
Display Mode in GPS Mode.....	168
Location Alert Operation	170
Registration of Location Information	173
Review Location Mode.....	174
Key Operation During GPS Mode.....	176
OBAND SCOPE MODE.....	178
Scope Mode	178
Search Mode.....	179
Max Hold Search Mode	179
Hold Mode.....	179
General Operation.....	180
Search Setting Parameters.....	181
Key Operation during Band Scope Mode	182
WIRED CLONE MODE	184
Confirm State	184
Transferring State	184
Complete State	184
Error State.....	185
Key Operation During Clone Mode.....	185
KEYLOCK	186
KEY SAFE MODE.....	187
Changed Key Operation in Key Safe Mode.....	187

Key Safe Operation.....	188
Key Safe Message	188
MEMORY INITIALIZATION	189
BATTERY CHARGE	190
Battery Type Select.....	190
Charging the Battery	190
OTHERS	193
AVAILABLE SYSTEM SETTINGS.....	193
System Settings	193
System Option Settings	193
Site Settings	194
Site Frequency Settings.....	194
Channel Settings.....	195
TGID FORMAT FOR TRUNKED SYSTEM.....	196
FLEET MAP	202
PRESET FLEET MAPS	203
WEATHER CHANNELS	204
CTCSS FREQUENCY	204
DCS CODE	204
CEA2009-SAME EVENT CODE(ANSI/CEA-2009-A October 2005).....	205
REMOTE COMMAND.....	207
CTCSS/DCS CODE LIST	254

Feature Summary

Band Coverage

Frequency (MHz)		Modulation	Step (kHz)	Remark
Lower Edge	Upper Edge			
25.0000	26.9600	AM	5.0	Petroleum Products & Broadcast Pickup
26.9650	27.4050	AM	5.0	CB Class D Channel
27.4100	27.9950	AM	5.0	Business & Forest Products
28.0000	29.6800	NFM	20.0	10 Meter Amateur Band
29.7000	49.9900	NFM	10.0	VHF Low Band
50.0000	53.9800	NFM	20.0	6 Meter Amateur Band
54.0000	71.9500	WFM	50.0	VHF TV Broadcast 2 – 4
72.0000	75.9950	FM	5.0	Intersystem & Astronomy
76.0000	87.9500	WFM	50.0	VHF TV Broadcast 5 – 6
88.0000	107.9000	FMB	100.0	FM Broadcast
108.0000	136.9916	AM	8.33	Aircraft Band
137.0000	143.9875	NFM	12.5	Military Land Mobile
144.0000	147.9950	NFM	5.0	2 Meter Amateur Band
148.0000	150.7875	NFM	12.5	Military Land Mobile
150.8000	161.9950	NFM	5.0	VHF High Band
162.0000	173.9875	NFM	12.5	Federal Government
174.0000	215.9500	WFM	50.0	TV Broadcast 7 – 13
216.0000	224.9800	NFM	20.0	1.25 Meter Amateur Band
400.0000	405.9875	NFM	12.5	Miscellaneous
406.0000	419.9875	NFM	12.5	Federal Government Land Mobile
420.0000	449.9875	NFM	12.5	70 cm Amateur Band
450.0000	469.9875	NFM	12.5	UHF Standard Band
470.0000	512.0000	NFM	12.5	UHF TV
806.0000	823.9875	NFM	12.5	Public Service Band
849.0125	868.9875	NFM	12.5	Public Service Band
894.0125	960.0000	NFM	12.5	Public Service Band
1240.0000	1300.0000	NFM	25.0	25 cm Amateur Band

Notes on Band Coverage:

- You can edit the Modulation and Step for each band. The above table shows the factory default values.
- Although TV bands are listed, the BC346XT cannot decode Digital TV audio.
- When you select “AUTO” for a channel or mode’s Modulation or Step, the above value is used (unless you’ve edited the Band Defaults).

Channels

Dynamic – You can create up to 9,000 total conventional channels, trunked channels, and trunked system frequencies.

- Channels in a conventional system contain a frequency.
- Channels in a trunked system contain a talk group ID (TGID).

Memory Architecture

Absolute Limits:

Systems	500
Sites Total	1,000
Sites/System	256
Channel Groups per System	20
Channels+System Frequencies	9,000
Channels per conventional system	1000
Channels per trunked system	500
Trunk Frequencies per Site	500-1000 (depending on total TGIDs stored in the system)

Notes about limits:

- The actual results will be limited by the first absolute limit you hit. For example, if you have created 1000 sites, you will not be able to create a new system even though you have created fewer than 500 systems.
- You can check the % of memory used by using the menu.

Channel Memory Scan

The scanner can scan any combination of trunked and conventional systems simultaneously.

Priority Scan

The scanner checks conventional priority channels every 1-10 seconds (2 seconds default) when scanning a conventional system.

Priority Plus Scan

The scanner scans only the conventional priority channels.

Search with Scan

The scanner can do Service and Custom Searches along with system scanning.

Scan Speed

100 Channels/Second (max) for conventional systems.

Scanning Lockout

You can lock out any System, Site, Channel Group, Channel, or search frequency.

Locked out channels are skipped (or ignored) during scanning.

If a system, site, or channel group is locked, all channels belonging to it will be skipped during scanning.

Temporary Lockout

Sites, Systems, Channels, or Frequencies temporarily locked out are automatically unlocked when power is cycled.

Quick Keys

You can assign an SQK (System/Site/Search Quick Key) from 0-99.

You can assign a GQK (channel Group Quick Key) from 0-9.

Quick keys can be rapidly enabled/disabled from the keypad during scanning.

Startup Configuration

You can assign a startup configuration key to a system or search range so that it can be automatically locked out or unlocked during power up.

Channel Alert

You can set a separate audible/visual alert for each channel.

Alpha Tagging

You can assign an alphanumeric name to each System, Site, Channel Group, Channel, Location, Custom search range, SAME group, and Tone-Out. You can use 16 characters per tag.

Duplicate Input Alert

The scanner will alert you if an entered alpha tag, frequency, etc has already been used in the same system.

Number Tag

You can assign a unique number tag from 0-999 to each system and to each channel within a system. This tag allows you to rapidly tune to a specific channel.

Trunk Tracking

The scanner can track the following types of trunked systems:

- Motorola Type I 800
- Motorola Type II 800, 900, UHF, VHF
- Motorola Rebanded
- EDACS Wide, Narrow, SCAT
- EDACS ESK (No ProVoice Decoding)
- LTR

Multi-Site System

All trunked systems can have more than one site. All sites in the system share the same Channel Groups and Channels.

Control Channel Only

Trunk Tracking can be achieved by entering only the control channels for Motorola systems.

Priority ID Scanning

Trunked channels can be assigned priority. When the scanner is monitoring the control channel, channels you tag as priority are given a higher priority over non-priority channels when they become active.

Preemptive Priority ID Scanning

For Motorola systems that have channel priority active on the system, if you flag a channel as priority and the system also has that TGID identified as a priority channel, the scanner will preempt any current transmission if the TGID becomes active.

Trunking Activity Indicators

The scanner shows all trunked activity when you hold on the control channel.

Custom Search

You can program up to 10 custom search ranges and either search them exclusively or include these searches when scanning.

Quick Search

If you hold on a conventional channel, you can start searching from the current frequency. If you hold on a trunked channel, you can quickly switch to ID Search mode.

Frequency Autostore

The scanner can automatically store frequencies found during a search.

Search Speed / Turbo Search

- 100 Steps/Second in search mode (max, except for 5 kHz steps)
- 300 Steps/Second in search mode (max, 5 kHz steps)
- Turbo mode automatically applies to 5 kHz step searches.

Search Lockout

You can lock out up to 500 frequencies.

- The limit of temporary L/O frequencies: 250
- The limit of permanent L/O frequencies: 250
- Locked out frequencies will be skipped in Search Mode or Close Call Mode.
- You can review all locked out frequencies in Menu Mode.

Search Key

Search keys are short cuts to start searching for a single search range.

There are 3 search keys (sr1 to sr3).

Service Search

You can search preset frequencies typically used by specific agencies or groups.

The kind of Service Search is as follows: Public Safety, News, HAM Radio, Marine, Railroad, Air, CB Radio, FRS/GMRS/MURS, Racing, FM Broadcast, Special

Broadcast Screen

Allows the scanner to ignore hits on Pager, FM, UHF TV, VHF TV, NOAA WX and custom band frequencies.

Attenuator

You can attenuate the incoming signal for channels that get interference from strong signal sources.

You can set a global attenuator to apply attenuation to all reception.

Code Search

Rapid search for the CTCSS/DCS used during a transmission.

Volume Offset

Adjust the volume level for any channel from -3 to +3 steps to balance audio level.

IF Exchange

Switches the current frequency to use a different IF (intermediate frequency) for receiving radio signals to avoid interference.

Dropout Delay

Controls whether the scanner pauses at the end of a transmission to wait for a reply.

You can set the Delay time for each System. All Channels in the System share the same delay setting. You can also set the Delay time for Search, Close Call and Tone-Out.

You can set the minus delay time. In that case, the scanner only stops on transmissions for the set duration, then automatically resumes.

Weather and SAME Alert

The scanner can alert to Weather Alert Tone, all FIPS or selected FIPS.

Close Call[®] Frequency Capture

The scanner can immediately detect and lock onto a transmission above threshold signal strength.

Close Call Temporary Store

The scanner scans the last 10 frequencies captured by Close Call so that you can continue to receive the signal even after the signal is not strong enough to trigger a Close Call hit..

Tone-Out Sequential Decode

Lets you set the scanner to act as a two-tone pager for fire tone-out standby. If you do not know the tones being used, the scanner can detect the tones when it receives a page.

Location-Based Scanning*

The scanner can automatically lock and unlock systems, sites and channel groups based on your current location as provided by an external GPS unit (not included).

Location Alert System*

The scanner alerts you when you approached a stored location.

Navigation Modes*

Indicate the Direction / Distance / Time to Goal for locations you set.

GPS Compatibility*

Compatible GPS units output location data that conforms to NMEA-0183 v3.01. The scanner uses the GGA and RMC sentences as defined by that specification. Note that this standard specifies an RS232 serial connection. GPS units that have USB connectivity are not compatible with this scanner.

Wired Cloning

You can clone all programmed data, including Memory Architecture, Menu settings and other parameters from one BC346XT to another BC346XT connected with RS232C cable.

Band Scope

Band Scope Mode searches a frequency range and displays a graphic of the signal level in real time.

In Band Scope Hold Mode, the user can monitor the frequency displayed.

PC Control

You can download information into the scanner and control the scanner via your personal computer.

LCD and Keypad Backlight

The Display Keypad backlight is orange.

The backlight can be adjusted to 3 different brightness levels

Alert Tone Level

This feature lets you adjust the volume level of the following tones: Key Beep, Emergency Alert, Channel Alert, Close Call Alert, Tone-Out detection Alert, Battery Low Alert and Location Alert.

Battery Low Alert

When the battery voltage becomes low, the  icon will blink and a Battery Low Tone will be generated every 15 seconds. This alert level is set at the same level as the key beep volume level.

Battery Save

You can turn on/off this function by Menu Operation.

This works when there is no transmission over 1 minute in the following modes. This feature turns off RF power for 1 second and turns on it 300 ms to extend the battery life.

- Scan Hold Mode at a Channel of conventional System (without Priority Scan)
- Any Search Hold Mode

Key Lock

This feature disables the keypad and scroll to prevent any accidental input.

Key Safe Mode

This mode helps keep novice users from accidentally changing parameters or modes.

Some keys don't work in this mode.

Repeater Reverse

One-touch key lets you switch to hearing the input frequency on a conventional repeater system or trunked system.

Memory Backup

Scanner memory is backed up semi permanently.

Design

The below is a design reference. There might be some differences between this image and the actual final design.



Controls and Keys

“Long press” means pressing a key more than 2 second.

Each key has a “normal” mode and a “Function” mode.

Normal Mode:

Normal Mode means that the scanner is not in Function Mode. In this mode, the **F** icon is not displayed.

Function Mode:

- Pressing [FUNC] puts the scanner into Function Mode for 3 seconds. While it is in Function Mode, the scanner displays the **F** icon. If you press a button, the Function Mode time is continued for another 3 seconds.
- Long pressing [FUNC] puts the scanner into Function Mode without a timeout. The scanner displays “Function Key” and “Holding”, and the **F** icon blinks.
- Pressing [FUNC] again in each Function Mode returns to Normal Mode and the **F** icon disappears.

Scroll Control

- Selects a channel or frequency in Hold Mode.
- Selects Menu items in Menu Mode.
- Selects a character while editing the Name.
- Sets the level in Volume / Squelch Level Control mode.

Scroll Control Push

- Pressing this works the same operation as pressing [E / yes / gps] in Menu Mode.
- Press this to set the volume level in the mode that is not Menu Mode.

Function + Scroll Control

- Use to select a System in Scan or Scan Hold Mode.

Function + Scroll Control Push

- Press this to set the squelch level in any mode other than Menu Mode.

Scan / srch (Search) Key

- Press to resume scanning. (Scan Hold Mode and while monitoring a channel in Scan Mode)
- Press to go to Scan Mode. (Except Scan Mode, Scan Hold Mode and GPS Mode)
- Press to return to the scanner screen. (GPS Mode)

Function + Scan / srch Key

- Press to resume searching. (Search Hold Mode and while monitoring in Search Mode)
- Press to toggle between ID SCAN and ID SEARCH while scanning a trunked system.
- Press to display the Quick Search Prompt. (Except in Search Mode, Search Hold Mode, GPS Mode and Band Scope Mode)
- Press to return to the scanner screen. (GPS Mode)
- Press to change the band scope search type. (Band Scope Mode)

Hold / (Close Call) Key

- Press to go to each Hold Mode. (Scan Mode, Search Mode, Close Call Only Mode, WX Scan Mode and Band Scope Mode)
- In Close Call Only Mode, the scanner sounds an Error Tone if it has not yet gotten a hit.
- Press to resume scanning or searching. (Hold Mode)
- Long press to go to the System Hold Mode (Scan Mode, Scan Hold Mode)

Function + Hold / Key

- Toggles the setting of Close Call.
- Long press to start Close Call Only Mode.

L/O (Lockout) Key

- Press once to temporarily lock out a system channel, a search frequency or a location data. This lock out is canceled when the power is turned off then back on.
- Press twice within one second to permanently lock out a system channel, a search frequency or a location data. This lockout remains even if the power is turned off.
- Long press to unlock all settings of the current system. (Scan Mode and Scan Hold Mode)
- All Locations of the current Type are unlocked by long-pressing this key. (Review Location Mode)
- The scanner unlocks all frequencies of Global Lockout List*. (Search Mode, Search Hold Mode, Close Call Only Mode and Close Call Hold Mode)
- Press to cancel a prompt without changing settings in Menu Mode.

*Global Lockout List means collecting the locked out frequencies at Search Mode, Search Hold Mode, Close Call Only Mode and Close Call Hold Mode.

Function + L/O Key

- Press once to temporarily lock out the current system, current site or current search range in Scan Mode and Scan Hold Mode. This lock out is cleared when power is turned off then back on.
- Press twice in a second to permanently lock out the current system or current search range in Scan Mode and Scan Hold Mode. This locked out is kept even if the power is turned off.
- Press to go to Rvw Search L/O. (Search Mode, Search Hold Mode, Close Call Only Mode and Close Call Hold Mode)
- Long press to display the prompt to unlock all systems, sites, search ranges and Close Call Hits system and enable all Quick Keys for systems/sites/search ranges. (Scan Mode and Scan Hold Mode) If you press [E / yes / gps], the scanner unlocks all data. If you press [. / no / pri], the scanner returns to the previous mode without unlocking.
- Long press to display the prompt for unlocking all Locations of all types. (Review Location Mode of GPS Mode) If you press [E / yes / gps], the scanner unlocks all data. If you press [. / no / pri], the scanner returns to the previous mode without unlocking.

(Light) / (Power) / (Key Lock)

- Press to illuminate the LCD back light according to Menu setting or to turn the backlight off if it is on.
- Press and hold to turn the scanner on or off.

Function + / / Key

- Press to lock or unlock the keypad.

1 - 9, 0 Key

- Press to enable or disable the System/Site/Search Quick Key for system or search range. (Scan Mode)
- Press to turn on or off each custom search range number. These keys operate only in Custom Search and not in other searches. (Search Mode)
- Press to go to Direct Entry Mode or to enter a Number Tag. (All Hold Mode, Close Call Mode and Tone-Out Mode)
- While editing a name, press [4 / LEFT] or [6 / RIGHT] to move the cursor to the left or right.

Function + 1 - 9, 0 Key

- Press to enable or disable Groups Quick Key in Scan Mode.

Function + 1 - 3 / sr1 - 3 (Search) Key

- Press [1 - 3 / sr1 - 3] to start Service Search, Custom Search, Tone-Out Mode or Band Scope Mode in Set Search Key. (except Scan Mode and GPS Mode)

Function + 4 / LEFT / ifx (IF Exchange) Key

- Press to exchange the IF (intermediate frequency) for receiving radio signals to avoid interference. (except Scan Mode and GPS Mode)

Function + 5 / |v| (Volume Offset) Key

- Press to change the volume offset level. (Scan Hold Mode)

Function + 6 / RIGHT / disp Key

- Press to change the Display Mode. (Scan Hold Mode and Custom Search Mode)
(Display mode 1 -> Display mode 2 -> Display mode 3 -> Display mode 1 ->....)
- Press to change the GPS Display. (GPS Mode)

Function + 7 / att (Attenuator) Key

- Press to toggle the attenuation state. (except GPS Mode)
- Long press to toggle global attenuator. (except GPS Mode)

Function + 8 / rev (Reverse) Key

- Press to monitor the current frequency's reverse frequency. It returns to current frequency when the key is released. (Scan Hold Mode, Search Mode, Search Hold Mode, Close Call Only Mode and Close Call Hold Mode)

Function + 9 / mod (Modulation) Key

- Press to change the modulation state. (except GPS Mode and WX Scan Mode)

Function + 0 / wx (Weather) Key

- Press to toggle WX Scan Mode and WX Alert Scan Mode while WX Scan or WX Alert Scan.
- Press to toggle WX Alert Priority. (except WX Scan Mode)
- Long press to start WX Scan. (except WX Scan Mode)

. (Decimal) / no / pri (Priority) Key

- Press to cancel these displays while displaying Error or Warning message.
- Press to input "."(decimal) for frequency.
- Press to input "-" or "i" for TGID.
- Press to input a space in editing a data name.
- Press twice to clear the data in editing data name.
- Press to input "-" or "i" for Direct Enter in Hold Mode, Close Call Only Mode, Tone-Out Mode.
- Press in Scan Mode to start the selection for the ten's place of a System/Site/Search Quick Key. Then, press number key to jump to each number's place of a Quick Key.

Function + . / no / pri Key

- Press to toggle Priority Mode in Scan Mode. (On / Plus On / Off)

E (Enter) / yes / gps Key

- Press to accept the input data or a Menu Item.
- Press to edit the channel data. (Scan Mode and Scan Hold Mode)
- Press to quickly save the frequency in Search Mode, Search Hold Mode, Close Call Mode, Close Call Hold Mode, WX Scan Mode and WX Scan Hold Mode.
- Press to go to the editing menu for current Tone-Out.
- Press to go to Review Location Mode. (GPS Mode)

Function + E / yes / gps Key

- Press to change GPS Mode.
- Long press to store a current location data.

Menu Key

- Press to enter the Menu Mode.
- Press to go back up one menu level when in the Menu Mode.
- Press after entering the value to indicate going to a number tagged system or channel.

Function + Menu Key

- Press to go to the editing menu for the current system, search range or location data.

Displays







LCD Design

The reference design shown below is for illustration purposes only and is not intended to be a photorealistic representation of the display.



Icons

- Sx: : This icon appears with icons of System and Site Quick Key numbers (from "0" to "99"). "x" shows the current ten's place of Quick Keys for Systems or Sites.
- GRP: This icon appears with icons of Quick Key number for Channel Groups (1 - 9, 0).
- 1 - 9, 0: In SCAN mode, the numbers of unlocked Quick Key for Systems/Channel Group are displayed. The number for the currently scanned SQK set flashes.
- In SCAN HOLD mode, the Quick Key number for the current System/Channel Group appears.
- Enabled User Range numbers appear in Custom Search; the current range's number blinks.
- HOLD: This icon appears in Scan Hold, Search Hold and Close Call Hold Mode.
- L/O: This icon appears at a locked out Channel or frequency.
- PRI: This icon turns on during Priority Scan and this blinks during Priority Plus.
- GPS: This icon appears when the scanner receives GPS data. This shows in the same place as " ".
- AM / FM / NFM / FMB / WFM: These icons show the modulation type.
- ATT: This icon appears when a channel has attenuator on and blinks when global attenuator is on.
- 067.0 / DCS023 etc.: The scanner displays the CTCSS/DCS here.

- SCR: This icon appears when one or more Broadcast Screen Band is set to on.
- WX: This icon turns on while the Weather Alert Priority Scan works.
-  (Function icon) : This icon appears in Function Mode. Function Mode does not have a timeout when this icon blinks.
-  (Priority Channel) : This icon appears when the channel set to "Priority On".
-  (Signal Indicator) : This icon shows strength of the signal from 0 to 5.
-  (KEYPAD LOCK): This icon will appear only when the KEYLOCK function is On.
-  (BATTERY Low Alert): This icon blinks when the battery voltage is low. This icon blinks when a bad battery is installed and an AC adapter is connected. This icon appears during battery check.
-  (Close Call Pri) : This icon appears in Close Call Priority Mode. This blinks in Close Call Only Mode or when the scanner gets a Close Call hit.
-  (Close Call DND) : This icon appears in Close Call DND Mode is CC DND Mode. This is a reverse display of Close Call Pri icon.

Dot Matrix

The display element consists of a 128 x 64 pixel display. See Font Data for character patterns.

Since the display is entirely dot matrix, a great variety of different things can be shown. The above shows the most common display elements in most modes. Additional examples are shown throughout this reference guide.

LCD Flashing Time

About 500 mS on/500 mS off (1 Hz).

Tones

The scanner can produce 3 fundamental tones, high (1200 Hz), middle (920 Hz), and low (640 Hz). Furthermore, there are Alert Tones and Weather Alert Sirens which include other sounds.

Additionally, special alert tones (Location Alert, CC alert, Emergency alert and WX alert, etc) can be set to custom volume levels.

General Tones

Key Touch Tone

When you press valid keys, the scanner will sound single high beep for 50 ms.

Confirmation Tone

The scanner will sound double high beep for confirmation (50 ms beep - 100 ms silent - 50 ms beep).

Exec Tone

When you press [E / yes / gps] key etc. to accept the entry or setting, the scanner will sound high-middle beep (75 ms high beep - 25 ms silent - 75 ms middle beep).

Error Tone

When you press a key that does not have a valid function in the current mode, the scanner will sound a triple low beep (75 ms beep - 25 ms silent -- repeat 2 times)

Weather Alert Sirens

The scanner sounds the following tones until any key is pressed, or for 8 seconds.

For Warning

[100 ms 120 Hz - (20 ms every 150 - 195 Hz in 5 Hz step) - (30 ms every 200 - 590 Hz in 10 Hz step) - 500 ms 600 Hz - 100 ms silent] --- repeat

For Watch

[(50 ms 800 Hz - 30 ms silent - 50 ms 1050 Hz - 30 ms silent) -- repeat 3 times - 170 ms silent] --- repeat

For Advisory

[100 ms 800 Hz - 50 ms silent - 100 ms 1050 Hz - 500 ms silent] -- repeat

For Weather Alert Tone: Same as Weather Alert Siren For Warning.

Tones in Menu Mode

Selecting a menu item

As you step to the next menu item by turning [Scroll Control] knob, the scanner will sound a single high beep for 100 ms.

However, if the menu item is the last item and you turn [Scroll Control] knob in the clockwise direction, the scanner will sound a double high beep (75 ms beep - 25 ms silent - 75 ms beep).

When you select a menu item by pressing [E / yes / gps] key, the scanner will sound a single middle beep for 100 ms.

Or, when you return to a previous menu by pressing [MENU] key, the scanner will sound a double middle beep (75 ms beep - 25 ms silent - 75 ms beep).

Editing a name or a frequency etc

When you select letters, the scanner sounds a single high beep for every click of the [Scroll Control] knob.

When you move the cursor from the left to the right, the scanner will sound a single middle beep (100 ms).

Or, when you move the cursor from the right to the left, the scanner will sound a double middle beep (75 ms beep - 25 ms silent - 75 ms beep).

If you store data by pressing [E / yes / gps], the scanner sounds the Exec Tone.

Alert in Scanner Mode

You can select channel or frequency alert from Alert1-9 in Menu by "Set Alert" and "Emergency Alert".

Each alert has a unique pattern of tones.

Alert in GPS Mode

Alert for Point Of Interest

You can select a location alert from Alert 1 to Alert 4 in Menu. Each alert provides a unique pattern of tones.

Alert for Dangerous Xing

The alert for Dangerous Xing is a fixed three-tone sequence.

Alert for Dangerous Road

The alert for Dangerous Road is a fixed five-tone sequence.

Battery Low Tone

At the low battery voltage level, the scanner will sound a single low beep (100 ms) every 15 seconds.

Operation

NOTE: Valid keys for the "Press Any Key" prompt are all keys except for [🔦 / 🔌 / 🔑]. Pressing [🔦 / 🔌 / 🔑] always turns on or off the backlight. And specially, pressing [L/O] cancels the prompt and exit from any Menu and so on immediately.

Power On

Press [🔦 / 🔌 / 🔑] for 1 second to turn on the scanner.

The scanner displays the opening screen and the copyright notice, and finally goes to the LAST MODE. The last select GPS Display mode is also backed up.

Notes on the Last Mode:

- LAST MODE means the mode when the scanner is turned off. It resumes Scan Mode, Custom/Service/Quick Search Mode, Weather Mode, Close Call Only, Tone-Out Mode, each Hold Mode, GPS Mode and Band Scope Mode for LAST MODE.
- In ID Search Hold Mode if ID has already been registered, LAST MODE will be ID Search Hold Mode. If ID has not been registered yet, LAST MODE will be Scan Mode.
- Review Location Mode is set to normal Scanner Mode (not GPS Mode).

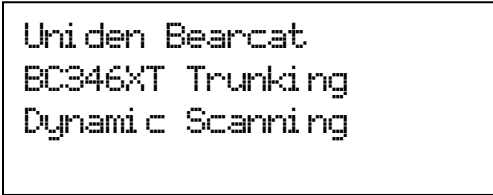

```
Uniden Bearcat  
BC346XT Trunking  
Dynamic Scanning
```

Opening Screen

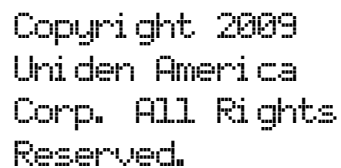

```
Copyright 2009  
Uniden America  
Corp. ALL Rights  
Reserved.
```

Copyright Notice Screen

Volume and Squelch Control

Volume and Squelch can be adjusted by rotating the [Scroll Control] in the following modes: Scan Mode, Scan Hold Mode, Search Mode, Search Hold Mode, Tone-Out Mode, Weather Scan Mode, Close Call Only Mode, Band Scope Mode, Band Scope Hold Mode.

Volume Adjust Mode

To adjust the volume level, press [Scroll Control]. When the volume level indicator appears, rotate [Scroll Control] to change the volume level.

You can set the volume level from 0 to 15.

Press [Scroll Control] again or wait for 10 seconds to quit from the volume level control mode.

Squelch Adjust Mode

To adjust the squelch level, press [Function] + [Scroll Control]. When the squelch level indicator appears, rotate [Scroll Control] to change the squelch level.

The squelch level can set from 0 to 15.

Press [Scroll Control] key again or wait for 10 seconds to quit from the squelch level control mode.

Menu Mode

General Operations

Key Operation

To enter the Menu Mode: Press [Menu]

To select a Menu item: Turn [Scroll Control]

To select a Menu item or input data: Press [E / yes / gps] or tap the [Scroll Control]

To Return to the previous: Press [Menu]

To exit from Menu Mode:

- ➔ Press [Scan / srch] to go to Scan Mode
- ➔ Press [Hold / - ➔ Press [Menu] at Top Menu to return to previous mode
- ➔ Press [L/O] to exit Menu and return to previous mode

Notes:

- Tapping the [Scroll Control] can be used instead of [E / yes / gps] in Menu Mode or at various prompts.
- Next item is a lower item in this document. Therefore, the next item of the lowest Item is highest item.
- Menu items are described as the bold letter in this specification.

Display Format in Menu Mode

The Menu Item screen is four-line mode.

The first line displays the Menu Item Name and the selection items are displayed below.

For example, the Menu display of a channel modulation setting is as follows.



Select an item by turning [Scroll Control] until the item is highlighted, then pressing [E / yes / gps].

Edit Name

The editing cursor is displayed. Turn [Scroll Control] to choose the character and the cursor stays at the highlighted position.

Press [4 / LEFT / ifx] to move the cursor to the left and [6 / RIGHT / disp] to move it to the right.

Press [. / no / pri] once to erase one character with the cursor. Press it twice to erase all characters.

If the inputted name exists already in the same category, the scanner beeps Confirmation Tone and displays "Name Exists" and "Accept? (Y/N)".

By "Same category" we mean:

- A system name is the same as a service search range name, custom search range name or other system name.
- A group name is the same as another group name in the same system.
- A channel name is the same as another channel name in the same group.
- A custom search range name is the same as a system name, service search range name or other custom search range name.
- A SAME name is the same as another SAME name.
- A Tone-Out name is the same as another Tone-Out name.

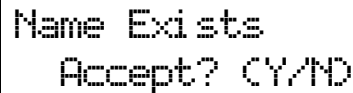

```
Name Exists
Accept? CY/ND
```

Press [E / yes / gps] to ignore the message and set the name. Then it proceeds to next step.

Press [. / no / pri] to return to the name editing state.

Note: If the user name has no character, the scanner prompts "Set Default Name" and "OK? (Y/N)".



```
Set Default Name
OK? CY/ND
```

Press [E / yes / gps] to set Name to the default name. Press [. / no / pri] to return to name editing.

Edit Frequency and Set Tone

The editing cursor is displayed.

Press a number key to enter each digit and press the decimal key to input a decimal point.

The cursor moves to the left or the right by turning [Scroll Control] knob.

If you press the decimal key when a decimal point is already entered, the frequency data is cleared and the editing cursor moves to the first position.

The stored frequency is determined by the following:

- The entered frequency is stored if it can be divided by a valid step.
- If it cannot be divided by a valid step, the scanner stores the nearer frequency at a frequency of 5kHz step or a frequency of 6.25kHz step. So, you must input the correct frequency to store a frequency of 7.5 kHz step or 8.33 kHz step. (See: Band Coverage)

If the frequency is out of the range in Band Coverage, the scanner displays "Out of Band", "Press Any Key" and sounds an Error Tone. Press any key to return to editing mode.

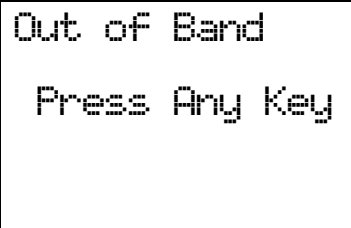

Out of Band
Press Any Key

For Channel Frequencies in conventional System, if the entered frequency is already stored into the same Group, it displays "Frequency Exists" "Accept? (Y/N)" and sounds a Confirmation Tone. Press [E / yes / gps] to ignore message and proceed to next step. Or press [. / no / pri] to return to the editing mode.

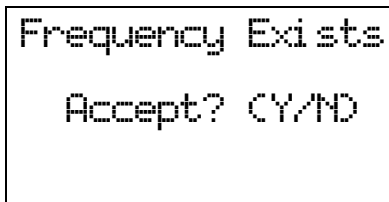

Frequency Exists
Accept? (Y/N)

Edit Talk Group ID

Decimal TGID edit

The editing cursor is displayed.

Press a number key to enter the TGID and press the decimal key to enter a hyphen. The cursor moves to the right by entering a number or hyphen.

Press the decimal key first to set "i" for I-Call entries. Then press the number keys to enter the I-Call ID.

Turn the [Scroll Control] to move the cursor position from left end to next to right end character, or from left end to right end character when you have already entered the maximum length.

Hexadecimal TGID edit

Turn the [Scroll Control] to select Hexadecimal characters from “0” to “F”,

Press [4 / LEFT / ifx] to move the cursor left or press [6 / RIGHT / disp] to move cursor right.

Press [E / yes / gps] to set the Hex ID.

Note: You can change the TGID format in *Set ID Format (DEC/HEX)*

If you press the decimal key when there are already an acceptable number of hyphens, the TGID is cleared and the editing cursor moves to the first position.

Note: For details of TGID formats, please see: *TGID FORMAT FOR TRUNKED SYSTEM.*

If the entered TGID is invalid, the scanner beeps an Error Tone and displays "Bad TGID".

Press any key to return to the editing mode.

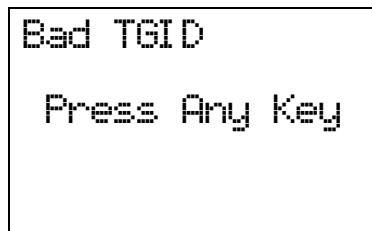

Notice of Location Data Input

Use WGS84 (World Geodetic System 1984) for latitude and longitude input.

The acceptable range of latitude and longitude is as follows.

- Latitude : 90°00'00.00 S - 00°00'00.00 N - 90°00'00.00 N
- Longitude : 180°00'00.00 E - 000°00'00.00 W - 180°00'00.00 W

The actual navigation distance may differ from the calculated one when a latitude exceeding 85 degrees (either North or South) is used.

Error Messages

If the scanner tries to create a new System/Location/Site/Group/Channel/TGID when it is already at the limit of System/Group/Channel, it displays “Over Limit”. (See: Memory Architecture)

If the scanner tries to create a new System/Location/Site/Group/Channel/TGID when the memory is full, it displays “Memory Full”.

If the scanner tries to create a new System/Location/Site/Group/Channel/TGID when the memory is broken, it displays “Memory Error”. When the scanner displays this message, you must initialize the memory by pressing [2 / sr2] + [9 / mod] + [Hold / 

Top Menu

Press [MENU] key to go to Menu Mode. Top Menu has the following items.

- Program System
- Program Location
- Srch/CloCall Opt
- Search for...
- Close Call
- Priority Scan
- WX Operation
- Tone-Out for ...
- Wired Clone
- Settings

Turn the [Scroll Control] to select items and press [E / yes / gps] to go to the selected item.

Press [Menu] to exit from Menu Mode.

Program System

You can select a System for editing or create a new System.

Names of existing Systems are displayed as Menu Items. These systems are sorted by the order in which they were created. "New System" is displayed as the last menu item.

Note: When no systems have been programmed, only "New System" appears.

The limit of Systems is 500. So, if you try to select "New System" when there are already 500 Systems, the scanner displays "Over Limit" and sounds an Error Tone. Then it returns to Top Menu.

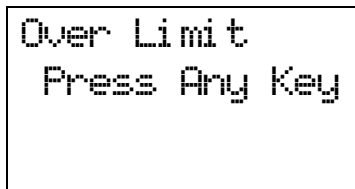

```
Over Limit
Press Any Key
```

Select the System Name and press [E / yes / gps] to go to the Systems Settings Menu. (See: System Settings)

If you select a protected system, "Protected System Access Not Allowed Press Any Key" is displayed and an Error Tone sounds.

Select "New System" and press [E / yes / gps] to create a new System.

Creating a New System

You can create up to 500 systems.

To create a new system, select the system type from the following items.

MOT Select for any Motorola Type system
EDCS Select for EDACS WIDE/NARROW or EDACS SCAT system
LT Select for an LTR system
Conventional Select for a non-trunked system.

If you select an EDACS type, you need to select more system type information from the following:

WIDE/NARROW Select for an EDACS WIDE/NARROW system
SCAT Select for an EDACS SCAT system

Once you select the system type, the scanner prompts "Confirm?" and "Yes="E" / No=".". "".

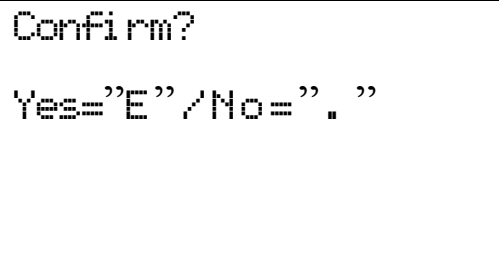

```
Confirm?  
Yes="E" / No="." . "
```

Press [E / yes / gps] to confirm, and the system will be created.

Press [. / no / pri] to reject and return to the Menu of Select System.

When the System is created, the scanner assigns a default System name of "System xxx T" to the new System. (xxx: 1-3 digits sequential number / T: initial of type; MOT="M", EDACS="E", LTR="L", Conventional="C"). Then, the scanner goes go to Edit System Menu.

Note: Once a system has been created, the system type setting cannot be changed.

System Settings

This menu has the following items.

- Edit Name
- Edit Sys Option
- Edit Site
- Edit Group
- Copy System
- Delete System

These setting items are different for each System Type. See [System Settings](#) for details of the differences.

The first line displays the System name. For example, the following figure shows it is in settings of the System named "System 1 C".

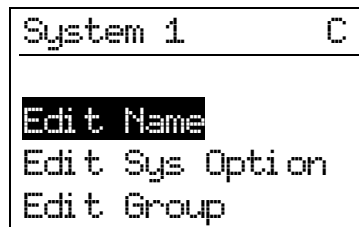

Turn the [Scroll Control] and press [E / yes / gps] or tap the [Scroll Control] to go to each setting.

Edit Name

You can name the system. Refer to [FONT DATA](#) for the characters that can be entered.

Press [E / yes / gps] to accept the name entered. The scanner returns to the previous menu.

Edit Sys Option

You can change the following System settings.

- Set Quick Key
- Set Startup Key
- Set Number Tag
- Set Lockout
- Set Hold Time
- ID Scan/Search
- Set Delay Time
- Edit Fleet Map
- Priority ID Scan
- Set Status Bit
- Set End Code
- Emergency Alert
- Set ID Format (DEC/HEX)
- Set ID Format (AFS/DEC)
- Rvw ID:Srch L/O
- Clr All L/O IDs

These setting items are different for each System Type. See *System Option* for details of the difference.

Press [E / yes / gps] to enter each setting.

Set Quick Key

This option allows you to select key that will rapidly lock/unlock the System when the scanner is Scan Mode. Turn the [Scroll Control] to select the Quick Key for the System. The Quick Key can be set from "0" to "99" and "." (= Not assigned).

Press a number key to jump the cursor to the head number of ten's place. For example if you press [2 / sr2], the cursor jumps to "20".

Press [E / yes / gps] to accept and return to the previous menu.

Note: The highest number of priority is Quick Key 1 and lowest number is Quick Key 90.

(See: *Scanning Order.*)

Set Startup Key

The scanner locks or unlocks the system according to setting of this option by pressing and holding a number key at power-on or while displaying the Opening Screen.

Turn [Scroll Control] to select the Startup Key in this menu. The Startup Key can be set from "0" to "9" and "." (= Not assigned).

Press [E / yes / gps] to accept the selection and return to the previous menu.

Set Number Tag

The System Number Tag can be set in this menu.

Press a number key to input the number tag. Press [./no/pri] to clear the input.

Press [E/yes/gps] to accept the setting and return to the previous menu.

Note: The valid setting range is from 0 to 999. Blank means a number tag not assigned.

Set Lockout

This option allows you to lock or unlock the current system. When the system is locked out, the scanner does not check it.

Unlocked	The system is unlocked.
Temporary L/O	The system is temporarily locked out.
Lockout	The system is locked out.

Press [E/yes/gps] to accept the selection and return to the previous menu.

Set Hold Time

This setting determines the minimum time the scanner is forced to hold and scan System Channels before moving to the next System, even if there is no traffic on the Channels. You can set it from 0 to 255 seconds by pressing a number key.

Press [E/yes/gps] to accept the entry and return to the previous menu.

If you enter over "255" for the Hold Time, the scanner prompts "Out of Range" and "Set Max? (Y/N)". When [E/yes/gps] is pushed, maximum value 255 will be set.

It returns to the edit state, if you press [./no/pri].

Note: The scanner will check all unlocked Channels at least 1 time before moving to the next system, independent of whether the hold time has been set or not.

ID Scan/Search

This setting determines how the scanner scans trunked Systems.

ID Scan	The scanner only stops on TGIDs that have been programmed and not locked out.
ID Search	The scanner stops on any TGID that is not locked out.

Press [E/yes/gps] to set the setting and return to the previous menu.

Set Delay Time

This setting controls how long the scanner stays on a transmission before resuming scanning. If you select a positive value, the scanner will hold on the channel for that duration after the carrier drops before resuming scanning. If you select a negative value, the scanner will stay on a transmission until the carrier drops or until the selected time elapses, whichever is shortest.

Turn [Scroll Control] to select the delay time setting from the following list:

- 10 sec
- 5 sec
- 2 sec
- 0 sec
- 1 sec
- 2 sec
- 5 sec
- 10 sec
- 30 sec

Then press [E / yes / gps] to accept and return to the previous menu.

Edit Fleet Map

Motorola 800 Type I/Hybrid Systems require a Fleet Map that sets specific Fleet - SubFleet parameters. There are 16 preset Fleet Maps listed in [PRESET FLEET MAP](#) that you can choose, and these are usually a good place to start when setting up a Type I/Hybrid System. If you choose a preset map and still have difficulty following complete conversation, then you will have to program a Custom Fleet Map.

Note: A Hybrid System is simply a Type I System with some blocks designated as Type II blocks. Select Size Code 0 to treat the block as Type II and select others to treat as Type I.

You can select from "Preset" and "Custom".

- Preset
- Custom

Preset

If "Preset" is selected by pressing [E / yes / gps], you need to select from 16 preset Fleet Maps.

- Preset 1
- Preset 2
- :
- Preset 16

Press [E / yes / gps] to select one of the 16 preset Fleet Maps and return to the previous menu.

Custom

On the other hand, if "Custom" is selected, then you are prompted to enter the Fleet Map information.

You need to set Size Codes to all Blocks in order.

There are 8 Blocks from "Block 0" to "Block 7" and 15 Size Codes from "Size Code 0" to "Size Code 14".

In this selection, first Line displays the Block number and after second lines displays the Size Code.

```
Size Code 0
Size Code 1
Size Code 2
:
Size Code 14
```

Turn [Scroll Control] to select the Size Code. Press [E / yes / gps] to set the Size Code and proceed to the next Block setting. And press [Menu] to go back to the previous one.

Press [E / yes / gps] at the last Block to return to the previous menu with the current selection.

Press [Menu] at Block 0 to return to the previous menu. However, Size Codes once selected by pressing [E / yes / gps] are not canceled.

Motorola 800 Type I and Type II:

Select Custom and set all blocks to Size Code 0. The scanner treats this System as Motorola Type II. In other cases, it treats the System as Motorola Type I.

Note: If you change the Fleet Map setting, the ID display format will also change.

Priority ID Scan

This setting controls how the scanner treats Priority IDs.

You can select the following items.

On	The scanner scans all unlocked IDs and also checks Priority IDs.
Off	The scanner provides no special treatment for Priority IDs.

Press [E / yes / gps] to accept the selection and return to the previous menu.

Set Status Bit

This setting determines how the scanner treats the status bits.

Yes	The scanner pays attention to the status bits in the TGID.
Ignore	The scanner ignores status bits in the TGID.

Press [E / yes / gps] to accept the entry and return to the previous menu.

Set End Code

This setting determines how the scanner treats the transmission end code.

- Yes The scanner pays attention to the analog transmission end code.
- Ignore The scanner ignores the transmission end code and waits for carrier drop.

Press [E / yes / gps] to accept the selection and return to the previous menu.

Emergency Alert

The following options can be set in this menu.

- Set Alert Tone
- Set Alert Light

Press [E / yes / gps] to enter the setting.

Set Alert Tone

If "Set Alert Tone" is selected, user can determine how the scanner treats the Talk Group that set with emergency flag.

- Off The scanner ignores the emergency flag.
- Alert1-9 The scanner sounds the Emergency Alert Tone when any Talk Group goes active with the emergency flag set.

When you select "Off", the scanner returns to the previous menu.

When you select "Alert1-9", the scanner goes to the Alert Level selection.

- Auto The alert is set to the same volume as normal audio.
- Level1-15 The alert is fixed to the selected audio level.

Press [E / yes / gps] to accept the entry and return to the previous menu.

Set Alert Light

If "Set Alert Light" is selected, you can select from the following Alert Light Pattern selections.

- Off The alert light will not turn on
- On The alert light is set to on
- Slow Blink The alert light blinks slowly
- Fast Blink The alert light blinks fast

Press [E / yes / gps] to accept the entry and return to the previous menu.

Set ID Format (DEC/HEX)

You can select the format for TGIDs on MOT type system.

- Decimal Format The scanner uses decimal format for TGIDs.
- Hex Format The scanner uses hexadecimal format for TGIDs.

Press [E / yes / gps] to accept the entry and return to the previous menu.

Set ID Format (AFS/DEC)

You can select the format for TGIDs on EDACS WIDE/NARROW systems.

AFS Format The scanner uses AFS format for TGIDs.
Decimal Format The scanner uses decimal format for TGIDs.

Press [E / yes / gps] to accept the entry and return to the previous menu.

Rvw ID:Srch L/O

Allows you to review TGIDs that are locked out in ID Search or ID Scan. Any TalkGroup in this list will be skipped if encountered in ID Search or ID Scan.

This option displays "temporarily L/O IDs" and "permanently L/O IDs" without distinction.

The first Line displays "Unlock?(Y/N)" and other lines display TGIDs that are locked out. Turn the [Scroll Control] to choose TGIDs.



```
Unlock?(Y/N)
ID: 12340
ID: 11111
ID: 34567
```

Press [E / yes / gps] to unlock the TGID.
Press [. / no / pri] to advance to the next locked TGID.
Press [Menu] to return the previous menu.

If no TGIDs have been locked, the scanner displays "Nothing Locked". Press any key to return to the previous menu.

If all TGIDs are unlocked, it displays "Nothing Locked". Press any key to return to the previous menu.

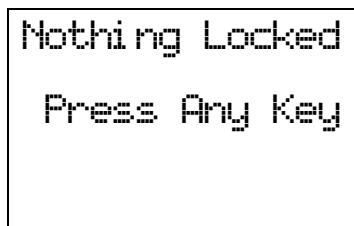

```
Nothing Locked
Press Any Key
```

Clr All L/O IDs

Selecting this causes the scanner to prompt "Confirm ?" and "Unlock All(Y/N)".

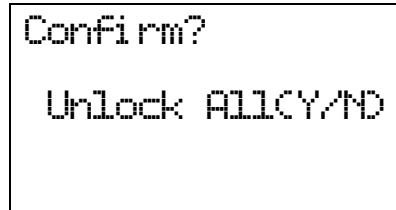

```
Confirm?  
Unlock ALL(Y/N)
```

Press [E / yes / gps] to unlock all TGIDs.

Press [. / no / pri] to cancel this selection.

The scanner returns to the previous menu.

If all TGIDs are unlocked, it displays "Nothing Locked". Then press any key to return to previous menu.

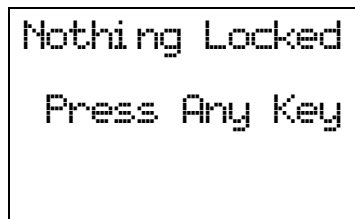

```
Nothing Locked  
Press Any Key
```

Edit Site

See *Program Site*.

Edit Group

See *Program Group*.

Copy System

You can copy the System and all associated settings by select this menu item. The scanner prompts you for a new System Name.

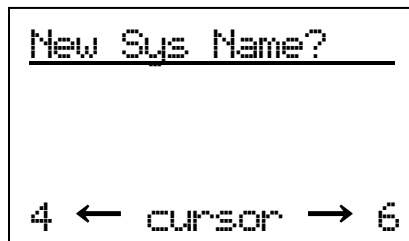

```
New Sys Name?  
4 ← cursor → 6
```

Press [E / yes / gps] to copy the System with the entered System name. The scanner goes to the *System Settings* menu with the new System active.

Note: This operation also copies all sites, Groups and Channels belonging to the System.

Delete System

You can delete the current system and all associated settings by select this menu item. The scanner prompts "Confirm Delete?" to confirm deletion.

Press [E / yes / gps] to delete the current system.

Press [. / no / pri] to cancel deletion and return to the previous menu.

Note: If you confirm to delete the system, all site, all Groups and all Channel data belonging to the System are also deleted.

Program Site

You can select an existing Site for editing or create a new Site. Site Names that already have been created are displayed as Menu Items.

Sites are sorted in the order of the Site Quick Key (See: [Set Quick Key](#)) as 1, 2,...,0,11,...99, 90 and not assigned. The order of Sites belonging to the same Quick Key is determined by the order in which they were created. "New Site" is displayed as the last menu item.

Select "New Site" and press [E / yes / gps] to create a new site.

Note: At first, only "New Site" is displayed.

The limit of Sites in a system is 256. So, if you try to select "New Site" when there are already 256 Sites, the scanner displays "Over Limit" and sounds an Error Tone.

Creating a New Site

Press [E / yes / gps] to create a new site. After a new site is created, the scanner assigns a default site name of "Site xxx-yyy TTT".

xxx: System index number,
yyy: 1-3 digit sequential site index number,
TTT: abbreviation for the site type, as follows.
MOT Type = "MOT"
EDACS WIDE/NARROW= "EDC"
LTR Type = "LTR"

Site Settings

The following site settings are possible:

- Edit Name
- Set Quick Key
- Set Startup Key
- Edit Band Plan
- Set Site Type
- Set Frequencies
- Set Modulation
- Set Attenuator
- Set Lockout
- Set Hold Time
- Set C-Ch Only
- Set LocationInfo
- Delete Site
- New Site

The items available are different for each Site Type. See [Site Settings](#) for details of the difference.

Turn [Scroll Control] knob and press [E / yes / gps] key to go to each setting.

Edit Name

You can name the site.

Refer to FONT DATA for the characters that can be entered.

Press [E / yes / gps] to accept the name entered. The scanner returns to the previous menu.

Set Quick Key

This option lets you select which Quick Key will rapidly lock/unlock the site in Scan Mode.

Turn [Scroll Control] to select the Site Quick Key. The Site Quick Key can be from "0" to "99" and "." (= Not assigned).

Press a number key to jump the cursor to the head number of ten's place. For example if you press [2 / sr2], the cursor jumps to "20".

Press [E / yes / gps] to accept and return to the previous menu.

Set Startup Key

The scanner locks or unlocks the site according to setting of this option by pressing and holding a number key at power-on or while displaying the Opening Screen.

Turn [Scroll Control] to select the Startup Key in this menu. The Startup Key can be set from "0" to "9" and "." (= Not assigned).

Press [E / yes / gps] to accept the selection and return to the previous menu.

Edit Band Plan

This menu is shown when the selected system is a MOT type system.

You can select one of three kinds of band plans:

- 800/900 Standard
- 800 Splinter
- Custom

To properly track Motorola VHF and UHF systems and rebanded 800 MHz systems, you should select "Custom" and enter what is known as the base frequencies (Lower and Upper), the spacing frequencies and channel offsets for each System.

To select the custom Band Plan number, turn the [Scroll Control] to select its number from 1 to 6.

- Band Plan 1
- Band Plan 2
- Band Plan 3
- Band Plan 4
- Band Plan 5
- Band Plan 6

Then press[E / yes / gps]. You are then prompted to set the detailed information of band plan.

- Set Base Freq
- Set Offset
- Set Spacing

When you select “Set Base Freq”, you are then prompted to “Input Lower” then “Input Upper”. Use the number keys and decimal key to input frequencies. Press [E / yes / gps] to set the frequency. If the entered frequency is out of band, “Out of Band” will be shown with an error tone. Press any key to go back to editing the base frequency.

When you select “Set Offset”, you can set the channel offset for the band plan entry. You can set the Offset from -1023 to +1023. Enter the absolute value using the number keys. If you input a value over 1023, “Out of Range” and “Set Max? (Y/N)” will be shown. Press [. / no / pri] to return to editing state. Press [E / yes / gps] to set the value to maximum number (1023) and you will be prompted to “Select Polarity”. Select “+ Polarity” or “- Polarity”, then press [E / yes / gps] to confirm the setting.

When you select “Set Spacing”, the following spacing values can be selected:

5.00 kHz	6.25 kHz	10.00 kHz	12.50 kHz	15.00 kHz
18.75 kHz	20.00 kHz	25.00 kHz	30.00 kHz	31.25 kHz
35.00 kHz	37.50 kHz	40.00 kHz	43.75 kHz	45.00 kHz
50.00 kHz	55.00 kHz	56.25 kHz	60.00 kHz	62.50 kHz
65.00 kHz	68.75 kHz	70.00 kHz	75.00 kHz	80.00 kHz
81.25 kHz	85.00 kHz	87.50 kHz	90.00 kHz	93.75 kHz
95.00 kHz	100.00 kHz			

Turn the [Scroll Control] to select. Press [E / yes / gps] to set the Spacing.

Note: If Base Freqs haven’t been set yet, the setting of Offset and Spacing will not be accepted.

For rebanded systems, the most likely settings for Base (Lower and Upper), Offset and Spacing in the table are:

Band Plan	Base Freq (Lower)	Base Freq (Upper)	Offset	Polarity	Spacing
1	851.025MHz	854.000MHz	440	+	25 kHz
2	851.0125MHz	868.9875MHz	0	+	25 kHz

Set Site Type

You can select the site type for EDACS WIDE/NARROW system.

Wide(Standard)	EDACS wide site
Narrow	EDACS narrow site

Press [E / yes / gps] to accept and return to the previous menu.

Set Frequencies

You can select a stored frequency or enter a new system frequency.

Frequencies already set are displayed as a Menu Item and "New Frequency" is displayed as the last one.

For example, if you have stored "851.0125MHz" and "868.9875MHz", the selectable items are as follows:

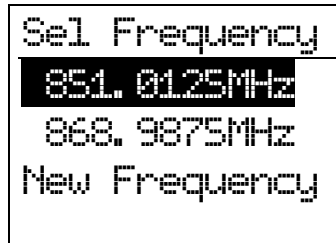

Note: At first, only "New Frequency" is displayed.

The limit of trunk frequencies in a site is 500 - 1000. You can store up to 1000 total TGID and trunk frequencies. When it is over the limit, the scanner sounds an Error Tone.

If "New Frequency" is selected by pressing [E / yes / gps], the scanner skips the next selection. Then it goes to Edit Frequency menu automatically to enter the frequency.

If you select a stored frequency and press [E / yes / gps], the scanner prompts for the next setting items.

- Edit Frequency
- Set Number Tag*
- Set Lockout
- Volume Offset (SCAT systems only)
- Delete Frequency
- New Frequency

Turn [Scroll Control] and press [E / yes / gps] to go to each setting.

*This setting is displayed only when the system type is "EDCS SCAT".

Edit Frequency

You can enter or edit the frequency by pressing the number keys and decimal key.

Press [E / yes / gps] to store the frequency.

The scanner does not allow frequency duplication in a System. If the entered frequency is already stored into that System, the scanner sounds an Error Tone and displays "Frequency Exists".

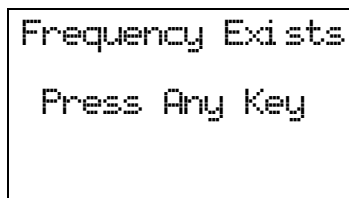

Then press any key to return to the editing mode.

Valid frequency ranges are in Band Coverage. If the entered frequency is out of range, the scanner sounds an Error Tone and displays "Out of Band". And the scanner stays on this state.

If the type of System is EDACS WIDE/NARROW or LTR, the scanner prompts for a LCN (logical channel number). Press [0 - 9] to enter the LCN.

Note: You can only enter the LCN suitable for each System type. EDACS: 1-30, LTR: 1-20.

Press [E / yes / gps] to store the LCN and return to the previous menu. The scanner does not allow LCN duplication in a System. If the entered LCN is already stored, the scanner sounds an Error Tone and displays "LCN Exists".

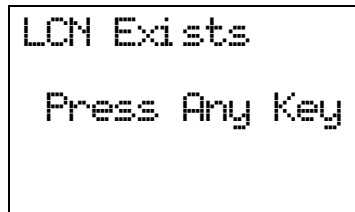

Set Number Tag

The channel Number Tag can be set in this menu.

Press a number key to input the number tag. Press [./no/pri] to clear the input.

Press [E / yes / gps] to accept the setting and return to the previous menu.

Note: The valid setting range is from 0 to 999. Blank means a number tag not assigned.

This option is only shown when system type is EDACS SCAT.

Set Lockout

This option allows you to lock or unlock the current frequency. When the frequency is locked out, the scanner does not check it.

Unlocked	The frequency is unlocked.
Temporary L/O	The frequency is temporarily locked out.
Lockout	The frequency is locked out.

Press [E / yes / gps] to accept the selection and return to the previous menu.

Volume Offset (SCAT systems only)

This option is used to set a volume offset for each site frequency. The feature can let you adjust the volume level relative to other channels when the frequency is active. Setting level are:

- 3
- 2
- 1
- 0
- +1
- +2
- +3

Press [E / yes / gps] to accept the selection and return to the previous menu.

Delete Frequency

You can delete the current frequency and all associated settings by select this menu item. The scanner prompts "Confirm Delete?" to confirm deletion.

Press [E / yes / gps] to delete the current frequency.

Press [. / no / pri] to cancel deletion and return to the previous menu.

New Frequency

Press [E / yes / gps] to create a new frequency and go to Set Frequencies.

Set Modulation

You can select the modulation from following settings.

- Auto* The scanner uses the modulation normal for the frequency's band.
- NFM The scanner uses Narrowband FM demodulation.
- FM The scanner uses FM demodulation.

Press [E / yes / gps] to accept the entry and return to the previous menu.

*If the system type is "MOT", "LT" or "EDCS SCAT", when the default modulation of the frequency in Band Defaults is not FM or NFM, the scanner will operate as FM.

Set Attenuator

You can attenuate RF reception on the frequency.

- On The frequency will be attenuated.
- Off The frequency will not be attenuated.

Press [E / yes / gps] to accept the selection and return to the previous menu.

Set Lockout

This option allows you to lock or unlock the current site. When the site is locked out, the scanner does not check it.

Unlocked	The site is unlocked.
Temporary L/O	The site is temporarily locked out.
Lockout	The site is locked out.

Press [E / yes / gps] to accept the selection and return to the previous menu.

Set Hold Time

In Trunked Systems, this setting is applied only when a Control Channel can be received.

If no Control Channel can be received, the scanner goes to the next system immediately.

You change this setting from 0 to 255 seconds by pressing the number keys.

Press [E / yes / gps] to accept the entry and return to the previous menu.

If you enter over "255" for the Hold Time, the scanner prompts "Out of Range" and "Set Max? (Y/N)". When [E / yes / gps] is pushed, maximum value 255 will be set.

It returns to the edit state, if you press [. / no / pri].

Set C-Ch Only

You can select how the scanner tracks Motorola Systems. (C-Ch means control channel.)

- On The scanner can track Motorola System by entering only the system control channels. You will not have to program the voice channels.
- Off You need to enter the control channel and voice channels.

Press [E / yes / gps] to accept the entry and return to the previous menu.

Set LocationInfo

You can set the location data for the current site.

The setting items are:

- Set Latitude
- Set Longitude
- Set Range
- Set GPS Enable

Turn [Scroll Control] to select the item and Press [E / yes / gps] to go to the settings.

Set Latitude

Press the number keys to enter latitude data. Press any number key when the cursor is in the last position to toggle between south latitude (S) and the north latitude (N).

Press [E / yes / gps] to accept and return to the previous menu.

If "DMS:DDD°MM'SS.ss" is selected in Set Pos Format, the display is the following.

```
Set Latitude
-----
00°00' 00.00  N
```

If "DEG:DDD.dddddd" is selected in Set Pos Format, the display is the following.

```
Set Latitude
-----
00.000000  N
```

Set Longitude

Press the number keys to enter longitude data. Press any number key when the cursor is in the last position to toggle between east longitude (E) and west longitude (W).

Press [E / yes / gps] to accept and return to the previous menu.

If "DMS:DDD°MM'SS.ss" is selected in Set Pos Format, the display is the following.

```
Set Longitude
-----
00°00' 00.00  W
```

If "DEG:DDD.dddddd" is selected in Set Pos Format, the display is the following.

```
Set Longitude
-----
00.000000  W
```

Set Range

In this menu, the setting unit is determined by the setting in Set Unit.

When you select "mile" in Set Unit, the displayed unit will be mile.

When you select "km" in Set Unit, the displayed unit will be km.

The valid setting range is from 0.5 to 125.0, in 0.5 steps.

Press [E / yes / gps] to accept the setting and return to the previous menu.

Set GPS Enable

When this option is set to "On", the scanner will control L/O status of this site by position information received from a GPS.

On The L/O state of this site is automatically controlled by position information.

Off The L/O state of this site is not influenced by GPS.

Press [E / yes / gps] to accept and return to the previous menu.

Delete Site

You can delete the current site and all associated settings by select this menu item. The scanner prompts "Confirm Delete?" to confirm deletion.

Press [E / yes / gps] to delete the current site.

Press [. / no / pri] to cancel deletion and return to the previous menu.

New Site

Press [E / yes / gps] to create a New Site and goes to Creating a New Site.

Program Group

This menu lets you select a Channel Group for programming or create a new Channel Group.

Names of Groups already created are displayed as Menu Items. The order of Groups is sorted by setting of Quick Key for Groups (See: [Set Quick Key](#)) as 1, 2, 3, ... , 9, 0 and "." (=Not assigned). The order of Groups belonging to same Quick Key is determined by the assigned order. "New Group" is displayed as the last item.

For example, there are two groups named "Group 1" and "Group 2", selectable items are as follows:

- Group 1
- Group 2
- New Group

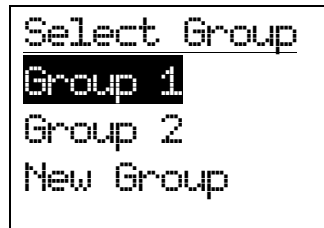

Note: At first, only "New Group" is displayed.

The limit of Groups in a System is 20. So, if you try to select "New Group" when there are already 20 Groups in that System, the scanner displays "Over Limit" and sounds an Error Tone. Then it returns to Group selection.

Select the Group Name or "New Group" and press [E / yes / gps] to go to the Group Settings Menu.

If the "New Group" is selected, the scanner appends a Group to the System with a default Group name of "Group xx". (xx: 1-2 digits sequential number)

Group Settings

This menu has following group settings:

- Edit Name
- Set Quick Key
- Edit Channel
- Set LocationInfo
- Set Lockout
- Delete Group
- New Group

Note: The name of the Group will be shown in the first line of the display.

Press [E / yes / gps] to go to each setting.

Edit Name

Here, you can name the Channel Group.

Refer to FONT DATA for the characters that can be entered.

Press [E / yes / gps] to accept the name entered. The scanner returns to the previous menu.

Set Quick Key

This option lets you select which Group Quick Key will rapidly enable/disable the Group when the scanner is in the scanning mode.

Allowed settings are from 0 to 9 and not assigned. You can assign more than one Channel Group to the same Quick Key.

Press [1 – 9, 0] to assign each number as a Group Quick Key.

Press [. / no / pri] to assign to no Group Quick Key.

Press [E / yes / gps] to accept and return to the previous menu.

Edit Channel

See: *Program Channel*.

Set LocationInfo

You can set location data for the current channel group so it is automatically locked and unlocked as you change location (when using an external GPS).

You set the following items:

- Set Latitude
- Set Longitude
- Set Range
- Set GPS Enable

Turn [Scroll Control] to select an item to set and press [E / yes / gps] to go to the settings.

Set Latitude

Enter the latitude data using the number keys.

Press any number key when the cursor is in the last position to toggle between south latitude (S) and north latitude (N).

Then press [E / yes / gps] to accept and return to the previous menu.

If “DMS:DDD⁰MM'SS.ss” is selected in *Set Pos Format*, the display is the following.

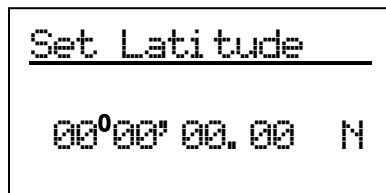

If “DEG:DDD.dddddd” is selected in Set Pos Format, the display is the following.

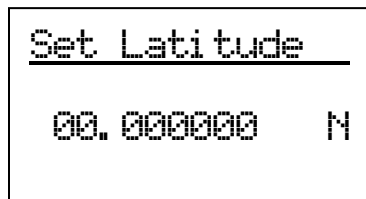

A screenshot of a menu titled "Set Latitude" with a horizontal line underneath. Below the line, the text "00.000000 N" is displayed in a monospaced font.

Set Longitude

Enter the longitude data using the number keys.

Press any number key when the cursor is in the last position to toggle between west longitude (W) and east longitude (E).

Then press [E / yes / gps] to accept and return to the previous menu.

If “DMS:DDD°MM'SS.ss” is selected in Set Pos Format, the display is the following.

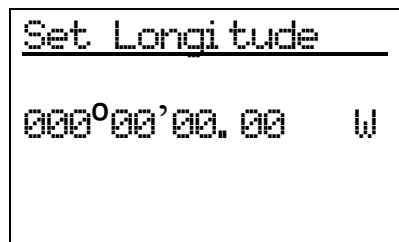

A screenshot of a menu titled "Set Longitude" with a horizontal line underneath. Below the line, the text "000°00'00.00 W" is displayed in a monospaced font.

If “DEG:DDD.dddddd” is selected in Set Pos Format, the display is the following.

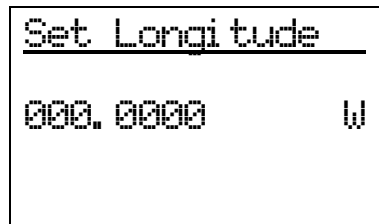

A screenshot of a menu titled "Set Longitude" with a horizontal line underneath. Below the line, the text "000.0000 W" is displayed in a monospaced font.

Set Range

In this menu, the setting unit depends on the setting in Set Unit.

When you select “mile” in Set Unit, the displayed unit is mile.

When you select “km” in Set Unit, the displayed unit is km.

The valid setting range is from 0.5 to 125.0 in 0.5 steps.

Press [E / yes / gps] to accept the setting and return to the previous menu.

Set GPS Enable

When this option is set to "On", the scanner will control the L/O status of this channel group using position information supplied from a connected GPS.

- On The Channel Group's L/O state is automatically controlled by position information.
- Off The Channel Group's L/O state is not influenced by GPS.

Press [E / yes / gps] to accept and return to the previous menu.

Set Lockout

This option allows you to lock or unlock the current channel group. When the channel group is locked out, the scanner does not check it.

- Unlocked The channel group is unlocked.
- Temporary L/O The channel group is temporarily locked out.
- Lockout The channel group is locked out.

Press [E / yes / gps] to accept the selection and return to the previous menu.

Delete Group

You can delete the current channel group and all associated settings by select this menu item. The scanner prompts "Confirm Delete?" to confirm deletion.

Press [E / yes / gps] to delete the current channel group.

Press [. / no / pri] to cancel deletion and return to the previous menu.

New Group

Press [E / yes / gps] to create a new group and go to Group Settings.

Program Channel

You can select a Channel for programming or add a new Channel.

Names of Channels already added are displayed as Menu Items. The order of Channels is sorted by created or pasted order. "New Channel" is displayed as the next to last Channel. "Paste Channel" will be displayed as the last item if a Channel has previously been copied from a compatible (same typed) System / Site.

For example, there are the Channel named "Channel A" and a Channel was copied, selectable items are as follows:

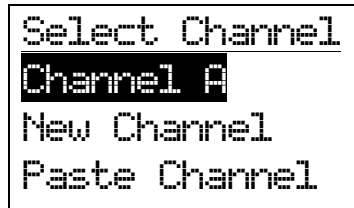

Note: At first, only "New Channel" is displayed.

For conventional systems, the limit of Channels for one system is 1000. So, if you select "New Channel" and enter a frequency when there are already 1000 channels in the system, the scanner displays "Over Limit" and sounds an Error Tone. Then it returns to channel selection.

For trunked Systems, the limit of Channels for one system is 500. So, if you select "New Channel" and enter a TGID when there are already 500 Channels in the system, the scanner displays "Over Limit" and sounds an Error Tone. Then it returns to Channel selection.

The limit of Channels and System frequencies is 9000. If you select "New Channel" and enter the frequency or TGID when there are already 9000 Channels and System frequencies, the scanner displays "Over Limit" and sounds an Error Tone. Then it returns to Channel selection.

Select the Channel Name and press [E / yes / gps] to go to the Channel Settings Menu.

Select "Paste Channel" and press [E / yes / gps] to paste the Channel. All settings are copied, then the scanner goes to the Channel Settings Menu.

If the "New Channel" is selected by pressing [E / yes / gps], you need to enter the frequency for a conventional System's Channel or the TGID for a trunked system Channel.

Input Frequency:

You must enter a frequency.

Note: Please see: Band Coverage for acceptable frequencies.

Press [E / yes / gps] to set the frequency. The channel name is set to the frequency as a default name as "xxxx.xxxxMHz". Then the scanner goes to the Channel Settings Menu.

Press [Menu] to return to the previous selection and cancel adding a Channel.

Input TGID:

You must enter a TGID.

You can input only a TGID in the format suitable for the site type.

Motorola Type ID (Decimal Format ID) :

When the custom Fleet Map setting for a MOT system is not all Size Code 0 for Blocks, the scanner treats the System as a Motorola Type I.

Press the number keys to enter the Block number, Fleet number and SubFleet number.

Press the decimal key to enter a hyphen.

Note: 1 digit Block number, 2 - 3 digits Fleet number, hyphen and 1 - 2 digits SubFleet number.

When the set Preset Fleet Map or custom Fleet Map has all Blocks with Size Code 0, the scanner treats the System as a Motorola Type II.

Press the number keys to enter the TGID.

Note: Numbers only (up to 5 digits)

Motorola Type ID (Hex Format ID) :

Turn [Scroll Control] to select Hex character from "0" to "F".

Press [4 / LEFT / ifx] or [6 / RIGHT / disp] to move cursor left or right.

Press [E / yes / gps] to set the Hex ID.

Note: When the custom Fleet Map setting set to Size Code 0 for all Blocks, the scanner treats the System as a Motorola Type I or Hybrid system. In these cases Hexadecimal input will be treated as same as Decimal ID. (see *FLEET MAP* for detail)

E.g. If you enter "1", "2" as a Type I Hex ID, it will be treat as 12, not 0x12.

EDACS ID :

For EDCS Wide/Narrow systems.

Press the number keys to enter the Agency number.

Press the decimal key to enter a hyphen.

Press the number keys to enter the Fleet number and SubFleet number.

Note: Agency number (00 - 15), hyphen, Fleet number (00 - 15) and SubFleet number (0 - 7)

The scanner does not accept all zero ID ("00-000").

You can omit the SubFleet number as a wildcard.

You can omit Fleet numbers and SubFleet numbers as wildcards.

LTR ID :

For LTR systems.

Press the number keys to enter the Area code, Home repeater and User ID.

Note: 6 digit numbers; Area code (0 or 1), Home repeater (01 - 20), User ID (000 - 254)

I-Call (Motorola, EDACS) :

For any MOT System, EDCS Wide and Narrow System.

First, press the decimal key to enter "i" for I-Call. Then press the number keys to enter the ID.

Note: For details of TGID format, please see: *TGID FORMAT FOR TRUNKED SYSTEM*.

Press [E / yes / gps] to set the TGID. The Channel Name is set to the TGID as default name as "ID:xxxx".
Then the scanner goes to the Channel Settings Menu.

Press [Menu] to return to the previous selection and cancel adding a Channel.

Channel Settings

The following settings are available for channels.

- Edit Name
- Edit Frequency
- Edit TGID
- Set CTCSS/DCS
- Set Number Tag
- Set Modulation
- Set Attenuator
- Set Priority
- Set Alert
- Set Lockout
- Volume Offset
- Copy Channel
- Delete Channel
- New Channel

The specific settings available depend on the current system type.

See [Channel Settings](#) for details of the differences.

Note: The first Line in the display shows the name of the Channel in Menu Display.

Edit Name

You can provide a name for the channel.

Refer to FONT DATA for the characters that can be entered.

Press [E / yes / gps] to accept the name entered. The scanner returns to the previous menu.

Edit Frequency

If you select to edit the frequency, the scanner displays the current frequency in edit mode.

See [Edit Frequency](#).

Edit TGID

If you select to edit the TGID, the scanner displays the current ID. You can use the keypad to change the ID.

When you press [E / yes / gps] to accept, the scanner checks for valid data and returns to the previous menu.

If the ID is invalid, the scanner shows “Bad TGID” and “Press Any Key” and sounds an error tone. Press any key to return to the editing state.

Set CTCSS/DCS

You can set the CTCSS/DCS options from the following items for conventional systems.

Off	The scanner ignores all tones and opens squelch on any signal.
Search	The scanner displays any tone being used, but opens squelch on any signal.
CTCSS	The scanner prompts you for the appropriate setting. Squelch will open for this Channel only if the code matches.
DCS	The scanner prompts you for the appropriate setting. Squelch will open for this Channel only if the code matches.
Set Lockout	The scanner prompts you to select CTCSS/DCS settings to ignore. Squelch will not open for this Channel only if the code matches.

*For AM or WFM modulation, this setting will be ignored.

If you select “Off” or “Search”:

The scanner returns to the previous menu.

If you select “CTCSS” or “DCS”:

You can select the CTCSS frequency or DCS code. (Refer to *CTCSS FREQUENCY* and *DCS CODE* for selectable frequencies and codes.)

Turn [Scroll Control] to select.

Press [E / yes / gps] to set and return to the previous menu.

If you select “Set Lockout”:

You can select a CTCSS or DCS for lockout.

Turn [Scroll Control] to select and press [E / yes / gps] key to lock it out. Then the scanner returns to the previous menu.

Set Number Tag

The Channel Number Tag can be set in this menu.

Press a number key to input the number tag. Press [./no/pri] to clear the input.

Press [E / yes / gps] to accept the setting and return to the previous menu.

Note: The valid setting range is from 0 to 999. Blank means a number tag not assigned.

Set Modulation

You can select the modulation from the following settings.

Auto	The scanner uses the modulation normal for the frequency’s band. (See: <u><i>Band Defaults</i></u>)
AM	The scanner uses AM demodulation.
NFM	The scanner uses Narrowband FM demodulation.
FM	The scanner uses FM demodulation.
WFM	The scanner uses Wideband FM demodulation.
FMB	The scanner uses FM Broadcast demodulation.

Press [E / yes / gps] to accept the entry and return to the previous menu.

Set Attenuator

You can attenuate RF reception on the frequency.

- On The frequency will be attenuated.
- Off The frequency will not be attenuated.

Press [E / yes / gps] to accept the selection and return to the previous menu.

Set Priority

This option sets the Channel as a Priority Channel. You can set this On for each Channel independently. See PRIORITY SCAN to see how this works for conventional. See PRIORITY ID SCAN to see how this works for trunking.

- On The Channel is treated with priority.
- Off The Channel is not treated with priority.

Press [E / yes / gps] to accept the entry and return to the previous menu.

Note: Although any conventional frequency can be set as a priority channel, the scanner is unable to scan over the number of priority channels that was set at menu MaxCHs/Pri-Scan. If unlocked priority channels are over this setting, only that portion of the priority channels will be scanned for priority.

Set Alert

Channel alert options can be set using this menu.

- Set Alert Tone
- Set Alert Light

Press [E / yes / gps] to enter the setting.

Set Alert Tone

You can select whether the scanner should sound an Alert Tone when this Channel becomes active*.

- Off No alert sounds.
- Alert 1-9 The scanner sounds Alert1-9 with the Channel becomes active.

If you select "Off", the scanner returns to the previous menu.

If you select "Alert1-9", the scanner goes to Alert Level selection.

- Auto The alert is set to the same volume as normal audio.
- Level1-15 The alert is fixed to the selected audio level.

Press [E / yes / gps] to accept the entry and return to the previous menu.

Set Alert Light

You can select whether the scanner should have an alert light when this Channel becomes active*.Alert Light Pattern selections.

Off	The alert light will not turn on
On	The alert light is set to on
Slow Blink	The alert light blinks slowly
Fast Blink	The alert light blinks fast

Press [E / yes / gps] to accept the entry and return to the previous menu.

*"Active" means that the scanner received a signal on the Channel in Scan Mode or Scan Hold Mode, or the Channel is selected in Scan Hold Mode.

Set Lockout

This option allows you to lock or unlock the current channel. When the channel is locked out, the scanner does not check it.

Unlocked	The channel is unlocked.
Temporary L/O	The channel is temporarily locked out.
Lockout	The channel is locked out.

Press [E / yes / gps] to accept the selection and return to the previous menu.

Volume Offset

This option is used to set a volume offset for each channel. The feature can let you adjust the volume level relative to other channels when the frequency is active. Setting level are:

- 3
- 2
- 1
- 0
- +1
- +2
- +3

Press [E / yes / gps] to accept the selection and return to the previous menu.

Copy Channel

You can copy a Channel and all associated settings by selecting this menu item.

The Channel Information is copied to the Copy Buffer when this item is selected. The Copy Buffer just has the last copied Channel Information.

The scanner displays "Copy Channel" and "Copied to Buffer" when you press [E / yes / gps].

Note: Pasting a Channel will not clear this Copy Buffer (See: Edit Channel)

Delete Channel

You can delete the current channel and all associated settings by select this menu item. The scanner prompts "Confirm Delete?" to confirm deletion.

Press [E / yes / gps] to delete the current channel.

Press [. / no / pri] to cancel deletion and return to the previous menu.

New Channel

Press [E / yes / gps] to create a New Site and go to *Channel Settings*.

Program Location

You can select the any Location for programming or create a new Location.

First, select the location type to edit or create from the following types:

- POI
- Dangerous Xing
- Dangerous Road

Select an existing location or New Location. For a POI, it goes to POI Settings. For a “Dangerous Xing” or “Dangerous Road”, it goes to Dangerous Xing / Road Settings.

Note: You can review all created Locations in Review Location Mode. (See Review Location Mode.)

POI Settings

You can set the following items.

- Edit Name
- Set Type
- Set Alert
- Set LocationInfo
- Set Range
- Set Lockout
- Delete Location
- New Location

Turn [Scroll Control] and press [E / yes / gps] to go to each setting.

Dangerous Xing / Road Settings

You can set the following items.

- Edit Name
- Set Type
- Set Alert Volume
- Set Alert Light
- Set LocationInfo
- Set Heading
- Set Speed Limit
- Set Lockout
- Delete Location
- New Location

Turn [Scroll Control] and press [E / yes / gps] to go to each setting.

Edit Name

You can name the location.

Refer to FONT DATA for the characters that can be entered.

Press [E / yes / gps] to accept the name entered. The scanner returns to the previous menu.

Set Type

This option can be used to select the location type.

- POI
- Dangerous Xing
- Dangerous Road

Turn [Scroll Control] to select the type and press [E / yes / gps] to accept it.

Then the scanner returns to the previous menu.

Set Alert

Set Alert Tone

You can select whether the scanner should sound an Alert Tone when approaching the set Location.

- | | |
|-------------|---|
| Off | No alert sounds. |
| Alert 1 - 4 | The scanner sounds Alert1 - 4 when you approach the Location. |

If you select "Off", the scanner returns to the previous menu.

If you select "Alert1 - 4", the scanner goes to the Alert Level selection.

- | | |
|-------------|--|
| Auto | The alert is set to the same volume as normal audio. |
| Level1 - 15 | The alert is fixed to the selected audio level. |

Set Alert Light

You can select whether the scanner should have an Alert Light when you approach the set Location.

Alert Light Pattern selections.

- | | |
|------------|----------------------------------|
| Off | The alert light will not turn on |
| On | The alert light is set to on |
| Slow Blink | The alert light blinks slowly |
| Fast Blink | The alert light blinks fast |

Press [E / yes / gps] to accept the entry and return to the previous menu.

Note: This setting menu appears only in "POI".

Set Alert Volume

This option can be used to set the alert level.

- | | |
|-----------|--|
| Auto | The alert is set to the same volume as normal audio. |
| Level1-15 | The alert is fixed to the selected audio level. |
| Off | No alert sounds. |

Press [E / yes / gps] to accept the data and return to the previous menu.

Note: This setting menu appears in "Dangerous Xing" and "Dangerous Road".

Set Alert Light

This option can be used to set Alert Light.

Alert Light Pattern selections.

Off	The alert light will not turn on
On	The alert light is set to on
Slow Blink	The alert light blinks slowly
Fast Blink	The alert light blinks fast

Press [E / yes / gps] to accept the entry and return to the previous menu.

Note: This setting menu appears in “Dangerous Xing” and “Dangerous Road”.

Set LocationInfo

You use this option to set the location data.

First, you set the latitude.

Press the number keys to enter latitude data. Press any number key when the cursor is in the last position to toggle between south latitude (S) and the north latitude (N).

Press [E / yes / gps] to go to the longitude setting.

Press the number keys to enter longitude settings. Press any number key when the cursor is in the last position to toggle between east longitude (E) and west longitude (W).

Press [. / no / pri] to jump to the next input area. For example, press [. / no / pri] on Degree Number for DMS to jump to the Minute Number. Press this again to jump to the second number. Press [. / no / pri] or a number key on N/S or W/E to toggle these settings.

Set Range

This option sets the range for a POI.

In this menu, the setting unit depends on the setting in Set Unit.

When you select “mile” in Set Unit the displayed unit will be miles.

When you select “km” in Set Unit the displayed unit will be kms.

The valid setting range is from 0.05 to 4.0, by 0.05 steps.

Press [E / yes / gps] to accept the setting and return to the previous menu.

Note: This setting menu appears only in “POI”.

Set Heading

This option sets the heading direction-based alerts.

The options are:

All Range	The scanner always sounds an alert and turns on the Alert Light when you go into range of the location.
North (0°)	South (180°)
NE (45°)	SW (225°)
East (90°)	West (270°)
SE (135°)	NW (315°)

Press [E / yes / gps] to accept the and return to the previous menu.

Note: This setting menu appears in “Dangerous Xing” and “Dangerous Road”.

Set Speed Limit

This option sets the speed limit for location alerts. The scanner only alerts when your speed is over this setting.

In this menu, the setting unit depends on the setting in Set Unit.

When you select “mile” in Set Unit the displayed unit will be “mph”.

When you select “km” in Set Unit the displayed unit will be “km/h”.

The valid setting range is from 0 to 200, in steps of 1.

Press [E / yes / gps] to accept the entry and return to the previous menu.

Note: This setting menu appears in “Dangerous Xing” and “Dangerous Road”.

Set Lockout

This option allows you to lock or unlock the current location. When the location is locked out, the scanner does not check it.

Unlocked	The location is unlocked.
Temporary L/O	The location is temporarily locked out.
Lockout	The location is locked out.

Press [E / yes / gps] to accept the selection and return to the previous menu.

Delete Location

You can delete the current location and all associated settings by select this menu item. The scanner prompts "Confirm Delete?" to confirm deletion.

Press [E / yes / gps] to delete the current location.

Press [. / no / pri] to cancel deletion and return to the previous menu.

New Location

If you select this in the “POI” setting menu and press [E / yes / gps], the scanner creates a New POI and goes to *POI Settings*.

Or, if you select this item in “Dangerous Xing” or “Dangerous Road”, the scanner creates a New Dangerous location and goes to *Dangerous Xing / Road Settings*.

Srch/CloCall Opt

This menu includes the following:

- Freq Lockouts
- Broadcast Screen
- CTCSS/DCS Search
- Repeater Find
- Max Auto Store
- Set Delay Time
- Set Attenuator

Press [E / yes / gps] to go to each setting.

Each setting in these options is applied to some or all Search Modes*.

*"Search Mode" is Service Search, Custom Search, Quick Search, Search and Store, Close Call and CC Auto Store.

The mode in which a setting is applied showed in the following table.

	Service Search*1	Custom Search*1	Quick Search	Search and Store	Close Call	CC Auto Store	CC Hits System	Band Scope
Freq Lockouts	0	0	0	0	0	0		
Broadcast Screen		0	0	0 ^{*2}	0	0		
CTCSS/DCS Search	0	0	0	0	0	0		
Repeater Find		0	0		0			
Max Auto Store				0		0		
Set Delay Time			0		0		0	
Set Attenuator			0		0	0		0

*1While searching a search range in Search with Scan, these settings are valid.

*2In Search and Store, this setting is valid only when the scanner stores a Custom Search frequency.

Freq Lockouts

You can select from these items.

- Unlock All
- Rvw Search L/O

Press [E / yes / gps] to enter each menu.

Unlock All

Selecting this causes the scanner to prompt "Confirm?" and "Unlock All(Y/N)".

Press [E / yes / gps] to unlock all frequencies. Then the scanner returns to *Freq Lockouts*.

Press [. / no / pri] to cancel this and return to the previous menu.

Note: If no frequencies have been locked, the scanner displays "Nothing Locked".

Press any key to return to the previous menu.

Rvw Search L/O

Allows you to review frequencies that are locked out in Search Mode or Close Call Mode. Any frequency in this list will be skipped if encountered in these modes.

The first Line displays "Unlock?(Y/N)" and the remaining lines display locked out frequencies.

Turn [Scroll Control] to choose frequencies.

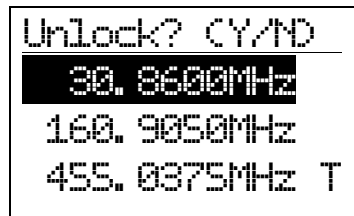

“T” will be displayed following the frequency if it is a temporary lockout frequency.

Press [E / yes / gps] to unlock the displayed frequency and change to the next locked out frequency.

Press [. / no / pri] to advance to the next locked out frequency.

Press [Menu] to return the previous menu.

Note: If no frequencies have been locked, the scanner displays "Nothing Locked".

If you unlock the last frequency, the scanner displays "Nothing Locked".

Broadcast Screen

This option sets whether the scanner screens broadcast frequencies.

You can select the following items.

- Set All Band On
- Set All Band Off
- Set Each Band
- Program Band

Press [E / yes / gps] to enter each menu.

Set All Band On

This function can turn all bands On.

When you press [E / yes / gps], the scanner displays “All Band” and “On”.

The scanner then returns to the previous menu.

Set All Band Off

This function can turn all bands Off.

When you press [E / yes / gps], the scanner displays “All Band” and “Off”.

The scanner then returns to the previous menu.

Set Each Band

You can turn on or off each of the following bands.

Pager	:	On/Off	:	Various, according to FCC allocation
FM	:	On/Off	:	88.1000 - 107.9000 MHz
UHF TV	:	On/Off	:	470.0000 - 512.0000 MHz
VHF TV	:	On/Off	:	54.0000 - 72.0000 MHz
			:	76.0000 - 88.0000 MHz
			:	174.0000 - 216.0000 MHz
NOAA WX	:	On/Off	:	161.6500, 161.7750, 162.4000, 162.4250, 162.4500, 162.4750, 162.5000, 162.5250, 162.5500, 163.2750 MHz
Band 1	:	On/Off		
Band 2	:	On/Off		
:				
Band 10	:	On/Off		

On The scanner ignores hits on the band frequencies.

Off The scanner does not Screen for the band frequencies.

Turn [Scroll Control] to put the cursor focus on the band that you want to change, and press [E / yes / gps] to change the setting.

Then press [Menu] to return to the previous menu.

Program Band

You can set up to 10 custom band screens. Select a band and press [E / yes / gps] to go to the limit setting.

You need to set a lower and upper limit frequency. First, enter the lower limit frequency and store it by pressing [E / yes / gps]. Next, enter the upper limit frequency and press [E / yes / gps] to store the upper limit. The scanner returns to the previous menu.

Note: If the lower frequency is larger than the upper frequency, the setting is automatically changed.

CTCSS/DCS Search

This option sets whether the scanner will search for a CTCSS/DCS code when it finds an active frequency.

Off The scanner does not search for CTCSS/DCS codes.

On The scanner searches for CTCSS/DCS codes. If the scanner detects the code, it displays the found code.

Press [E / yes / gps] to set this setting and return to the previous menu.

Note: For AM, WFM or FMB modulation, this setting is ignored and the scanner treats this setting as "Off".

Repeater Find

This option sets whether the scanner attempts to locate the transmission on a repeater output frequency when it detects a transmission on a common repeater input frequency.

- On The scanner automatically applies repeater reverse to detected transmissions. If the scanner can detect the transmission on the output frequency, it displays "Repeater Found" on the display, and remains on the output frequency. If it does not detect the transmission on the output frequency or it lost the found signal, the scanner remains on the transmission on the original frequency.
- Off The scanner does not perform Repeater Find.

Press [E / yes / gps] to set this setting and return to the previous menu.

Note: You cannot lock out the Repeater frequency. And Repeater frequencies are not related to the locked out frequency list of *Freq Lockouts*.

Max Auto Store

This setting controls how many hits the scanner will automatically store in either Search and Store or Close Call Auto Store.

When the scanner has saved the maximum number of hits set by this setting, it stops storing.

When there are already more auto-stored Channels than the number of Max Auto Store, the scanner will not perform Auto Store operation.

The valid setting range is from 1 to 256.

Press the number keys to enter the number.

Press [E / yes / gps] to set this setting. Then return to previous menu.

If you enter 0, the scanner prompts "Out of Range" and " Set Min? (Y/N)". Press [E / yes / gps] to set the value to minimum "1". Or, press [. / no / pri] to return to editing state and the entered value is set to "1".

If you enters over 256, the scanner prompts "Out of Range" and "Set Max? (Y/N)". Press [E / yes / gps] to set the value to maximum "256". Or, press [. / no / pri] to return to editing state and the entered value is set to "256".

Set Delay Time

This setting controls how long the scanner stays on frequency after a transmission ends before resuming searching.

Turn [Scroll Control] to select the delay time setting from the following list:

- 10 sec
- 5 sec
- 2 sec
- 0 sec
- 1 sec
- 2 sec
- 5 sec
- 10 sec
- 30 sec

Then press [E / yes / gps] to accept and return to the previous menu.

Set Attenuator

You can select to attenuate RF reception on all frequencies in the search range.

- On The frequencies are attenuated.
- Off The frequencies are not attenuated.

Press [E / yes / gps] to accept the entry and return to the previous menu.

Search for...

This menu includes the following items.

- Service Search
- Edit Service
- Custom Search
- Edit Custom
- Search and Store
- Set Search Key

Press [E / yes / gps] to enter each item.

Service Search

You can select from 12 preset search bands for searching.

- Public Safety
- News
- HAM Radio
- Marine
- Railroad
- Air
- CB Radio
- FRS/GMRS/MURS
- Racing
- FM Broadcast
- Special

Press [E / yes / gps] to exit from Menu Mode and start searching the selected band.

(See: *Service Search*)

Edit Service

Select Service Search Range and press [E / yes / gps] to go to each Search Range Setting.

You can set the following items for each Service Search Range.

- Set Delay Time
- Set Attenuator
- Search with Scan

Press [E / yes / gps] to enter each setting.

Note: The first line in the display shows the name of the selected Service Search.

Set Delay Time

This setting controls how long the scanner stays on frequencies after a transmission ends before resuming searching.

Turn [Scroll Control] to select the delay time setting from the following list:

- 10 sec
- 5 sec
- 2 sec
- 0 sec
- 1 sec
- 2 sec
- 5 sec
- 10 sec
- 30 sec

Then press [E / yes / gps] to accept and return to the previous menu.

Set Attenuator

You can select to attenuate RF reception on all frequencies in the search range.

- On The frequencies are attenuated.
- Off The frequencies are not attenuated.

Press [E / yes / gps] to accept the entry and return to the previous menu.

Search with Scan

You can set the following items.

- Set Quick Key
- Set Startup Key
- Set Number Tag
- Set Lockout
- Set Hold Time

Press [E / yes / gps] to enter each setting.

Set Quick Key

You can select a Quick Key from 0 to 99 or “.” (= Not assigned) by turning [Scroll Control].

Quick Key for search is used to rapidly enable or disable the range. The searching order does not change by this setting.

Press [E / yes / gps] to accept and return to the previous menu.

Set Startup Key

The scanner locks or unlocks the search according to setting of this option by pressing and holding a number key at power-on or while displaying the Opening Screen.

Turn [Scroll Control] to select the Startup Key in this menu. The Startup Key can be set from “0” to “9” and “.” (= Not assigned).

Press [E / yes / gps] to accept the selection and return to the previous menu.

Set Number Tag

A Number Tag can be set in this menu.

Press a number key to input the number tag. Press [./no/pri] to clear the input.

Press [E/yes/gps] to accept the setting and return to the previous menu.

Note: The valid setting range is from 0 to 999. Blank means a number tag not assigned.

Set Lockout

This option allows you to lock or unlock the current search. When the search is locked out, the scanner does not check it.

Unlocked	The search is unlocked.
Temporary L/O	The search is temporarily locked out.
Lockout	The search is locked out.

Press [E/yes/gps] to accept the selection and return to the previous menu.

Set Hold Time

This setting determines the maximum time the scanner is forced to hold and search this range before moving to the next, even if there is no traffic on the frequencies.

You can change the hold time from 0 (the scanner checks all frequencies of the range regardless of time) to 255 seconds by using number keys.

If the setting is something other than "0", the scanner goes to the next system or search when the hold time elapses. However, it does not go to next one while receiving a signal.

Press [E/yes/gps] to accept the entry and return to the previous menu.

If you enter over "255" for the Hold Time, the scanner prompts "Out of Range" and "Set Max? (Y/N)". When [E/yes/gps] is pushed, maximum value 255 will be set.

It returns to the edit state, if you press [./no/pri].

Custom Search

The scanner exits from Menu Mode and goes to Search Mode. Then it starts searching the Custom Ranges. (See: Custom Search)

Edit Custom

You can edit the 10 Custom Search Ranges.

Names of Custom Search Ranges are displayed as Menu items.

For example, if all names are not changed from default name, selectable items are as follows:

Custom 1
Custom 2
:
Custom 10

Select the Name and press [E / yes / gps] to go to Menu of editing Custom settings.

Custom Settings

You can edit the follow settings.

Edit Name
Edit Srch Limit
Set Delay Time
Set Modulation
Set Attenuator
Set Step
Set C-Ch Only
Search with Scan

Press [E / yes / gps] to enter each item.

Note: The first line displays the name of the selected Custom Search.

Edit Name

You can name the custom range.

Refer to *FONT DATA* for the characters that *can be entered*.

Press [E / yes / gps] to accept the name entered. The scanner returns to the previous menu.

Edit Srch Limit

You need to set 2 limits for searching.

First, enter the lower limit frequency and store it by pressing [E / yes / gps].

Next, enter the upper limit frequency and press [E / yes / gps] to store the upper limit

The scanner returns to the previous menu.

Note: If the entered Lower Limit is higher than the entered Upper Limit, the scanner will swap these automatically.

Set Delay Time

This setting controls how long the scanner stays on frequencies after a transmission ends before resuming searching.

Turn [Scroll Control] to select the delay time setting from the following list:

- 10 sec
- 5 sec
- 2 sec
- 0 sec
- 1 sec
- 2 sec
- 5 sec
- 10 sec
- 30 sec

Then press [E / yes / gps] to accept and return to the previous menu.

Set Modulation

You can select the modulation from the following settings.

- Auto The scanner uses the modulation normal for the frequency's band. (See: [Band Defaults](#))
- AM The scanner uses AM demodulation.
- NFM The scanner uses Narrowband FM demodulation.
- FM The scanner uses FM demodulation.
- WFM The scanner uses Wideband FM demodulation.
- FMB The scanner uses FM Broadcast demodulation.

Press [E / yes / gps] to accept the entry and return to the previous menu.

Set Attenuator

You can select to attenuate RF reception on all frequencies in the search range.

- On The frequencies are attenuated.
- Off The frequencies are not attenuated.

Press [E / yes / gps] to accept the entry and return to the previous menu.

Set Step

You can select the search step for Custom Search.

- | | |
|----------|---|
| Auto | Automatically assign the search step based on the band. |
| 5.0 kHz | 15.0 kHz |
| 6.25kHz | 20.0 kHz |
| 7.5 kHz | 25.0 kHz |
| 8.33kHz | 50.0 kHz |
| 10.0 kHz | 100.0 kHz |
| 12.5 kHz | |

Press [E / yes / gps] to accept the setting and return to the previous menu.

Set C-Ch Only

These options let you set whether the scanner tracks talk group activity when it detects a Motorola or LTR control channel. This section has the following menus:

- C-Ch Only Mode
- Set MOT BandPlan

C-Ch Only Mode

You can select how the scanner tracks Motorola System and LTR System. (C-Ch means Control Channel.)

- On The scanner only searches for Motorola and LTR Control Channels.
- Off The scanner treats all signals as normal transmission.

Press [E / yes / gps] to accept the entry and return to the previous menu.

Set MOT BandPlan

You can select one of the following options to assign a band plan that the scanner will use if it detects a Motorola control channel. Note that if the actual received channel does not use the specified band plan, the scanner will not follow voice traffic on the system.

The instructions for doing this are the same as for setting a band plan for a programmed system. See *Edit Band Plan* for option settings.

Search with Scan

This menu is same as the one in the Edit Service Menu.

See *Search with Scan*.

Search and Store

This function lets the scanner search for new frequencies in Custom Search Ranges or Service Search Ranges, or new TGID's on a trunked System.

First, select a System to store the found Channels into. The scanner displays all created Systems. Turn [Scroll Control] to select the System. Press [E / yes / gps] to make the selection.

If there are no Systems, you cannot perform this function. The scanner sounds an Error Tone and displays "No System Stored". Press any key to return to the previous menu.

Note: In this function, the scanner ignores the setting of Repeater Find.

For Conventional System

If a conventional System is selected, the scanner prompts you for "Custom Search" and Service Search ranges. Turn [Scroll Control] to select the kind of search to use.

- Custom Search
- Public Safety
- News
- HAM Radio
- Marine
- Railroad
- Air
- CB Radio
- FRS/GMRS/MURS
- Racing
- FM Broadcast
- Special

Once a search range is selected by pressing [E / yes / gps], any time a frequency in that search range goes active, the scanner checks to see if that frequency has been previously stored in that System. If so, it resumes searching. Otherwise, it stores the frequency into the Group named "Found Channels" (the scanner automatically creates this group if it does not exist). Then it resumes searching.

Note: If all frequencies of the selected search are locked out, the scanner displays "All Locked!" on Second line and it cannot start storing operation. Then it goes to End State. (See: [End Conditions](#))

During Search and Store for a conventional System, "SEARCH AND STORE" scrolls on the second line.

"System Name" and "Search Range Name" are alternately displayed on first line.

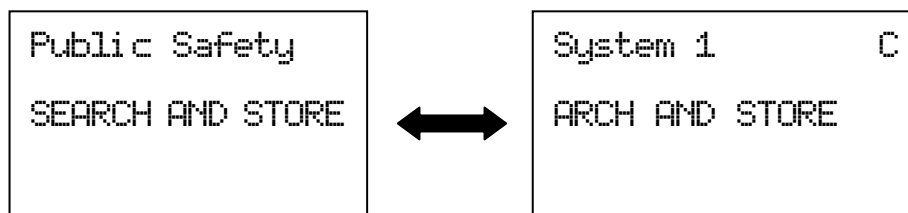

If the scanner finds a frequency, it performs duplication check in the System and displays "Memory Check" on second line. And while storing the frequency to Memory, it displays "Storing" on second line.

For Trunked System

If a trunked System is selected, you will be asked to select a site. If no site is stored in that system, message "No Site Stored Press Any Key" will be displayed and the scanner will sound an error tone. After the site is selected, the scanner begins searching that System. Any time a TalkGroup goes active, the scanner checks to see if that TalkGroup has been previously stored in that System. If so, it resumes searching. Otherwise, it stores the TGID into the Group named "Found Channels" (the scanner automatically creates this Group if it does not exist). Then it resumes searching.

If the selected site is locked out, it is unlocked and the scanner starts ID Auto Store on the site.

Note: Search and Store does not work in the following conditions. The scanner sounds an Error Tone, and it displays System Name on first Line and *Error Message* on second line. Then it goes to End State. (See: End Conditions)

Error Condition	Error Message
A System / a Site that has no frequency is selected.	"No Control Chan"
The Quick Key for the System / Site to which that System / Site belongs is turned off.	"Nothing to Scan"
The Group that stores found Channels already has the number of Max Auto Store or more Channels stored.	"Over Limit"

Note: The following selections are invalid. The scanner displays *Error Message* and "Press Any Key". Press any key to return to System selection.

Error Condition	Error Message
EDACS SCAT System is selected.	"Invalid System"
A system that does not store a site that can be selected.	"No Site Stored"

During Search and Store operation for a trunked System, "ID SEARCH AND STORE" scrolls on the second line. System / Site Name is displayed on the first Line.

```
Site 3-1      MOT
ID SEARCH AND ST
  NFM      \ /
SQ: - - - 4 - - - - -
GRP- - - / \ - - - - -
```

If the scanner finds a TGID, it performs a duplication check in the System (the scanner does not show this state). And while storing the TGID into Memory, it displays "Storing" on the second line.

End Conditions

The scanner will stop storing if the number of found frequencies or TGID exceeds Max Auto Store. Then it displays "Limit Reached" and sounds a Confirmation Tone.

When the number of Channels in trunked System exceeds 500, the scanner stops the storing operation. Then it displays "TGID Full".

When it exceeds the limit of Group/Channel creation during a storing operation, the scanner stops the storing operation. Then it displays "Over Limit" and sounds an Error Tone.

If the Memory is full, it displays "Memory Full" on the second line and sounds an Error Tone.

It does not exit from Search and Store Mode automatically.

During "Search and Store" operation or in one of the above-mentioned End State, only the following operations are valid.

Pressing [Hold / 

Pressing [Scan / srch] exits this mode and goes to Scan Mode.

Pressing [Menu] exits this mode and the scanner goes to the Menu Mode. If you exit from Menu Mode, the scanner goes to each Search Mode (selected Search for storing operation).

Pressing [FUNC] + [Menu] also exits from this mode and goes to each Menu.

Note: In this mode, you cannot hear any transmission.

Set Search Key

The scanner has three search keys that let you quickly start a search range: "Search Key 1", "Search Key 2", and "Search Key 3".

Select the number of Search Key and set a search range from the Service Search ranges, Custom Search ranges, Tone-Out and Band Scope.

Press [E / yes / gps] to accept the entry and return to the previous menu.

Close Call

This menu has the following items.

- Close Call Only
- CC Auto Store
- Hits with Scan
- Set CC Mode
- Set CC Override
- Set CC Alert
- Set CC Bands

Note: "CC" means "Close Call".

Press [E / yes / gps] to enter the menu.

Close Call Only

When this item is selected at Close Call, the scanner exits from the Menu Mode and goes to the Close Call Only Mode. Then it starts searching for Close Call hits. (See: Close Call Only, *Page 149*)

CC Auto Store

When this item is selected at Close Call, the scanner exits from the Menu Mode and goes to the CC Auto Store Mode. Then the scanner automatically stores new CC hits (up to the limit set by the Max Auto Store setting) into the Group named "Found Channels" of System named "Close Call" (automatically created if it does not exist).(See: Close Call Auto Store, *Page 150*)

Note: In this mode, you cannot hear any Close Call transmission.

Hits with Scan

These are the settings for the Close Call temporary stored system.

The setting items are as follows.

- Set Quick Key
- Set Number Tag
- Set Lockout
- Set Hold Time

Press [E / yes / gps] to enter the menu.

Set Quick Key

You can select a Quick Key from 0 to 99 or "." (= Not assigned) by turning [Scroll Control]. The Quick Key is only for rapidly enabling or disabling the system and is not for deciding the scan priority.

Press [E / yes / gps] to accept and return to the previous menu.

Set Number Tag

Number Tag can be set in this menu.

Press a number key to input the number tag. Press [.] / no / pri] to clear the input.

Press [E / yes / gps] to accept the setting and return to the previous menu.

Note: The valid setting range is from 0 to 999. Blank means a number tag not assigned.

Set Lockout

This option allows you to lock or unlock the Close Call system. When the system is locked out, the scanner does not check it.

Unlocked	The system is unlocked.
Temporary L/O	The system is temporarily locked out.
Lockout	The system is locked out.

Press [E / yes / gps] to accept the selection and return to the previous menu.

Set Hold Time

This setting determines the maximum time the scanner is forced to hold and search this range before moving to the next scanning, even if there is no traffic on the frequencies. You can change it from 0 (the scanner checks all frequencies of the range regardless of time) to 255 seconds by using the number keys.

If you choose a setting other than "0", the scanner goes to next system or search when the hold time elapses. However, it does not go to the next one while receiving a signal.

Press [E / yes / gps] to accept the entry and return to the previous menu.

If you enter over "255" for the Hold Time, the scanner prompts "Out of Range" and "Set Max? (Y/N)". When [E / yes / gps] is pushed, maximum value 255 will be set.

It returns to the edit state, if you press [.] / no / pri].

Set CC Mode

These settings affect when CC actually operates. When it is set to "CC DND" or "CC Pri" with another mode, every 2 seconds the scanner will switch the filter settings to the ones set by the CC Bands option.

Off	Close Call is turned off for all modes.
CC DND	Close Call does not function while monitoring a transmission.
CC Pri	Close Call functions every 2 seconds even if there is a carrier.

Press [E / yes / gps] to set the mode and return to the previous menu.

Note: The Close Call function is not performed in Weather Mode and Tone-Out Mode.

Set CC Override

This mode determines how the scanner will behave when a Close Call signal is detected.

- On The scanner alerts (depending on the CC Alert setting) and displays "CC Found!" then immediately jumps to the Close Call frequency.
- Off The scanner alerts (depending on the CC Alert setting) and displays "CC Found!" and "Press FUNC Key" for the time set at Set CC Pause. If you press [FUNC] or [E / yes / gps] during this time, the scanner jumps to the Close Call frequency.

Detail of this setting : Close Call Search.

Press [E / yes / gps] to accept the entry and return to the previous menu.

Set CC Alert

You can edit these settings.

- Set Alert Tone
- Set Alert Light
- Set CC Pause

Press [E / yes / gps] to enter each item.

Set Alert Tone

This item can select the type and the level alert.

- Off Beep doesn't sound.
- Alert1-9 The scanner sounds Alert1-9 with CC found.

If you select Off, the scanner returns to the previous menu.

If you select Alert1-9, the scanner goes to Alert Level selection.

- Auto The alert is set to the same volume as normal audio.
- Level1-15 The alert is fixed to the selected audio level.

Press [E / yes / gps] to accept the entry and return to the previous menu.

Set Alert Light

You can set whether the scanner should have an alert light when it gets a Close Call hit.

Alert Light Pattern selections.

- Off The alert light will not turn on
- On The alert light is set to on
- Slow Blink The alert light blinks slowly
- Fast Blink The alert light blinks fast

Press [E / yes / gps] to accept the entry and return to the previous menu.

Set CC Pause

This option can set time from the reception of a Close Call hit to when it returns to previous mode.

Turn [Scroll Control] to set from the following item.

- 3 sec
- 5 sec
- 10 sec
- 15 sec
- 30 sec
- 45 sec
- 60 sec
- Infinite

Press [E / yes / gps] to accept the entry and return to the previous menu.

Set CC Bands

This setting controls the band filtering used during Close Call operation.

You can turn on or off the following bands.

VHF Low 1	:	On/Off	:	25.0000	- 53.9800 MHz
VHF Low 2	:	On/Off	:	54.0000	- 107.9000 MHz
Air Band	:	On/Off	:	108.0000	- 136.9916 MHz
VHF High	:	On/Off	:	137.0000	- 224.9800 MHz
UHF	:	On/Off	:	400.0000	- 512.0000 MHz
800MHz+	:	On/Off	:	806.0000	- 823.9875 MHz
				849.0125	- 868.9875 MHz
				894.0125	- 960.0000 MHz
				1240.0000	- 1300.0000 MHz

Turn [Scroll Control] to move the cursor, and press [E / yes / gps] to change the setting.

- On The scanner check Close Call in this Band.
- Off The scanner does not check this Band.

Press [Menu] to return to the previous menu.

Priority Scan

You can set following items in this menu.

- Set Priority
- Set Interval
- MaxCHs/Pri-Scan

Press [E / yes / gps] to enter each setting.

Set Priority

This setting controls how the scanner treats Priority Channels.

You can select the following items.

- Off The scanner provides no special treatment for Priority Channels.
- On The scanner scans all unlocked Channels and also checks Priority Channels.
- Plus On The scanner scans only Priority Channels.

Press [E / yes / gps] to set the Priority function and return to the previous menu.

Set Interval

This menu, lets you set the priority scan active interval time.

Press the number keys to enter the time, press [. / no / pri] to clear the input.

Note: Valid input range is from 1 to 10 sec.

If you enter “0” sec for the interval time, the scanner prompts “Out of Range” and “Set Min?(Y/N)”. Press [E / yes / gps] to select the minimum value (1 sec). Press [. / no / pri] to return to the editing state.

If you enter over “10” sec for the interval time, the scanner prompts “Out of Range” and “Set Max?(Y/N)”. Press [E / yes / gps] to select the maximum value (10 sec). Press [. / no / pri] to return to the editing state.

MaxCHs/Pri-Scan

You can set the Maximum priority channel numbers that are scanned during one priority scan interrupt using this menu. If there are more scannable priority channels than the value you select, the channels are divided into more than one group and the scanner scans each group in turn.

Note: The valid set range is from 1 to 100 channels.

Press the number keys to input the number. Press [E / yes / gps] to store the setting.

If you enter “0” for the max priority scan channels, the scanner prompts “Out of Range” and “Set Min?(Y/N)”. Press [E / yes / gps] to select the minimum value (1 channel). Press [. / no / pri] to return to the editing state.

If you enters over “100” for the max priority scan channels, the scanner prompts “Out of Range” and “Set Max?(Y/N)”. Press [E / yes / gps] to select the maximum value (100 channels). Press [. / no / pri] to return to the editing state.

WX Operation

This menu lets you set the following items.

- Weather Scan
- Weather Alert
- Program SAME
- Set Delay Time
- Set Attenuator
- WX Alt Priority

Select "Weather Scan" and press [E / yes / gps] to start Weather Scan.

Select any other and press [E / yes / gps] to enter each setting.

Weather Scan

When this item is selected at WX Operation, the scanner exits from the Menu Mode and goes to Weather Scan Mode. Then it starts scanning the 10 Weather channels normally.

The scanner stops if there is a carrier. If the carrier is lost, it resumes scanning (See: WEATHER SCAN MODE)

Weather Alert

You can select how Weather Scan works. Select from "Alert Only", names of SAME groups and "All FIPS". If the names of the SAME groups are not changed from default setting, the displayed items are as follows.

- Alert Only
- SAME 1
- SAME 2
- SAME 3
- SAME 4
- SAME 5
- All FIPS

If you select Alert Only, the scanner immediately sounds a Weather Alert Siren (for Weather Alert Tone) when it detects the 1050 Hz Weather Alert Tone, then opens squelch and remains on the Weather Channel.

If you select one of the SAME Groups, the scanner attempts to decode the SAME data packets that precede the Weather Alert Tone. Then the scanner sounds a Weather Alert Siren (for Warning, Watch or Advisory) when the received County is the same as the programmed data. It then opens squelch and remains on the Weather Channel.

If you select All FIPS, the scanner sounds a Weather Alert Siren (for Warning, Watch or Advisory) when it decodes the SAME data packets. Then opens squelch and remains on the Weather Channel.

Press [E / yes / gps] to select and the scanner exits from Menu Mode. Then it goes to Weather Scan Mode with this selection.

Program SAME

You can edit the 5 SAME Groups. The names of SAME Groups are displayed as Menu Items. Default names as follows.

SAME 1
SAME 2
SAME 3
SAME 4
SAME 5

Select the Name and press [E / yes / gps] to go to Same Group Editing Menu.

SAME Group Settings

You can set the following items.

Edit Name
Edit County

Press [E / yes / gps] to go to each setting.

Note: The first line displays the name of the SAME Group.

Edit Name

You can name the SAME Group.

Refer to *FONT DATA* for the characters that *can be entered*.

Press [E / yes / gps] to accept the name entered. The scanner returns to the previous menu.

Edit County

Each SAME Group has 8 entries. You can edit the desired FIPS Code. Stored codes are displayed as Menu Items.

For example, if the SAME Group has "043221", "043227" and "-----", selectable items are as follows:

No.1 : 043221
No.2 : 043227
No.3 : -----
:
No.8 : -----

Select the item and press [E / yes / gps] to enter the editing state.

In the editing state, the editing cursor is displayed. Press the number keys to enter the FIPS code. The cursor moves to the right by entering number. Turn [Scroll Control] to choose the cursor position from the left end to next to right end character, or from left end to right end character when there are already entered up to limit of length. Press the decimal key to clear all numbers.

Press [E / yes / gps] to store the code and return to the previous menu.

Note: If you try to store the County before entering all 6 digits, that County is set to "-----" as blank.

Set Delay Time

This setting controls how long the scanner stays on the Weather Channel after a transmission ends before resuming.

Turn [Scroll Control] to select the delay time setting from the following list:

- 10 sec
- 5 sec
- 2 sec
- 0 sec
- 1 sec
- 2 sec
- 5 sec
- 10 sec
- 30 sec

Then press [E / yes / gps] to accept and return to the previous menu.

Set Attenuator

You can attenuate RF reception on the frequency.

- On The frequency will be attenuated.
- Off The frequency will not be attenuated.

Press [E / yes / gps] to accept the selection and return to the previous menu.

WX Alt Priority

This setting determines how the scanner treats the Weather Channels in Scan/Hold Mode Search/Hold Mode and Close Call Mode.

- On The scanner checks the Weather Channels every 5 seconds to check for the presence of a 1050 Hz Weather Alert Tone.
- Off The scanner does not check the Weather Channels.

Press [E / yes / gps] to set this setting and return to the previous menu.

Tone-Out for ...

This menu lets you set the following items.

- Tone-Out Standby
- Tone-Out Setup

Select “Tone-Out Standby” to start monitoring the Tone-out Frequency.

Select “Tone-Out Setup” to go to *Tone-Out Setup*.

Tone-Out Standby

When this item is selected at *Tone-Out for ...*, the scanner exits from Menu Mode and goes to Tone-Out standby Mode.

Tone-Out Setup

You can edit the 10 Tone-Out channels.

The Names of the Tone-Out channels are displayed as Menu Items.

Default names as follows.

- Tone-Out 1
- Tone-Out 2
- Tone-Out 3
- :
- Tone-Out 10

Select the Name and press [E / yes / gps] to go to *Tone-Out Settings*.

Tone-Out Settings

You can edit these settings.

- Edit Name
- Set Frequency
- Set Tone
- Set Delay Time
- Set Alert

Press [E / yes / gps] to go to each setting.

Note: The first line displays the name of selected Tone-Out channel.

Edit Name

You can name the Tone-Out channel.

Refer to *FONT DATA* for the characters that *can be entered*.

Press [E / yes / gps] to accept the name entered. The scanner returns to the previous menu.

Set Frequency

You can set the following items.

- Edit Frequency
- Set Modulation
- Set Attenuator

Press [E / yes / gps] to go to each setting.

Edit Frequency

If you select to edit the frequency, the scanner displays the current frequency in edit mode.

Press the number keys and [. / no / pri] to enter the frequency.

Press [E / yes / gps] to return to the previous menu.

Set Modulation

You can select the modulation from following settings.

- Auto* The scanner uses the modulation normal for the frequency's band.
- NFM The scanner uses Narrowband FM demodulation.
- FM The scanner uses FM demodulation.

Press [E / yes / gps] to accept the entry and return to the previous menu.

Set Attenuator

You can attenuate RF reception on the frequency.

- On The frequency will be attenuated.
- Off The frequency will not be attenuated.

Press [E / yes / gps] to accept the selection and return to the previous menu.

Set Tone

You can set the following items.

- Edit Tone A
- Edit Tone B

Press [E / yes / gps] to go to each setting.

Edit Tone

When you select "Edit Tone A" or "Edit Tone B", you can set the frequency for Tone A or B from 250 to 3500 Hz, and 0Hz.

Press [E / yes / gps] to set the Tone frequency and it remains on Tone A / B selection.

Set Delay Time

This setting controls how long the scanner stays on Mute Off state after a transmission ends.

Turn [Scroll Control] to select setting value from:

- 0 sec
- 1 sec
- 2 sec
- 5 sec
- 10 sec
- 30 sec
- Infinite

Then press [E / yes / gps] to accept and return to the previous menu.

Set Alert

You can set these options in this menu.

- Set Alert Tone
- Set Alert Light

Press [E / yes / gps] to enter the setting.

Set Alert Tone

You can set whether the scanner should sound an Alert Tone when a tone-out channel becomes active*.

- | | |
|-----------|--|
| Off | No alert sounds. |
| Alert 1-9 | The scanner sounds Alert1-9 with the Channel becomes active. |

If you select "Off", the scanner returns to the previous menu.

If you select "Alert1-9", the scanner goes to Alert Level selection.

- | | |
|-----------|--|
| Auto | The alert is set to the same volume as normal audio. |
| Level1-15 | The alert is fixed to the selected audio level. |

Press [E / yes / gps] to accept the entry and return to the previous menu.

Set Alert Light

You can select whether the scanner should have alert light when a tone-out Channel becomes active*.

Alert Light Pattern selections.

Off	The alert light will not turn on
On	The alert light is set to on
Slow Blink	The alert light blinks slowly
Fast Blink	The alert light blinks fast

Press [E / yes / gps] to accept the entry and return to the previous menu.

*"Active" means that the scanner detects Tones and Mute state is set to Off.

Wired Clone

Connect two BC346XTs and select this menu to copy and override all data from one to another.

Master
Slave

The scanner you set to Master's data will be copied to the scanner you set to Slave. Then go to Wired Clone Mode. (See: WIRED CLONE MODE)

Settings

You can set the following items from this menu.

- Set Backlight
- Adjust Key Beep
- Battery Option
- Adjust Contrast
- Set C-CH Output
- Set GPS Format
- Set Serial Port
- Band Defaults
- See Scanner Info

Press [E / yes / gps] to enter each setting.

Set Backlight

This menu has the following items.

- Set Mode
- Set Dimmer

Press [E / yes / gps] to enter each setting.

Set Mode

This option can be used to set the backlight activation mode.

You can select from the following options.

- 10 sec
- 30 sec
- Squelch
- Keypress
- Infinite

Press [E / yes / gps] to accept the data and return to the previous menu.

Set Dimmer

This option can be used to set the brightness level of the display.

You can select from the following options.

- High
- Middle
- Low

Press [E / yes / gps] to accept the data and return to the previous menu.

Adjust Key Beep

Adjusts the beep tone volume level.

Auto	Key Beep is set to the same volume as normal audio.
Level 1–15	Key Beep is fixed to the selected volume level.
Off	Key beep is Off.

Press [E / yes / gps] to set the Beep volume level and return to the previous menu.

Battery Option

This menu has the following items.

Set Battery Save
Set Charge Time

Press [E / yes / gps] to enter each setting.

Set Battery Save

This option can be used to set the battery save feature.

On	Set battery save on
Off	Set battery save off

Press [E / yes / gps] to accept the selection and return to the previous menu.

Set Charge Time

This option can be used to set the battery charge time.

Press the number keys to enter the charge time from 1 to 16 hours.

Press [E / yes / gps] to accept the data and return to the previous menu.

Adjust Contrast

This function sets the contrast of the display from "Contrast 1" to "Contrast 15".

Press [E / yes / gps] to accept the selection and return to the previous menu.

Set C-CH Output

The scanner can output the data stream on control channel by using this function.

Off	data stream is not outputted
On	data stream is outputted
Extend	data stream and description are outputted

Press [E / yes / gps] to accept the data and return to the previous menu.

(See *Control Channel Data Stream Output* for detail)

If the baud rate is slow, the scanner cannot output all data streams. Therefore it is recommended you use a baud rate of 115200 bps.

Set GPS Format

You can set the following items for GPS.

- Set Pos Format
- Set Time Format
- Set Time Zone
- Set Unit

Press [E / yes / gps] to go to each setting menu.

Set Pos Format

The option sets the position format for latitude and longitude.

- DMS:DDD⁰MM'SS.ss
- DEG:DDD.dddddd

Note: This setting changes all Location Input displays and the GPS Mode display.

Press [E / yes / gps] to accept the selection and return to the previous menu.

Set Time Format

This option sets the time format.

- 12H The scanner uses 12-hour format.
- 24H The scanner uses 24-hour format.

Press [E / yes / gps] to accept the data and return to the previous menu.

Set Time Zone

This option sets the time zone and daylight savings time.

You can set an offset value from GMT from “-14.0 H” to “+14.0 H” in 0.5H increments.

Press [E / yes / gps] to accept the selection and return to the previous menu.

Set Unit

This option selects the unit that will be active for location range, elevation and speed of the GPS feature.

- mile
- km

Note: This selection also changes the unit used for location range and speed.

Press [E / yes / gps] to accept the selection and return to the previous menu.

Set Serial Port

You can set the serial port speed from the following items.

- 4800 bps
- 9600 bps
- 19200 bps
- 38400 bps
- 57600 bps
- 115200 bps
- Off

Press [E / yes / gps] to accept the selection and return to the previous menu.

Band Defaults

This menu lets you set the default modulation and default step for each band.

The band settings are shown as menu items.

- 25.0:AM / 5.0
- 26.9:AM / 5.0
- 27.4:AM / 5.0
- 28.0:NFM/ 20.0
- 29.7:NFM/ 10.0
- 50.0:NFM/ 20.0
- 54.0:WFM/ 50.0
- 72.0:FM / 5.0
- 76.0:WFM/ 50.0
- 88.0:FMB/100.0
- 108.0:AM / 8.3
- 137.0:NFM/ 12.5
- 144.0:NFM/ 5.0
- 148.0:NFM/ 12.5
- 150.8:NFM/ 5.0
- 162.0:NFM/ 12.5
- 174.0:WFM/ 50.0
- 216.0:NFM/ 20.0
- 400.0:NFM/ 12.5
- 406.0:NFM/ 12.5
- 420.0:NFM/ 12.5
- 450.0:NFM/ 12.5
- 470.0:NFM/ 12.5
- 806.0:NFM/ 12.5
- 849.0:NFM/ 12.5
- 894.0:NFM/ 12.5
- 1240.0:NFM/ 25.0

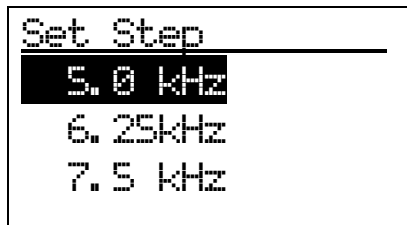
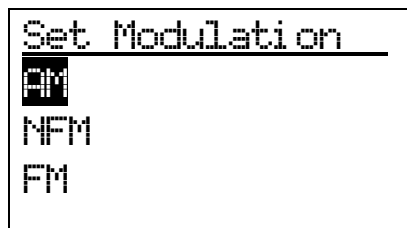
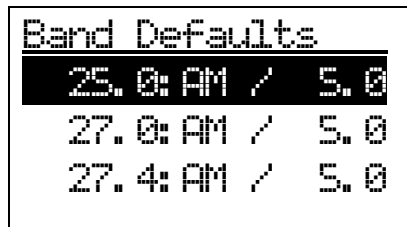

Turn [Scroll Control] to focus the cursor on the band you want to change. Then, press [E / yes / gps] to enter the modulation setting menu.

The following modulation setting values will be shown.

- AM set the current band as AM modulation
- NFM set the current band as NFM modulation
- FM set the current band as FM modulation
- WFM set the current band as WFM modulation
- FMB set the current band as FMB modulation

Turn [Scroll Control] to select the value, press [E / yes / gps] to set the selection and go to the Step Setting menu.

Selectable step values are:

- 5.0 kHz
- 6.25kHz
- 7.5kHz
- 8.33kHz
- 10.0 kHz
- 12.5 kHz
- 15.0 kHz
- 20.0 kHz
- 25.0 kHz
- 50.0 kHz
- 100.0 kHz

Turn [Scroll Control] to select the value, press [E / yes / gps] to set the selection and return to the Band Defaults setting menu.

See Scanner Info

This menu lets you see some information about the scanner, including the memory usage.

Select from the following items.

- % Memory Used
- Firmware Version

Press [E / yes / gps] to go to each setting.

% Memory Used

When you select this option, the scanner displays the percent of memory that is used, the number and percent of systems, sites and channels that are created.

This display is as follows.

Memory Used:	62%
SYSTEM 135:	27%
SITE 921:	92%
CHN 15758:	63%

The Value is displayed until you press any key and return to the previous menu.

Firmware Version

When you select this option, the scanner displays the firmware version as "Version #.#.#.#".

And the serial number of the unit is displayed as "SN#####"

Note : The serial number includes 14 digits.

Press any key to return to the previous menu.

SCAN MODE

Display during Scan Mode

The LCD display in Scan mode is as follows.

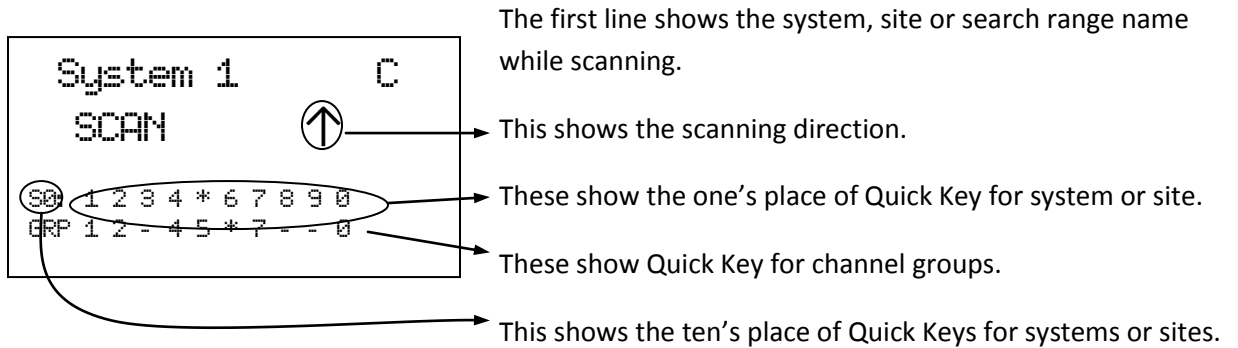

- SCAN : This scrolls to the left from the right while Scan Mode.
- S : This icon appears with icons of Quick Key numbers for Systems / Sites.
- GRP : This icon appears with icons of Quick Key number for Groups.

Startup Key Operation

The scanner can change the lockout state for each system or each site when you turn it on while pressing a number key.

First, you set the Startup Key for each system or each site.

You can set one key from 0 to 9 for each system or site.

If you hold a number key while turning on the scanner, it displays the following message after displaying the copyright message.

```
Startup Config.  
Key No. 1  
Processing  
Please Wait
```

Systems and Sites whose Startup Key matches the one you press are unlocked and systems and sites whose Startup Key do not match are locked out. Systems and Sites whose startup key are assigned "." are not affected (if they were locked or unlocked before, their lockout status does not change).

Quick keys for the matching systems and sites are also enabled.

Start Scanning

When you press [Scan / srch] to go to the Scan Mode the scanner scans all sites and systems that are not locked out and whose System/Site quick key is enabled. Then, the scanner scans all unlocked Service and Custom Search Ranges whose quick keys are enabled (Search with Scan). After Search with Scan, the scanner scans CC Hits System.

While in the Scan Mode, the first line displays currently scanned system, site or search range name and the second line displays "SCAN" (for conventional System) or "ID SCAN", "ID SEARCH" (for trunked System) scrolling from the right to the left, or a search frequency. Disabled Quick Keys are displayed as "*". The Quick Key for the Current System blinks.

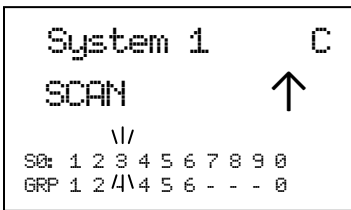

Scan for conventional system

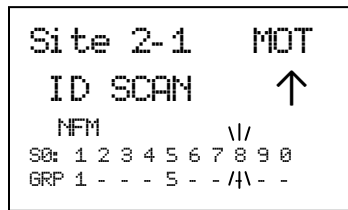

ID Scan for trunked system

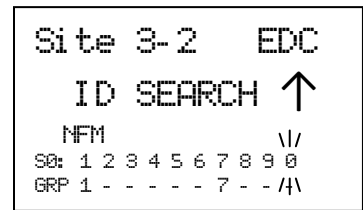

ID Search for trunked system

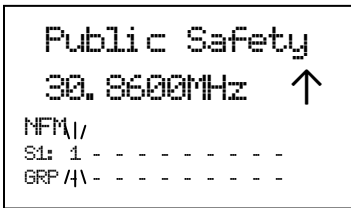

Service Search in Search with Scan

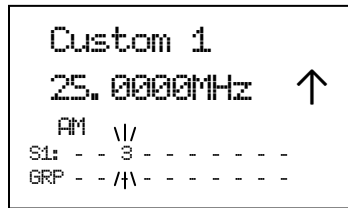

Custom Search in Search with Scan

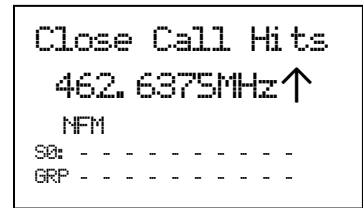

Close Call Hits with Scan

When all channels are locked out directly or indirectly*, the scanner displays "Nothing to Scan" and the scanner stays in the Scan Mode.

*"A channel is locked out directly or indirectly" means:

1. The channel is locked out.
2. The group containing the Channel is locked out.
3. The Quick Key for groups to which that group belongs is disabled.
4. The system / site containing the channel is locked out.
5. The Quick Key for systems / sites to which that system belongs is disabled.

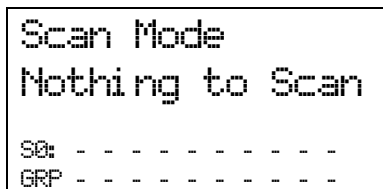

If the Channels are unlocked by cancellation of any of the above-mentioned states, the scanner will start scanning immediately.

Scanning Order

First, systems belonging to Quick Key 1 are scanned. Then systems that belong to Quick Key 2, ..., 9, 0, 11, ..., 19, 10, 21, ..., 99, 90 are scanned in order. Systems with no Quick Key are scanned last.

When the scanning of all systems ends, the scanner starts Service Search for any unlocked/enabled searches. The scanner searches Public Safety, News, . . . , and Special in turn.

When Service Search ends, it starts Custom Search. The scanner searches Custom Search from range 1 to 10 in turn.

After Custom Search ends, the scanner scans a system that is named "Close Call Hits*"

*This is a system where the scanner automatically stores the frequencies found by Close Call.

(See *CC Hit with Scan* for details.)

If "Close Call Hits" system has no frequencies, the scanner does not scan this system. After the scanner finishes scanning "Close Call Hits" system, the scanner scans from top system again.

You can change the scanning direction by turning [Scroll Control].

The scanning order of the systems / sites belonging to the same Quick Key is the order registered to that Quick Key. The scanning order of the systems / sites belonging to no Quick Key is the order set to none.

When a system / site is created, the scanner automatically sets the Quick Key to none. So, if you do not change the Quick Key setting, the scanning order will be the order of system / site creation.

The scanning order of groups in a conventional system also depends in the order set to any Group Quick Key or none. Groups with no Group Quick Key set are scanned in the order of group creation.

The scanning order of Channels in a conventional system's channel group depends in the order of Channel creation.

However, locked out or disabled items* are not scanned.

*Locked out or disabled items means locked out System / Sites, locked out Channel Groups, locked out Channels, disabled System/Site Quick Keys and disabled Group Quick Keys.

Scanning Operation

Quick Key Operation

For Conventional Systems, the SQK is set at the system level. However, for trunked systems, the SQK is set at the site level instead of the system level.

In the display, enabled SQKs show their number; disabled SQKs show "*"; SQKs with no system assigned show "-".

During scanning, you can enable or disable single digit SQKs by pressing the corresponding [1 - 9, 0] key.

For two-digit SQK's first press [./no/pri], then enter the two digits to enable or disable that SQK.

Systems belonging to disabled SQKs are not scanned.

*You cannot enable or disable an SQK if no system or site is assigned to it.

*The displayed GQKs (channel Group Quick Keys) show the status of GQKs for the system currently being scanned.

For example, the scanner displays as follows if the SQKs "3", "4", "6", and "9" are disabled.

```
System 1      C
SCAN         ↑
SQ: 1 2 * * 5 * 7 8 * 0
GRP 1 2 3 4 5 6 7 8 9 0
```

The details of scanning depend on whether the System is a conventional System or a trunked System.

The SQK's Ten's blinks when you press [./no/pri] (until you enter the SQK's first digit).

```
System 1      C
SCAN         ↑
SQ: 1 2 * * 5 * 7 8 * 0
GRP 1 2 3 4 5 6 7 8 9 0
```

If you do not press a digit within 2 seconds of pressing [./no/pri], the entry times out and nothing is changed.

Scan for Conventional Systems

In conventional scanning, the scanner steps through each unlocked channel. If there is activity on the channel, the scanner monitors activity until the transmission ends.

While monitoring the transmission, the first line alternates between the current system name and current group name every 1 second. The second line displays the current channel name.

The Quick Keys for the current system and channel group blink. Furthermore, the attenuation setting, modulation and CTCSS/DCS data of the current channel are displayed.

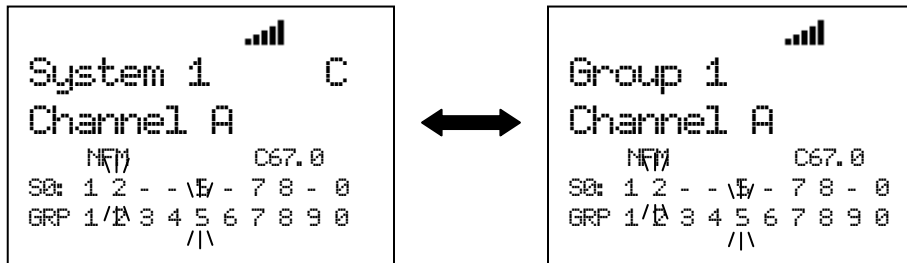

Even if the transmission ends, the scanner holds on the channel for the duration of the system delay time. After the system delay time elapses, if there is no transmission the scanner resumes scanning.

*If CTCSS/DCS is applied to a channel, the received signal must match for the scanner to hold on the transmission. (Not for AM, WFM or FMB modulation.)

The scanner continuously scans each system for the duration of the system's system hold time setting. However, the scanner scans all unlocked channels at least 1 time, even if this takes longer than the set time.

The scanner will advance to the next system once the scanner scans all unlocked channels and the system hold time has elapsed.

Scan for Trunked Systems

In trunked scanning, the scanner holds on the control channel (C-Ch) and decodes the TGIDs as they become active.

*If C-Ch Only is set to on at Set C-Ch Only for the site, trunking is performed using control channel data only. A voice channel (V-Ch) does not have to be programmed into memory. (Motorola Systems only)

While scanning, press Function then [Scan / srch] to toggle between ID Scan and ID Search. You can also change this mode through the Menu. (See: ID Scan/Search.)

ID Search :

If a TGID does not match any locked out TGID, the scanner goes to the V-Ch and monitors the transmission until it ends.

ID Scan :

If a TGID matches a TGID stored in an unlocked channel, the scanner goes to the V-Ch and monitors the transmission until it ends.

While monitoring a TGID already stored into the Memory, the first line of the display alternates between the current site name and current channel group name every 1 second, and second line displays the current channel name. The Quick Key numbers for the current site and group blinks.

While monitoring a TGID not stored into the Memory, the first line displays current site name, and the second line displays the current TGID. The current Site and Group Quick Keys blink.

While monitoring the TGID:

Press [Scan / srch] or turn [Scroll Control] to return to the C-Ch. Then the scanner waits for a moment on the C-Ch to see if another TGID is active. If the scanner finds another TGID, it monitors the found TGID. But if there is only the TGID that was being monitored just before, it monitors that TGID again.

Press [L/O] to lock out the TGID and store it to the list of ID Lockouts of the system (See: Clr All L/O IDs). This lock out information is common to every site in the system. Then the scanner returns to the C-Ch.

If the transmission ends, it returns to the C-Ch and exclusively listens for the last-active TGID until the site delay time expires.

After the system delay time elapses, the scanner checks to see if the Site Hold time has elapsed. If so, the scanner advances to the next System or Site. If the Site Hold Time has not elapsed, the scanner continues to monitor the C-Ch for TGID activity.

Lockout Operation

You can lock out each site but cannot lock out the system to which the site belongs.

In Trunked Systems (except EDACS SCAT system), one system can have multiple sites and those sites share the same TalkGroup IDs.

If you lock out a TGID, the TGID is locked out for all sites in the system.

ID Display Format

The scanner displays received ID in the following format on the second line.

Normal ID

The scanner displays as "ID:xxxx" for no-named TGID.

Example)	MOT Type I ID	:	ID:101-1	
	MOT Type II	:	ID:12345	(Decimal Format)
		:	ID:123 h	(Hexadecimal Format)
	EDACS	:	ID:01-023	(AFS Format)
		:	ID:147	(Decimal Format)
	LTR	:	ID:0-20-254	

I-Call

The scanner displays ID as "ID:xxxxxx" for no-named TGID. In order to show that ID is I-Call, "i" is displayed on the left end of the ID.

Example)	MOT Type I I-Call	:	ID:i12345	
	MOT Type II	:	ID:i12345	(Decimal Format)
		:	ID:i1234h	(Hexadecimal Format)
	EDACS I-Call	:	ID:i12345	

I-Call wild card (i0)

The scanner will display the received I-Call for wild card.

Example)	I-Call wild card	:	ID:i0	(while scanning)
			ID:i123456	(when it receives a ID)

MOT Individual Call

The scanner displays both IDs under communication as "ID:xxxxxx-yyyyyy".

In order to show that IDs are Individual Call, "i" is displayed on the left end of IDs.

Example)

MOT Type I Individual Call	:	ID:i12345-i23456	
MOT Type II	:	ID:i12345-i23456	(Decimal Format)
	:	ID:i1234h-i2345h	(Hexadecimal Format)

*If the left side ID is already named, the scanner only displays that ID's name.

PATCH ID

The scanner displays a PATCH list IDs and received PATCH ID as "ID:xx-xxx yy-yyy".

(xx-xxx : One of the PATCH list IDs, yy-yyy: received PATCH ID)

Example)	EDACS PATCH ID:	ID:01-012 00-002
	MOT Type II:	ID:42000 42016

*If the first PATCH list ID is already named, the scanner only displays that ID's name.

PARTIAL ID

The scanner displays the wild card portion of a PARTIAL ID as "-" in ID scanning.

When the scanner finds the ID that matches the PARTIAL ID, it displays the full received ID.

Example)	PARTIAL ID:	ID:01-01-	(while scanning)
		ID:01-015	(when it receives a ID)

Quick Save for ID Search

Press [E / yes / gps] to quickly store a TGID when the scanner stops on the TGID in ID Search.

The scanner prompts "Quick TGID Save?".

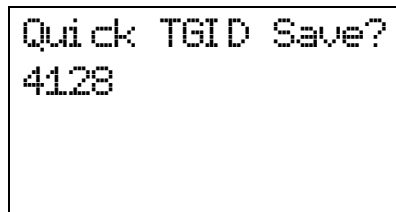

Quick TGID Save?
4128

Press [E / yes / gps] to store the TGID. The scanner creates a channel group named "Qck Save Grp" in the current system. The TalkGroup ID is stored in that channel group.

If you want to select another channel group to stores the TGID, press [./ no / pri]. Then select the group to store the channel into. The scanner stores it in the selected channel group.

Trunking Activity Indicators (Display Mode 3)

The scanner shows trunking activity when held on the C-Ch.

Press [6 / RIGHT / disp] in Function Mode to change the Display Mode in Scan Hold Mode. (See SCAN HOLD MODE.)

In EDACS and LTR systems, the order of indicators is the order of LCN.

In Motorola systems, it is the order of the frequency programming.

*This mode does not work for EDACS SCAT Systems. Only the C-CH blinks in Motorola Systems you've programmed using C-CH Only Mode.

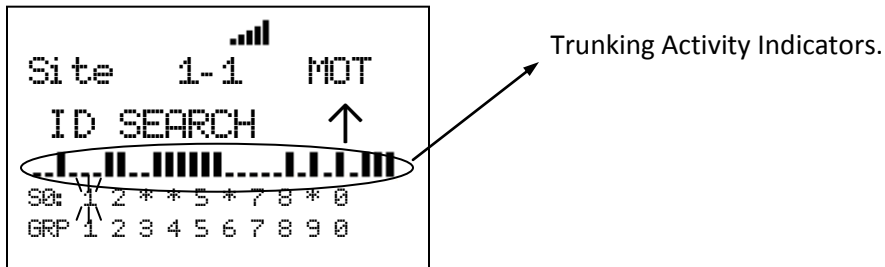

When the scanner receives a trunked system channel grant, the V-Ch blinks and the C-Ch lights. The scanner has 30 Channel Activity Indicators to visualize trunked system activity. This shows which site frequencies are in use.

The following figure shows that the scanner is staying on LCN1 and LCN3 and LCN4 are active.

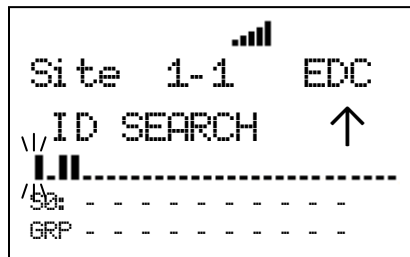

While the scanner is staying on a V-Ch, the voice channel blinks and its C-Ch turns on.

The following figure shows that the scanner is staying LCN3 and LCN1 is the control channel.

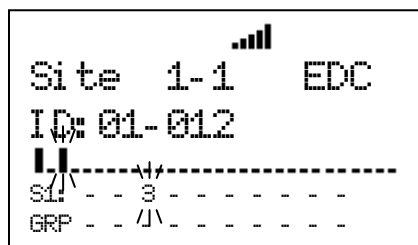

Location Based Scanning

This operation controls the lockout state for each group or site when the scanner is connected to a GPS unit.

This works automatically based on the location data from GPS when the feature is set to "On" in Set GPS Enable.

If the scanner goes within the location's range for a group or site, the scanner displays "Location Unlock" on the first line and the group name or the site name on second line.

```
GPS
Location Unlock
Site 1-1 MOT
SQ: - - - - -
GRP - - - - -
```

When the scanner goes outside the set range, the group or site is automatically temporarily locked out.

The scanner displays "Location L/O" on first line and the group name or the site name on second line.

```
GPS
Location L/O
Site 1-1 MOT
SQ: - - - - -
GRP - - - - -
```

This operation does not affect systems/sites whose SQK is disabled.

If a GPS is detected as soon as the scanner is turned on, the scanner displays "GPS CONNECTED" instead of displaying individual lock/unlock messages for groups and sites. It applies the location-based rules to all systems at one time.

```
GPS
GPS CONNECTED
SQ: - - - - -
GRP - - - - -
```

Control Channel Data Stream Output

The scanner can output the data stream on the control channel. You can turn on this feature in the menu Set C-CH Output. When it is active, the scanner will output the data stream whenever it is receiving a control channel. Also, for Motorola analog systems, the scanner will output the low speed data stream while receiving a voice channel.

Data Stream Output: ON

When data stream output is set to on, the scanner will output the data stream in the following format:
<Msg Type>,<CC data>.

Data Stream Output: Extend

When data stream output function is set to extend, the scanner will output the data stream in the following format: <Msg Type>,<CC data>,<decoded description>.

<Msg Type>=

ASCII character (3 chars):

MOT (Motorola)

EDW (EDACS Wide)

EDN (EDACS Narrow)

LTR

<CC data> =

OSW Data on Control Channel. It is deferent each Trunk System Type.

[MOT System]

MOT,<cmd>,<prv>,<id>

<cmd> = command or LCN (Hex 3 digits, 10 bits)

<prv> = private bit (1 bit)

<id> = ID (Hex 4 digit, 16 bits)

For example:

MOT,15C,0,D110

[ED Wide/Narrow]

EDW,,<cc>,<pppppp>

 = block number in a OSW (0 or 1)

<cc> = command (Hex 2 digits, 6 bits)

<pppppp> = message (Hex 6 digits, 22 bits)

For example:

EDW,0,3B,238333

EDN,0,3B,238333

Note: For EDACS narrow systems, the indicator will change from EDW to EDN.

[LTR System]

LTR,<A>-<GG>-<HH>-<III>-<FF>

<A> = Area Number (0 or 1)

<GG> = Goto Repeater Number (Hex 2 digits, 5 bits)

<HH> = Home Repeater Number (Hex 2 digits, 5 bits)

<III> = ID Number (Hex 2 digits, 8 bits)

<FF> = Free Repeater Number (Hex 2 digits, 5 bits)

For example:

LTR,0-01-01-FA-02

[MOT Subaudio]

MOT,<id>

<id> = ID (Hex 4 digit, 16 bits)

For example:

MOT,D110

<decoded description>

For Motorola system:

Decoded Description	Remark
,CNM TG-tttt CH-ccc VC-ffffff	Call for Talk Group tttt = Talk Group ID (Hex 4 digits, 16 bits) ccc = LCN (Hex 3 digits, 10 bits) ffffff = Frequency (BCD 8 digits)
,CIP TG-tttt CH-ccc VC-ffffff	Call for ICALL tttt = Talk Group ID (Hex 4 digits, 16 bits) ccc = LCN (Hex 3 digits, 10 bits) ffffff = Frequency (BCD 8 digits)
,CIV TG-tttt TGR-dddd CH-ccc VC-ffffff	Call for ICALL (Individual Call) tttt = Talk Group ID (Hex 4 digits, 16 bits) dddd = Talk Group ID for Receiver (Hex 4 digits, 16 bits) ccc = LCN (Hex 3 digits, 10 bits) ffffff = Frequency (BCD 8 digits)
,CPT TG-tttt CH-ccc VC-ffffff	Call for Patch/Multiselect tttt = Talk Group ID (Hex 4 digits, 16 bits) ccc = LCN (Hex 3 digits, 10 bits) ffffff = Frequency (BCD 8 digits)
,EVM	Event Command for Multiple OSW
,SID-ssss	System ID ssss = System ID (Hex 4 digits)
,PAT-pppp MEM-mmmm	Patch List Update pppp = Patch/Multiselect ID (Hex 4 digits, 16 bits) mmmm = Member ID (Hex 4 digits)
,SIT-nn	Site Number nn = Site Number (Hex 2 digits, 6 bits)
,CCH CH-ccc CC-ffffff	Control Channel ccc = LCN (Hex 3 digits, 10 bits) ffffff = Frequency (BCD 8 digits)

For EDACS system:

Decoded Description	Remark
,CNM TG-ttt CH-cc VC-ffffff	Call for Talk Group ttt = Talk Group ID (Hex 3 digits, 11 bits) cc = LCN (Hex 2 digits, 5 bits) ffffff = frequency (BCD 8 digits)
,CIP TG-tttt CH-cc VC-ffffff	Call for ICALL tttt = Unit ID (Hex 4 digits, 14 bits) cc = LCN (Hex 2 digits, 5 bits) ffffff = frequency (BCD 8 digits)
,CPT TG-ttt CH-cc VC-ffffff	Call for Patch tttt = Patch ID (Hex 3 digits, 11 bits) cc = LCN (Hex 2 digits, 5 bits) ffffff = frequency (BCD 8 digits)
,PAT-ppp MEM-mmm	Patch List Update ppp = Patch ID (Hex 3 digits, 11 bits) mmm = Member ID (Hex 3 digits, 11 bits)
,SIT-ss	Site ID ss = Site ID (Hex 2 digits, 6 bits)

For LTR system:

Decoded Description	Remark
,CAL TG-a-hh-dd Free-ee CH-gg VC-ffffff	Call for Talk Group a = Area (Hex 1 digits, 1 bit) hh = Home Ch (Hex 2 digits, 5 bits) dd = ID (Hex 2 digits, 8 bits) ee = Free Ch (Hex 2 digits, 5 bits) gg = Goto Ch (Hex 2 digits, 5 bits) ffffff = Frequency (BCD 8 digits)
,DIS TG-a-hh-dd Free-ee	Disconnect Code a = Area (Hex 1 digits, 1 bit) hh = Home Ch (Hex 2 digits, 5 bits) dd = ID (Hex 2 digits, 8 bits) ee = Free Ch (Hex 2 digits, 5 bits)

Temporary System Hold

*For trunked systems, “system” should be read as “site” in this section.

**In Temporary System Hold state, Priority Scan and Close Call function are not performed.

The scanner scans only one system while displaying **F** icon by pressing [FUNC] Key. This state is called "Temporary System Hold".

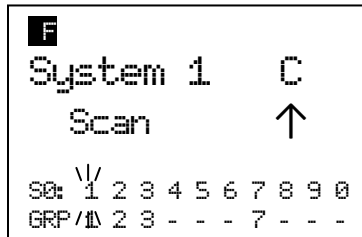

In this state, press [L/O] once to temporarily lock out a current system with “Temporary L/O” message.

Press [L/O] twice within one second to permanently lock out the current system with “Locked out” message.

Long press this key to display the prompt “Unlock All Systems?” for unlocking all systems, sites, search ranges and Close Call Hits system and enable all Quick Keys for all system/site.

Press [E / yes / gps] to unlock all data. Then scanner displays “All Systems” and “Unlocked”.

Press [. / no / pri] to return to the previous mode without unlocking.

In a trunked system, press [Scan / srch] key in Function Mode to change ID Search and ID Scan for the system.

When you select a system while the scanner is Temporary System Hold without a timeout, the scanner scans only the selected system.

If the selected system is locked out, it is automatically unlocks and scans the system. Other lockout states* are not unlocked.

When it cannot scan the selected system, the scanner displays the system name on the first line and “Nothing to Scan” on the second line.

The scanner displays this message until you press any key. Then the scanner exits Temporary System Hold Mode and starts scanning.

**“Other lockout states” means the following. The scanner displays “Nothing to Scan”.

- Quick Key for the selected system is disabled.
- All channel groups for the selected system are locked out.
- Quick key for all channel groups are disabled off.
- All channels for the selected system are locked out.

System Hold

Long press [Hold / 

While on System Hold, the scanner scans only one system and the scanner flashes the HOLD icon.

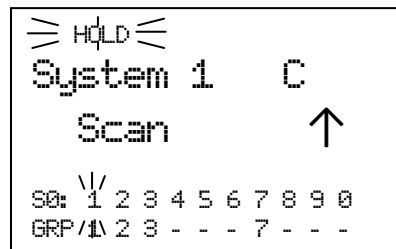

Long press [Hold / 

If the selected system can't be scanned, the scanner can't go to System Hold Mode.

Quick System Select

*In trunked system, the "system" means "site" for this section.

*In Quick System Select state, Priority Scan and Close Call function are not performed.

Turn [Scroll Control] knob in Function Mode to select a System. While selecting systems, scanning is not performed.

You can select from all Systems that have 1 or more Channels. Locked out Systems and Systems belonging to disabled SQKs also appears in this selection.

Press [E / yes / gps] or the [Scroll Control] to select a system and return to the previous mode.

Press [L/O] in Function Mode to toggle lockout state for the selected system.

Press [1 - 9, 0] in Function Mode to enable or disable GQKs for the selected System.

Quick System Select Resume

Pressing [FUNC] or [E / yes / gps] or pressing the [Scroll Control] resumes scanning immediately from the selected system even if the system is locked out (it is force to be unlocked). The scanner also resumes scanning when a timeout happens.

The temporary system hold status continues after system selection.

If the scanner has no channels to scan (as listed below) in the selected system, it displays "Nothing to Scan".

- SQK for the selected system is disabled.
- All channel groups for the selected system are locked out.
- GQK for all channel groups are disabled.
- All channels for the selected system are locked out.

The scanner resumes scanning from the next system when you press any key.

System Select in Scan Hold Mode

When you go to Quick Select System from Scan Hold Mode and exit from this state, the scanner holds on the first channel of the selected system.

If you select a locked out system, the locked state for the selected system is not changed.

Quick Save for CTCSS/DCS Data

When CTCSS/DCS search is set for a conventional channel and the scanner is detecting a CTCSS/DCS tone data, you can store the tone data into the current channel by pressing [E / yes / gps]. The scanner prompts "Set Found CTCSS/DCS?" and "Yes="E" / No=".".".

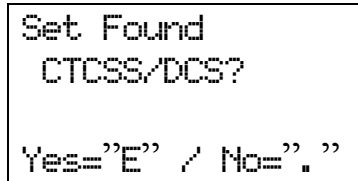

```
Set Found
CTCSS/DCS?

Yes="E" / No="."
```

Press [E / yes / gps] to store the tone data and go to the editing menu for the current channel.

Press [. / no / pri] to go to the editing menu for the current channel without storing it.

Press [Scan / srch] or [Hold / 

Press [L/O] or [MENU] to cancel the prompt and returns to the previous mode.

Key Operation During Scan

Normal Mode

[Scroll Control] knob

Turn this knob to resume scanning while monitoring.

Turn this knob to change the scan direction. If the scanner is scanning system scan, service search, then custom search turn this knob counterclockwise to scan custom search, service search, then system scan.

[Scan / srch] key

Press this key to resume scanning while monitoring.

[Hold /] key

Press this key to go to Scan Hold Mode.

Long press this key for System Hold Mode.

In System Hold Mode, long press this key for full system scan.

[L/O] key

Press this key once to temporarily lock out the monitored channel or TGID (in ID Search Mode). When the scanner is turned off, the channel or TGID is unlocked.

Press this key twice within one second to lockout the monitored channel or TGID (in ID Search Mode). When the scanner is turned off, these lockouts remain.

Long press this key to unlock all channels and TGIDs in the current system when the scanner is receiving a signal.

[1 - 9, 0] key

Press these keys to enable or disable SQKs.

[. / no / pri] key

Press this key to go to the mode that selects the ten's place for SQKs, then press the number key to jump to the ten's place.

[E / yes / gps] key

Press this key to edit the data for the current channel.

If the current system is a protected system, the scanner displays the "Protected System Access Not Allowed Press Any Key" and sound an error tone.

[MENU] key

Press this key to go to the Menu Mode at Top Menu.

Function Mode

F+[Scroll Control] knob

Turn this knob to select a system quickly. The scanner will start scanning from the selected system.

F+[Scan / srch] key

If the current system is a conventional system or search range:

- Press this key to display the prompt for starting Quick Search.
- Press [E / yes / gps] to start Quick Search.
- Press [. / no / pri] to go to Search for...
- Press [L/O] to cancel the prompt.
- Press [Hold / 

If the current system is a trunked system:

- Press this key to switch between ID Search and ID Scan.

F+[Hold /

Press this key to toggle Close Call functions.

Long press this key to start Close Call Only Mode.

F+[L/O] key

Press this key once to temporarily lock out a system, site, or a search range. When the scanner is turned off, this is unlocked.

Press this key twice in a second to lockout a system, site or a search range. When the scanner is turned off, these lockouts remain.

Long press this key to display the prompt “Unlock All Systems?” to unlock all systems, sites, search ranges and Close Call Hits system and enable all Quick Keys for all systems/sites.

Press [E / yes / gps] to unlock all data.

Press [. / no / pri] to return to the previous mode without unlocking.

F+[1 - 9, 0] key

Press this key to enable or disable GQKs for the current system.

F+[. / no / pri] key

Press this key to toggle Priority Mode for conventional priority.

F+[E / yes / gps] key

Press this key to change to the GPS Mode.

Long press this key to store the current location. Then the scanner prompts you to select the location type.

F+[MENU] key

Press this key to go to the editing menu for the current system or current search range.

If the current system is a protected system, the scanner displays the “Protected System Access Not Allowed Press Any Key” and sounds an error tone.

SCAN HOLD MODE



Press [Hold / 

Display while in Scan Hold Mode

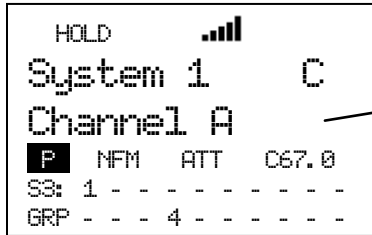
The display in Scan Hold mode is as follows.



This shows a channel name or a frequency.

C67.0	:	This appears when the channel has a CTCSS or DCS. In CTCSS/DCS Search Mode, if this is hit, the value blinks. If CTCSS/DCS is set to lockout, the display alternates between the CTCSS/DCS data and "*****".
HOLD	:	This icon appears while in Scan Hold Mode.
	:	This icon shows the strength of the signal from 0 to 5.
	:	This icon appears if the channel is set to "Priority On".
NFM	:	These icons show the modulation type.
ATT	:	This icon appears when the channel is set to "Attenuator On".
SQ:	:	This icon appears with icons of the SQK (from "0" to "99"). x shows the current ten's place for the SQK.
GRP	:	This icon appears with icons of the GQK (1 - 9,0).

General Operation

Turn [Scroll Control] to select the channel, trunk frequency, TGID or search frequency.

Hold on a Channel in Conventional System:

The scanner alternately displays the system and channel group name on the first line and it displays the channel on the second line. The SQK and GQK for the channel is displayed. The scanner continuously monitors the selected channel.

While holding on a channel, the scanner changes the display for the system name and channel group name every second.

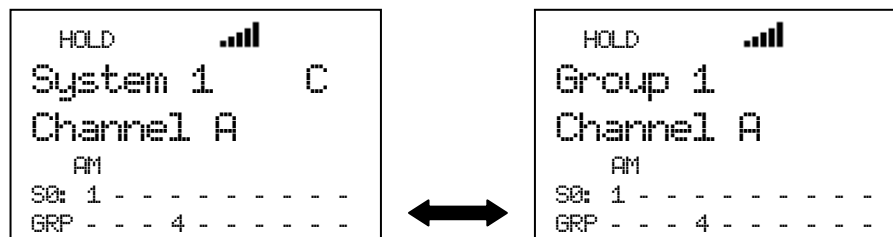

Press [E / yes / gps] to go to the editing menu of channel you are holding on at Channel Settings.

Press [FUNC] to go to the Function Mode and display the system number tag, channel number tag, IF Exchange and Volume level.

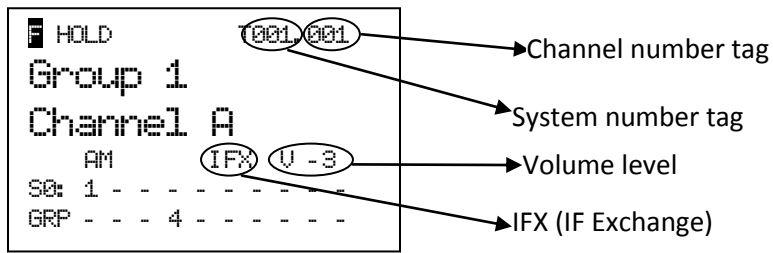

Press [6 / RIGHT / disp] in Function Mode to change the Display Mode.

The scanner displays the channel name on the second line.

In Display Mode 2, the scanner displays the current channel frequency under the channel name instead of the priority channel icon, modulation icon, and attenuator.

In Display Mode 3, since the scanner can't display the Trunking Activity Indicators for a conventional system, it displays just like Mode 1 for conventional.

For example, the scanner displays as follows when the channel name for "162.4000MHz" is "Channel A".

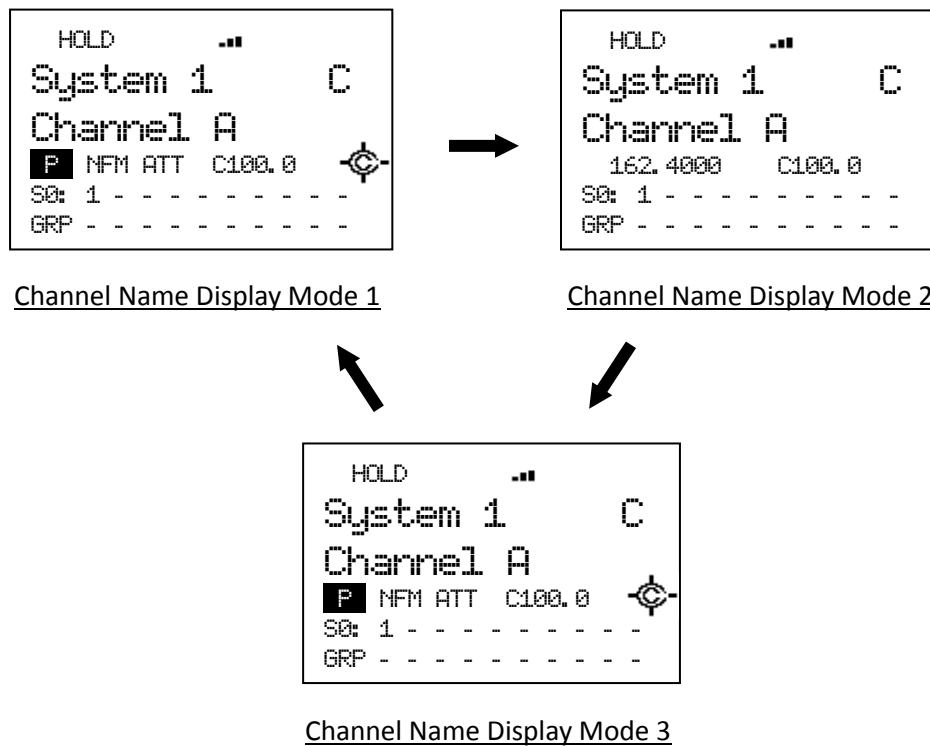

In Display Mode 2, even if the Close Call setting is "CC Pri" or "CC DND", the Close Call icon is not displayed when CTCSS/DCS setting is set or tone data has been detected in CTCSS/DCS Search mode.

Hold on a Channel (TGID) in Trunked System:

*If there are two or more sites in the system, the same TGIDs will appear in every site. The scanner checks the current site for the selected TGID.

When you hold on a channel in a trunked system and a C-Ch exists, the scanner displays as follows.

If the TGID you are holding on is stored into the system, first line alternately displays the site name and channel group name. The second line displays the TGID Name. The V-Ch frequency is displayed under the TGID display.

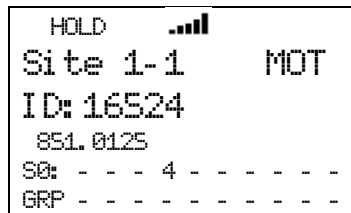

Press [6 / RIGHT / disp] in Function Mode to change the Display Mode.

In Display Mode 1, the scanner displays the TGID name on the second line and the V-Ch frequency under the second line.

In Display mode 2, the scanner displays the TGID name on the second line and TGID under the second line.

In Display mode 3, the scanner displays the TGID name on the second line and trunking activity indicators under the second line.

For example, the V-ch frequency is “851.0250MHz” and the channel name of “ID:16512” is "Police".

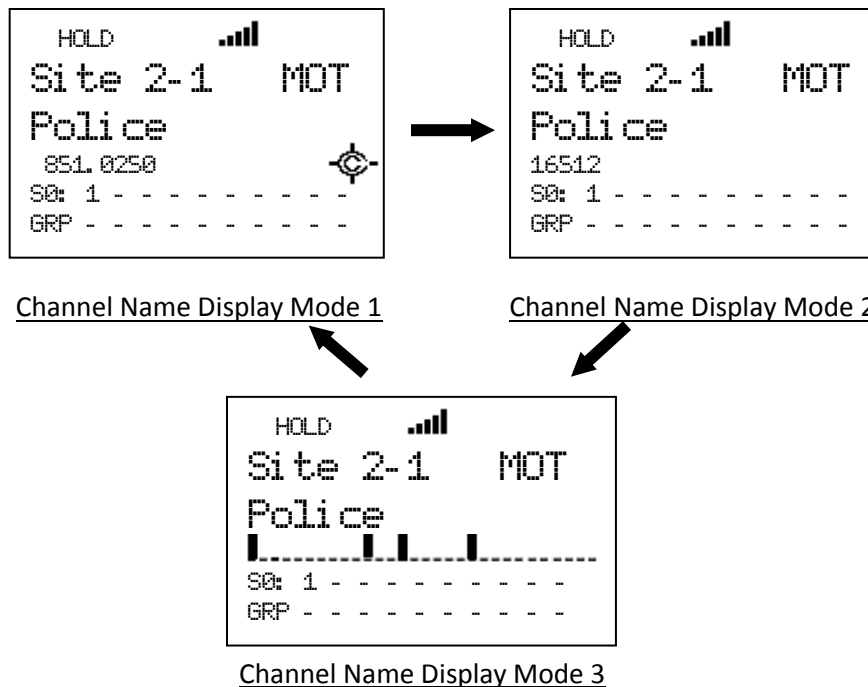

In Channel Name Display Mode 2 and 3, even if the Close Call setting is “CC Pri” or “CC DND”, the Close Call icon is not displayed.

For example, "ID:0-01-063" for the LTR System displays in Channel Name Display Mode 2.

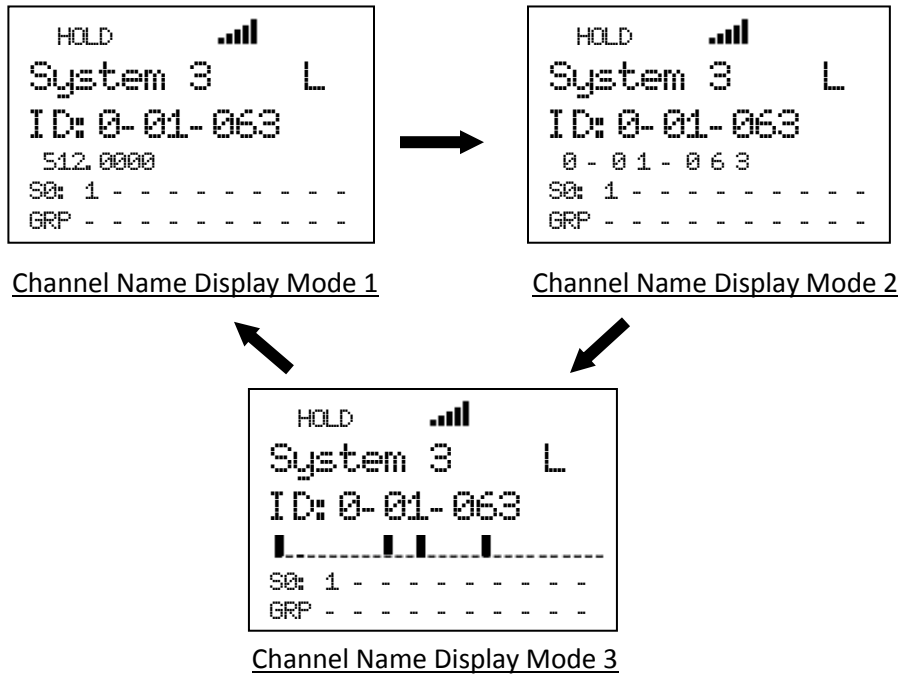

Hold on System Frequency:

The scanner displays the system name and System ID on the first line. It displays the trunk frequency on the second line.

For example, if 935.0125 MHz in "Site 3-1 MOT" belonging to Quick Key 1 is selected, the scanner displays:

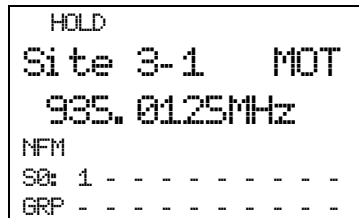

Press [E / yes / gps] to go to the System Editing menu at System Settings.

When the scanner receives a TGID, it displays the received TGID on the second line. If the TGID is already stored into the system and it is named, the channel name is displayed instead of the TGID. The holding trunked frequency is displayed under the TGID display.

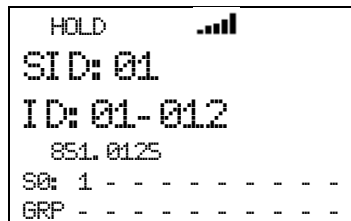

*In Motorola System, System ID is displayed as "SID:xxxxh-yyzz".

"xxxxh" means System ID. "yy" means Sub System ID. This is always is 00 for Motorola analog systems. "zz" means SITE ID.

For a system other than an EDACS SCAT System, the scanner monitors the received signal on the C-Ch or V-Ch.

*For EDACS SCAT Systems, the scanner only monitors Voice Data. It always displays system name on the first line and the trunk frequency on the second line.

Hold on Search Frequency:

The scanner displays the Search Range Name on the first line and the held frequency on the second line.



Press [E / yes / gps] to go to Quick Save Mode.

Hold on Conventional System

Turn [Scroll Control] clockwise to select the next channel.

Turn [Scroll Control] counterclockwise to select the previous channel.

If you turn [Scroll Control] clockwise when the scanner is on the last channel in the system, the scanner goes to the next system. If you turn [Scroll Control] counterclockwise when the scanner is on the first channel in the system, it goes to the previous system.

Hold on Trunked System

Turn [Scroll Control] to select the site frequency and channel (TGID).

Turn [Scroll Control] clockwise to select the next system frequency or channel and turn [Scroll Control] counterclockwise to select previous one.

If you turn [Scroll Control] clockwise when the scanner is on the last site frequency, it goes to the first channel in the System. If you turn [Scroll Control] clockwise when the scanner is on the last channel, it goes to the next system or site.

Turning [Scroll Control] counterclockwise on the first channel goes to the last site frequency. And turning [Scroll Control] counterclockwise on the first site frequency goes to the previous system or site.

When the scanner holds on a site frequency, the scanner displays the received TGID. It does not go to any voice channel. And you cannot lock out the displayed TGID.

Hold on TalkGroup ID from ID Search / ID Scan

The scanner monitors the held TGID continuously.

While monitoring a TGID already stored into Memory, the first line displays alternates between the current site name and the current group name, and the second line displays the current channel name. Also, the SQK and GQK numbers for the current monitoring site and channel group appears.

While monitoring an TGID not stored into Memory, the first line displays the current site name and the second line displays the monitored TGID. Also the SQK number for current Site appears.

Press [Scan / srch] or [Hold / 

Direct Entry

*The scanner receives nothing in this mode.

You can quickly store a frequency or a TGID using [0 - 9] and [. / no / pri].

You can also direct access channels that have channel number tags assigned.

Store Frequency

*You cannot use this function to store a frequency for a trunked System.

To quickly store a frequency into a channel for a conventional system, enter the frequency including the decimal point using the keypad, then press [E / yes / gps]. The scanner prompts "Quick Freq Save?".

*If you press [Hold / Go to Quick Search Hold Directly)



```
Quick Freq Save?  
25.0000MHz
```

If you press [E / yes / gps], the scanner creates a system named "Qck Save Cnv Sys" and creates a group named "Qck Save Grp" in the System. The scanner stores the entered frequency. If the scanner already the system and the group, the frequency is stored into the group.

If you press [. / no / pri], you can select a conventional system and the channel group for the frequency. The scanner displays only conventional systems that already exists. Next, the scanner displays channel groups and lets you select the channel group to store the entered frequency into.

Store TGID

To quickly store a TGID into a channel, enter the TGID using the number and decimal keys. Press the decimal key twice to enter a hyphen. If you press the decimal key first or at the left end, it will be entered as "i" for I-Call ID. Then press [E / yes / gps] and the scanner prompts "Quick TGID Save?".



```
Quick TGID Save?  
4128
```

If you press [Hold / 

If you press [E / yes / gps], the scanner creates "Qck Save Grp" in the current system and stores this TGID there.

If you press [. / no / pri], the scanner prompts you to select a system to store this TGID.

Select the system* and the channel group, then the TGID is stored.

*In system selection, the scanner displays only the systems whose TGID format matches the TGID you entered. The ID format and system type relation are the following.

Input TGID (n: number)	System Type
nnn-nn nnnn-n n- nnn- nnnn- nnn-n nnnnn innnnn	Motorola Systems (Type I, Type II)
nn-nnn nn- nn-nn- innnnn	EDACS Systems *Only AFS Format is allowed for Direct Entry except for I-Call ID.
n-nn-nnn n-nn-	LTR Systems

*For details of TGIDs, please see: [TGID FORMAT FOR TRUNKED SYSTEM.](#)

Once saved, the scanner allows you to change the Channel settings at menu location [Channel Settings.](#) Press [HOLD / 

Direct Access

Use this feature to quickly access a channel with number tags. System or channel number tags can be set in the menu. However if you set a channel number tag that already exists in the same system, or if you set a system tag that already exists in another system (include scan systems, service search with scan systems, custom search with scan systems, CC Hits with scan systems), a warning message will be displayed “No.Tag Exists Accept? (Y/N)”. Press [E / yes / gps] to set the same number tag, or press [/ no / pri] to input a new number tag.

To jump to a tagged channel from HOLD mode, enter the system number tag followed by a decimal point then the channel’s number tag, then press [MENU]. The scanner goes to Scan Hold Mode at the entered number tag.

For example, if you want to select Channel E from the below example, press [7][.][5][Menu].

System A (Number tag = 1)	Channel A (Number tag = 1)
	Channel B (Number tag = 5)
	Channel C (Number tag = 100)

System B (Number tag = 7)	Channel D (Number tag = 10)
	Channel E (Number tag = 5)
	Channel F (Number tag = 3)

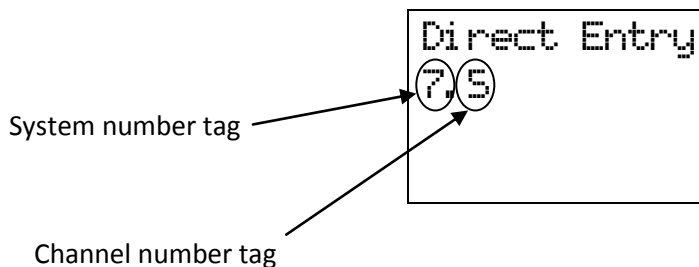

You do not have to enter the system number tag to select a channel in the current system.

When the scanner is holding on one of System A’s channels, press [1][0][0][Menu] to select Channel C.

If you press only system number tag with a dot, the scanner select the first channel of the system. Pressing [7][.][Menu], Channel D is selected. If no such system number tag exists, the scanner displays “SYS Number Tag XXX. is not Stored Press Any Key” and sounds an error tone.

If you enter an illegal channel number tag, the scanner displays “CH Number Tag XXX.XXX is not Stored Press Any Key” and sounds an error tone.

Key Operation During Scan Hold Mode

Normal Mode

[Scroll Control] knob

Turn this knob to select the channel.

[Scan / srch] key

Press this key to resume scanning.

[Hold /] key

Press this key to resume scanning.

Long press this key to activate System Hold Mode and resume scanning.

[L/O] key

Press this key once to temporarily lock out the held frequency or TGID. When the scanner is turned off, this is unlocked.

Press this key twice in a second to lock out the held frequency or TGID. When the scanner is turned off, this remains locked.

Long press this key to unlock all channels in the current system (for conventional systems).

Long press this key to unlock all frequencies of the site and all TGIDs of the current system (for trunked system / sites).

[1 - 9, 0] key

Press this key to enter numbers and go to Direct Entry.

[. / no / pri] key

Press this key to input decimal point, hyphen or “i” for Direct Entry.

[E / yes / gps] key

Press this key to edit the data for the current channel.

Press this key to edit the system when the scanner is held on a trunked frequency.

If the current system is protected system, the scanner displays “Protected System Access Not Allowed Press Any Key” and sound an error tone.

[MENU] key

Press this key to go to the Menu Mode at Top Menu.

Press this key to use Direct Access in Direct entry mode.

[FUNC] key

Press this key to go to Function Mode with a 3-second timeout. The scanner displays the system number tag and channel number tag. If you do not press a key within 3 seconds, function mode is automatically cancelled.

Long press this key to go to Function Mode without a timeout.

Function Mode



[Scroll Control] knob

Turn this knob to quickly select a system.

[Scan / srch] key

Press this key to display the prompt for starting Quick Search.

If the current system is a conventional system or search range:

- Press [E / yes / gps] to start Quick Search.
- Press [. / no / pri] to go to Search for...
- Press [L/O] to cancel this prompt.
- Press [Hold / - If the current system is a trunked system:
 - Press [E / yes / gps] to start ID Search.
 - Press [. / no / pri] to go to Search for...
 - Press [L/O] to cancel this prompt.
 - Press [Hold / 

[Hold /

Press this key to toggle Close Call functions.

Long press this key to start Close Call Only Mode.

[L/O] key

Press this key once to temporarily lock out a system or a search range. When the scanner is turned off, this is unlocked.

Press this key twice in a second to lockout a system or a search range. When the scanner is turned off, this remains locked out.

Long press this key to turn on all Quick Key settings for systems / Sites, and unlock all systems and search ranges.

Long press this key to display the prompt “Unlock All Systems?” for unlocking all systems, sites, search ranges and Close Call Hits system and enable all Quick Keys for all system/sites.

Press [E / yes / gps] to unlock all data.

Press [. / no / pri] to return to the previous mode without unlocking.

[1-3 / sr1-3] key

Press this key to start searching the search range set at Set Search Key.

[4 / LEFT / ifx] key

Press this key to exchange the IF(intermediate frequency) for receiving radio signals to avoid interference.

[5 / lvl] key

Press this key to change the volume offset level.

[6 / RIGHT / disp] key

Press this key to change the Display Mode.

(Display mode 1 -> Display mode 2 -> Display mode 3 -> Display mode 1 ->....)

[7 / att] key

Press this key to toggle the attenuator setting.

Long press this key to toggle the global attenuator setting.

[8 / rev] key

Long press this key to show the reverse frequency for the current frequency.

And release this key to return to the current frequency.

[9 / mod] key

Press this key to toggle the modulation state for global setting.

[0 / wx] key

Press this key to change WX Alert Priority Mode.

Long press this key to start WX Scan.

[. / no / pri] key

Press this key to toggle Priority Mode for conventional priority.

[E / yes / gps] key

Press this key to change to the GPS Mode.

[MENU] key

Press this key to go to the editing menu for the current system or current search range.

If the current system is a protected system, the scanner displays "Protected System Access Not Allowed Press Any Key" and sound an error tone.

PRIORITY SCAN

There are two kinds of Priority Scan. (See: [Set Priority](#))

Refer to [Set Priority](#) for setting Priority Channels.

Priority Scan

This works in Scan Mode or Scan Hold Mode when the Priority Scan setting is on. In this condition, "PRI" icon appears.

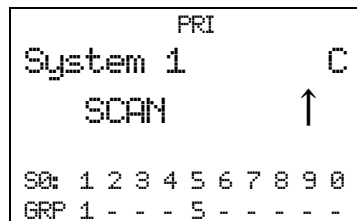

When the scanner is scanning a conventional system, it interrupts every 2 seconds to check Priority Channels (P-Ch) of all unlocked conventional Systems for activity. If there are many P-Chs, Priority Scan interrupts normal scanning for a long time.

Although any conventional frequency can be set as a priority channel, the scanner is unable to scan over 100 channels at once. If there are more than 100 unlocked priority channels, the first 100 channels will be scanned for priority scanning but others won't.

The priority for P-Channels is determined by System and Group Quick Key settings.

The highest priority is for P-Channels to which the SQK and GQK are "1". And the lowest priority is for P-Channels to which the SQK is "90" and GQK is "0".

Priority for P-Channels in the same channel group follows the order in which the channels were created.

If there are no Priority Channels or all Priority Channels are locked out, the scanner displays "Priority Scan No Channel" and sounds an Error Tone. The scanner cannot work the Priority Scan. The scanner restarts normal scanning when you press any key. Priority Scan is set to off automatically.

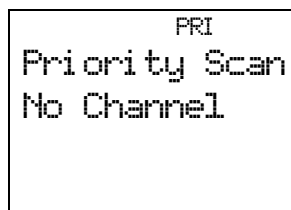

Priority Plus Scan

This works in Scan Mode or Scan Hold Mode when the setting of Priority Scan is Plus On. In this condition, the "PRI" icon blinks and the scanner scans only Priority Channels.

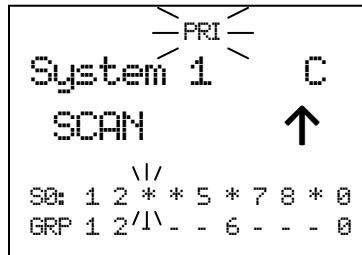

If there is no Priority Channel or all Priority Channels are locked out, the scanner displays "Priority Scan No Channel" and sounds an Error Tone. Then Priority Plus Scan stops.

Press any key to cancel it. Priority Scan is turned off automatically and it starts normal scanning.

Key Operation During Priority Scan

Key operations are the same as in Scan Mode and Scan Hold Mode.

See: [Key Operation During Scan](#) and [Key Operation During Scan Hold Mode](#).

PRIORITY ID SCAN

Refer to [Set Priority](#) to set Priority Channels. Refer to [Priority ID Scan](#) for activation of Priority ID Scan.

Priority ID Scan

Priority ID Scan works in ID Scan/Search Mode or ID Scan/Search Hold Mode when the Priority ID Scan setting is on.

This works on Motorola and EDACS (Wide, Narrow), and LTR Systems.

This function is very similar to conventional priority although there is no “interrupt” during the transmission. Priorities are checked in between transmissions, when the scanner is receiving the control channel, as during the channel delay period.

Motorola system can receive priority IDs while the scanner is on the voice channel. However, for this to work, the channel must also be assigned as a priority channel by the radio system (otherwise, the TGID will never be sent on the voice channel’s low-speed data).

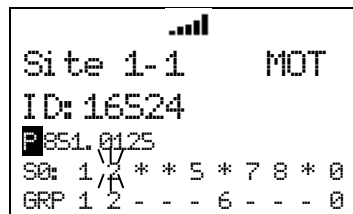

A screenshot of a scanner's LCD display. At the top right, there is a signal strength indicator (four bars) and the text 'MOT'. Below that, the display shows 'Site 1-1', 'ID: 16524', and 'P 851.0125'. At the bottom, there are two lines of alphanumeric characters: 'SQ: 1 2 * * 5 * 7 8 * 0' and 'GRP 1 2 - - - 6 - - - 0'. There are some small, faint markings on the screen, possibly from a pen or finger.

The scanner can only look for priority channels on the trunked system it is currently scanning and only responds if the priority channel is unlocked..

The within the system, channels in channel groups with GQK 1 are treated with highest priority, followed by 2, 3, ... 9, 0.

Key Operation During Priority ID Scan

Key operations are same as in ID Scan Mode and ID Scan Hold Mode.

See: [Key Operation During Scan](#) and [Key Operation During Scan Hold Mode](#).

SEARCH MODE

The scanner has Service Search, Custom Search and Quick Search in Search Mode.

Display during Search Mode

The LCD display in Search mode is as follows.

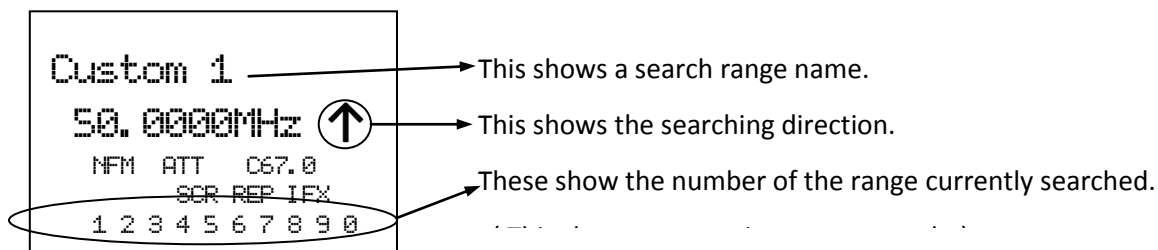

- NFM : These icons show the modulation type.
- ATT : This icon appears when the attenuator for a range or global attenuator is On.
- C67.0 : The scanner displays the data of CTCSS/DCS in the location here.
- SCR : This icon appears when one or more Broadcast Screen is set to On.
- REP : This icon appears when the Repeater Find function is On.
- IFX : This icon appears on frequency that have IF exchange On.

General Operation

While searching, frequencies are displayed in order, and the searching direction is also displayed on right end.

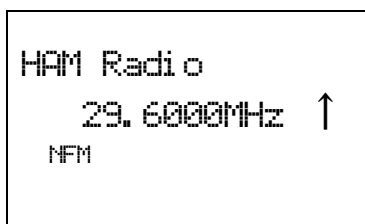

While searching, locked out frequencies are skipped. The lockout information is common to all Searches and Close Call. You can confirm or unlock these locked out frequencies at [Freq Lockouts](#).

Press [Hold / 

If CTCSS/DCS Search is On (See: [Tone/Code Search](#)), the scanner searches for any active CTCSS/DCS on the frequency. (Not for the AM, FMB and WFM modulation.)

For example, if it stops on 152.8700MHz in News and finds CTCSS is 67.0 Hz, the scanner displays as follows.

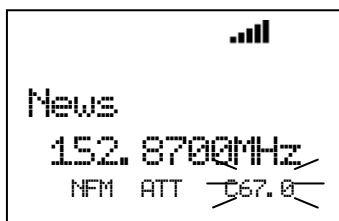

If the scanner finds DCS 023, the scanner would display “DCS023” instead of “C67.0”.

Service Search

You can search one of the pre-programmed search ranges.

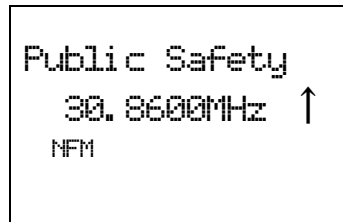

The Scanner starts from the lowest frequency of the selected range and searches in ascending or descending order. While searching, turn [Scroll Control] to change the searching direction.

If the scanner finds a transmission, it stops on the frequency and the second line displays the frequency and the unit "MHz". The scanner displays a signal meter that shows a signal level. (1 – 5)

For example, if it stops on 30.9000 MHz in Public Safety, the scanner displays as follows.



If the search range is one that includes channel numbers (like CB or Marine), the scanner displays the frequency and the channel number. The frequency unit is not displayed.

For example, if it stops on 27.4050 MHz of CB Radio, the scanner displays as follows.

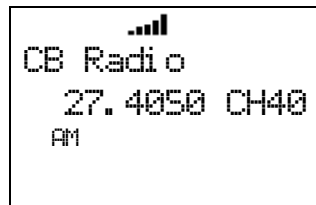

While monitoring the transmission, press [SCAN / srch] in Function Mode or turn [Scroll Control] to resume searching.

Press [L/O] once to temporarily lock out the frequency. The scanner displays "Temporary L/O".

Press [L/O] twice in a second to permanently lock out the frequency. The scanner displays "Locked Out", then resumes searching from the next frequency.

*If you lock out all frequencies in the selected range, the scanner displays "All Locked!" on the second line and searching does not work.

Custom Search

Custom search can start by selecting Custom Search.

When performing a custom search, you can turn on or off custom ranges by pressing the [0 - 9] keys. You cannot turn off the last Custom Range. If you try, the scanner sounds an Error Tone. The scanner only searches turned on custom ranges. The current search range number blinks.

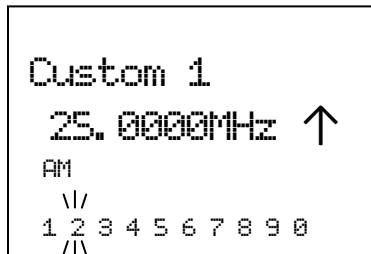

The scanner starts searching from the lowest frequency of the first turned on range and proceeds in ascending order. Or, it starts from the highest frequency of the last turned on range and searches in descending order. While searching, turn [Scroll Control] to change the search direction.

If the scanner finds a transmission, it stops on the frequency and the second line displays the frequency.

While monitoring the transmission, press [SCAN / srch] in Function Mode or turn [Scroll Control] to resume searching.

Press [L/O] once to temporarily lock out the frequency. The scanner displays "Temporary L/O".

Press [L/O] twice in a second to lock out the frequency permanently. The scanner displays "Locked Out", then resumes searching from the next frequency.

If you turn off the current search range number, the scanner searches from the next range.

The scanner stays on a frequency until the delay time expires after a transmission ends.

When you start a Custom Search by selecting "Custom Search" from the Menu, the frequency is initialized and the scanner starts searching. When searching in ascending order, the scanner searches from the lowest frequency of the lowest-numbered turned on Range. When searching in descending order, the scanner searches from highest frequency of the highest-numbered turned on Range.

When the scanner returns to Custom Search by canceling Menu Mode, it resumes searching from the previous frequency in the previous direction. However, if the limit settings of one of Custom Ranges are changed and the previous frequency becomes out of limit, it searches from the lowest frequency of the previous Range for ascending order or from highest frequency of the previous Range for descending order.

Custom Search Temporary Hold :

The scanner searches only the selected range while in Function Mode. When the scanner returns to Normal Mode, it resumes searching all enabled ranges.

Custom Search Range Select :

You can select the range by turning [Scroll Control] in Function Mode. When the scanner returns to Normal Mode, it searches from the selected range.

If you select a range that is turned off, the scanner turns on the range and starts searching from the range.

Custom Search in Control Channel Only Mode

This is valid only for Custom ranges that have the C-CH Only setting turned on at Set C-Ch Only. And this function tracks Motorola and LTR.

The scanner searches only for control channels. If a received transmission is not a control channel, searching resumes immediately.

Receive Motorola Control Channel:

The scanner starts trunking. Acquired TGIDs are displayed. The first line displays the system name and system ID name/ID in turn. The second line displays the TGID. The C-Ch frequency is displayed in the line under the TGID display.

If you have set the correct band plan for the received control channel at Set MOT BandPlan, the scanner will automatically track voice calls on the system.

The scanner toggles the following display while receiving signals.

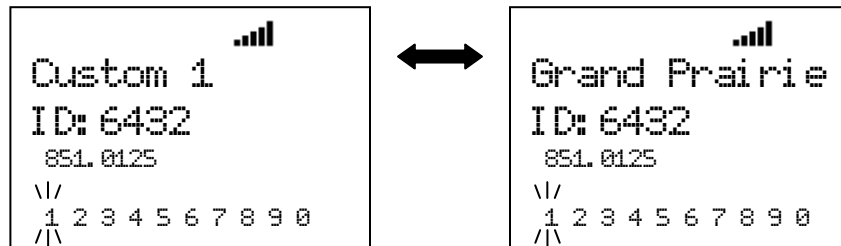

Scanner displays system name.

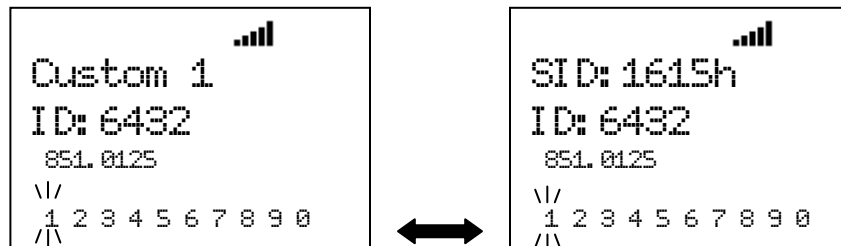

Scanner displays system ID.

If no ID exists, it displays "ID: -----".

Receive LTR Control Channel:

The scanner displays "LT System" and TGID. The scanner toggles the following display while receiving it.

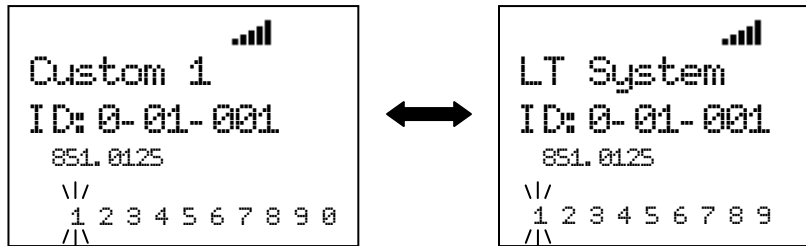

Key Operation :

Turn [Scroll Control] to resume Frequency Search.

When receiving a Motorola control channel, press [6 / RIGHT / disp] key in Function Mode to change the system ID name display (Display Mode 1,3) and system ID display (Display Mode 2). This doesn't work in Scan Mode, because this is used for Group Quick Key operation.

Search and Store

The scanner searches and stores found frequencies or TGIDs automatically. You can make the scanner perform this function by menu selection. See Search and Store for details.

In this operation, the setting of Set C-Ch Only is invalid.

Quick Search

Quick Search searches all bands.

You can start Quick Search by pressing [SCAN / srch] key in Function Mode during Scan Mode, Scan Hold Mode, Close Call Mode, Weather Scan Mode and Tone-Out Mode. The scanner prompts "Quick Search?".

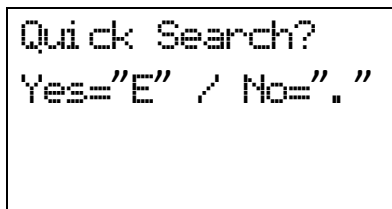

If you press [E / yes / gps], the scanner starts Quick Search.

If you press [./ no / pri], the scanner goes to the Search for... Menu at Search for...

If you press [Hold / , the scanner goes directly to Quick Search Hold Mode.

Pressing [L/O] cancels the prompt and it returns to previous mode.

Quick Search for frequency

The scanner searches from the current channel frequency when the Quick Search starts from monitoring / holding in conventional systems, Close Call Mode, Weather Scan Mode and Tone-Out Mode.

The range of this searching is all ranges of the scanner.

Turn [Scroll Control] to change the searching direction.

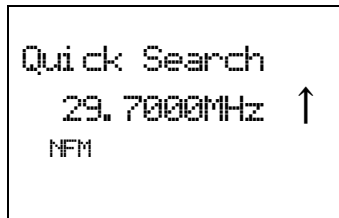

If the scanner finds a transmission, it stops on the frequency and the second line displays the frequency.

While monitoring the frequency, press [SCAN / srch] in Function Mode or turn [Scroll Control] to resume searching.

Press [L/O] once to lock out the frequency temporarily. The scanner displays "Temporary L/O".

Press [L/O] twice in a second to lock out the frequency permanently. The scanner displays "Locked Out", then resumes searching from the next frequency.

Quick Search for TalkGroup ID

When the scanner is on a trunked system in Scan Hold Mode, the scanner performs ID Search operation on the current System. The setting of ID Scan/Search is ID Search. See [Scan for Trunked Systems](#).

Key Operation During Search Mode

Normal Mode

[Scroll Control] knob

Turn this knob to change the searching direction.

While monitoring a frequency, turn this knob to resume searching.

[SCAN / srch] key

Press this key to go to Scan Mode.

[Hold /] key

Press this key to go to Search Hold Mode.

[L/O] key

Press this key to temporarily lock out the current frequency. When the scanner is turned off, the frequency is unlocked.

Press this key twice in a second to permanently lock out the current frequency. When the scanner is turned off, the frequency remains locked.

Long press this key to unlock all frequencies that are locked out in Search Mode and Close Call Mode.

[1 - 9, 0] key

Press this key to turn on or off each custom search range. However, this key operates only in Custom Search and does not operate in other searches.

[E / yes / gps] key

Press this key to quickly store the current frequency.

[MENU] key

Press this key to go to the Menu Mode at Top Menu.

Function Mode

[Scroll Control] knob

Turn this knob to select a custom search range. The scanner restarts searching from the selected search range. This knob operates only in Custom Search and does not operate in other searches.

[SCAN / srch] key

Press this key to resume searching while monitoring a frequency.

[Hold /] key

Press this key to toggle Close Call functions.

Long press this key to start Close Call Only Mode.

[L/O] key

Press this key to go to Rvw Search L/O.

[1 - 3 / sr 1 - 3] key

Press this key to start searching the search range set at Set Search Key.

[4 / LEFT / ifx] Key

While monitoring a frequency, press this key to exchange IF(intermediate frequency).

[6 / RIGHT / disp] Key

Press this key to change the system ID display and system ID name display in custom search if C-Ch Only Mode is on.

[7 / att] key

Press this key to toggle the attenuator state for the search range.

Long press this key to toggle global attenuator.

[8 / rev] key

Long press this key to show the reverse frequency for the current frequency.

And release this key to return to the current frequency.

[9 / mod] Key

Press this key to change the modulation.

[0 / WX] key

Press this key to change WX Alert Priority Mode.

Long press this key to start WX Scan.

[E / yes / gps] key

Press this key to change to the GPS Mode.

[MENU] key

Press this key to go to Search for... in Service Search and Custom Search.

Press this key to go to Srch/CloCall Opt in Quick Search.

SEARCH HOLD MODE

Press [Hold / 

General Operation

The scanner monitors the frequency continuously. The scanner displays the search range name on the first line. In Quick Search, it displays "Quick Search" on the first line. The scanner displays the monitored frequency on the second line.

Turn [Scroll Control] to select the frequency.

Press [L/O] once to temporarily lock out the frequency. The scanner displays "Temporary L/O".

Press [L/O] twice in a second to permanently lock out the frequency. The scanner displays "Locked Out".

Press [L/O] on a locked out frequency to unlock it. The scanner displays "Unlocked".

Long press [L/O] to unlock all frequencies in the current search range. The scanner displays "Srch Lockouts" and "All Unlocked".

Press [SCAN / srch] in Function Mode or [Hold / 

Custom Search Range Select :

Turn [Scroll Control] knob in Function Mode to select the Custom Search Range. Once the Range is changed, the monitoring frequency is set to upper limit frequency or lower limit frequency depends on searching direction. If the direction is ascending order, the frequency is set to lower limit frequency of selected Range. Otherwise, if that is descending order, the frequency is set to upper limit frequency.

Press [Scroll Control] knob again or [SCAN / srch] key to start searching.

Go to Quick Search Hold Directly

When the scanner stops on a received signal or holds on in any Hold Mode, the user can go to Quick Search Hold Mode directly.

Enter a frequency using [0-9] and [. / no / pri] then press [Hold / 

Direct Entry

Enter the frequency or TGID by using the number and decimal keys, then press [E / yes / gps] key to quickly store a channel. (See: Direct Entry for details.)

Quick Save

Press [E / yes / gps] without entering data to quickly store the held frequency.

This Quick Save function is almost the same as Direct Entry.

(See: *Direct Entry* for details.)

The name of the stored frequency is the frequency when the scanner is not receiving location data from a GPS unit.

If you store the detected frequency while receiving location data from a GPS unit, the channel name of the stored frequency becomes the current Latitude/Longitude data.

The channel name format depends on the format set in *Set Pos Format*.

“DMS:DDD°MM’S.SS” is set

If the latitude data is “32°57’33.60 N” and the longitude data is “97°05’34.18 W”, the channel name becomes “3257.33-09705.34”.

“DEG:DD.dddddd” is set

If the latitude data is “32.959333 N” and the longitude data is “097.092827 W”, the channel name becomes “32.9593-097.0928”.

Key Operation During Search Hold Mode

Normal Mode

[Scroll Control] knob

Turn this knob to change the searching direction.

While monitoring a frequency, turn this knob to resume searching.

[SCAN / srch] key

Press this key to go to Scan Mode.

[Hold /] key

Press this key to resume searching.

[L/O] key

Press this key to temporarily lock out the current frequency. When the scanner is turned off, the frequency is unlocked.

Press this key twice in a second to permanently lock out the current frequency. When the scanner is turned off, the frequency stays locked.

Long press this key to unlock all frequencies that are locked out in Search Mode and Close Call Mode.

[1 - 9, 0] key

Press this key to enter numbers and go to Direct Entry.

[. / no / pri] key

Press this key to input decimal point, hyphen or “i” for Direct Entry.

[E / yes / gps] key

Press this key to quickly store the current frequency.

[MENU] key

Press this key to go to the Menu Mode at Top Menu.

Function Mode

[Scroll Control] knob

Turn this knob to select a custom search range. The monitored frequency is set to the upper limit frequency or lower limit frequency, depending on the search direction.

This knob operates only in Custom Search and does not operate in other searches.

[SCAN / srch] key

Press this key to resume searching while monitoring a frequency.

[Hold /] key

Press this key to toggle Close Call functions.

Long press this key to start Close Call Only Mode.

[L/O] key

Press this key to go to Rvw Search L/O.

[1 - 3 / sr 1 - 3] key

Press this key to start searching the search range set at Set Search Key.

[4 / LEFT / ifx] Key

Press this key to exchange IF(intermediate frequency) for the current frequency.

[6 / RIGHT / disp] Key

Press this key to change the system ID display and system ID name display if C-Ch Only Mode is on.

[7 / att] key

Press this key to toggle the attenuator state for the search range.

Long press this key to toggle global attenuator.

[8 / rev] key

Long press this key to show the reverse frequency for the current frequency.

And release this key to return to the current frequency.

[9 / mod] Key

Press this key to change the modulation.

[0 / WX] key

Press this key to change WX Alert Priority Mode.

Long press this key to start WX Scan.

[E / yes / gps] key

Press this key to change to the GPS Mode.

[MENU] key

*Press this key to go to Search for... in Service Search and Custom Search.

Press this key to go to Srch/CloCall Opt in Quick Search.

CLOSE CALL MODE

The basic Close Call feature allows the scanner to immediately lock onto a transmission above a threshold signal strength. The way the scanner treats a Close Call is based on settings of the menu at Srch/CloCall Opt and Close Call.

Display during Close Call Mode

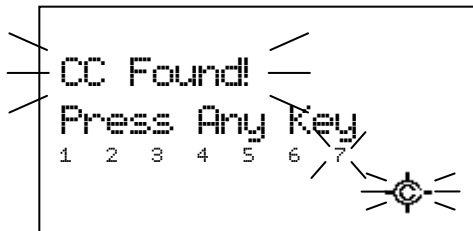

: This icon indicates when the Close Call Mode is "CC Pri".

: This icon indicates when the Close Call Mode is "CC DND".

Close Call Search

*Close Call function does not work in Temporary Hold or System Select of Scan Mode, Weather Scan Mode, Search and Store Mode and Tone-Out Mode.

**While the scanner is staying on a repeater frequency or a reverse frequency, it does not prompt for any new Close Call hits.

The scanner checks Close Call transmissions while scanning or searching every 2 seconds.

If a Close Call hit is found, the scanner alerts the user according to the setting of Set CC Alert, and the Close Call icon blinks.

CC DND is set:

The scanner does not make Close Call checks when it is already receiving a voice transmission.

"DND" means "Do Not Disturb".

CC Pri is set:

The scanner makes Close Call checks even if it is receiving a voice transmission.

You will notice a "gap" every two seconds when receiving a voice transmission.

CC Override is On:

When the scanner gets a Close Call hit, it displays as follows.

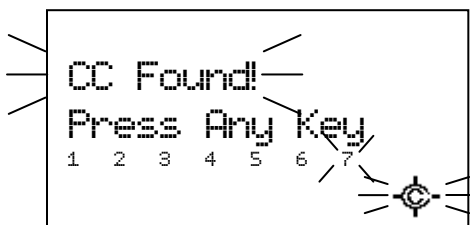

Press any key other than [Hold / ] to listen the detected frequency.

Press [Hold / 

If the scanner gets a Close Call hit in GPS Mode, it displays “Press FUNC Key” on the 4th line.

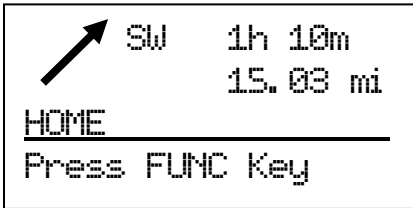

You can listen to the detected frequency by pressing [FUNC] or [Hold / 

CC Override is Off:

When the scanner gets a Close Call hit, it displays as follows.

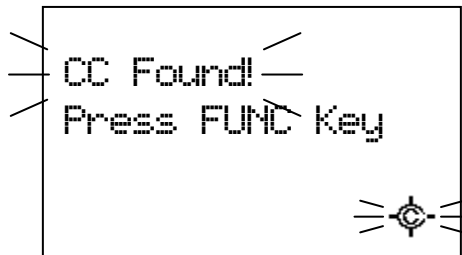

Press [FUNC] or [E / yes / gps] to listen to the detected frequency.

Press [. / no / pri] or don't press any key during the time that is set in Set CC Pause to ignore the Close Call hit and return to the previous state. In this state, pressing [Scroll Control], [L/O] or [Menu] operates the same as pressing [. / no / pri], and other keys are invalid.

If you ignored the hit during the CC Pause time, the scanner will not check for any Close Call transmission for 10 seconds.

Press [Hold / 

When the scanner gets a Close Call hit in GPS Mode, it displays “Press FUNC Key” on the 4th line and you can press [FUNC] or [Hold / 

Monitoring Close Call Transmission:

While monitoring a Close Call transmission, the scanner displays "Close Call" on the first line and the frequency on the second line. The modulation is displayed and the Close Call icon blinks.

If Attenuation, Broadcast Screen or Repeater Find for Srch/CloCall Opt are on, each icon is displayed.

For example, if the scanner finds a transmission on 462.7125 MHz, it displays as follows.

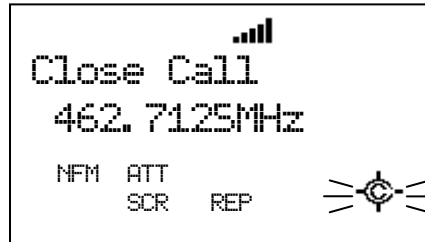

In this condition, the scanner does not check for other Close Call hits.

Press [Hold / 

Turn [Scroll Control] to cancel the monitoring condition. Then the scanner checks the remaining CC Bands. If it gets a Close Call hit, the scanner alerts again. Otherwise, it returns to the previous mode.

Press [L/O] once to temporarily lock out the frequency. The scanner displays "Temporary L/O".

Press [L/O] twice in a second to permanently lock out the frequency. The scanner displays "Locked Out" then resumes searching from the next frequency.

The scanner stays on the frequency until the Delay time expires even if the transmission ends. Then the scanner checks the remaining CC Bands. If it gets a Close Call hit, the scanner alerts again. Otherwise, it returns to the previous mode.

If all the bands are set to Off at Set CC Bands, the scanner does not check for Close Call hits. The scanner displays "Close Call" and "All Band Off!" and sounds an Error Tone when it tries to perform the Close Call check. Then the scanner sets CC Mode to Off of Set CC Mode.

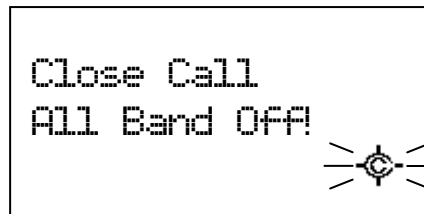

The scanner stays at this state.

In this state, press any key to turn all Close Call bands on.

Close Call Only

The scanner performs this by menu at Close Call Only. Or, long press [Hold / 

The scanner only tries to find a Close Call transmission.

“Close Call” will be displayed on the first line and the Close Call meter is displayed in the second line. This meter indicates the transmission signal level of each band.

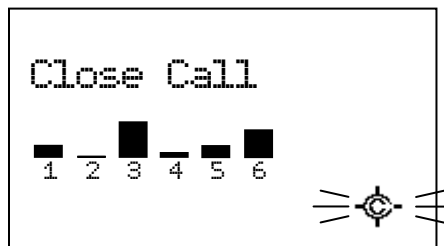

If the scanner has already received a Close Call hit and you press [Hold / 

Press the number keys from [1 / sr1] to [7 / att] to switch each band on or off. You can also use the menu to turn bands on or off. See Set CC Bands.

If the scanner gets a Close Call hit, the scanner displays "CC Found!" and "Press Any Key". And the band number that the found close call belongs to blinks.

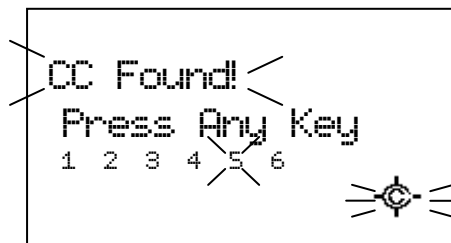

Press any key to see and hear the found frequency.

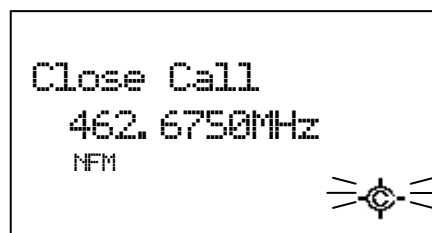

Press [Hold / 

In Close Call Only Mode, press [Menu] in Function Mode to go to Close Call Menu at Close Call.

Monitoring Close Call Transmission:

In this monitoring state, the scanner does not check other Close Call transmissions. Press [Hold / 

While the scanner is monitoring the transmission, turn [Scroll Control] to resume Close Call.

If all the bands are Off at Set CC Bands, the scanner cannot check for Close Call hits. The scanner displays "All Band Off!" and sounds an Error Tone. In this state, press any key to turn all the Close Call bands on.

Close Call Hold

In Close Call Hold, the scanner holds on the current Close Call hit frequency even if the transmission ends. The scanner displays "HOLD" and the held frequency. The Close Call Icon blinks and the modulation type is displayed.

For example, if the scanner finds a transmission on 174.0000 MHz, it displays as follows.

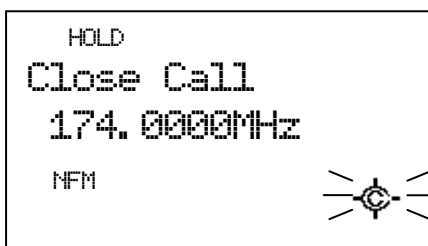

In this condition, the scanner does not check for other Close Call hits.

While holding on a frequency, turning [Scroll Control] goes to Quick Search Hold with the held frequency. And Close Call Mode will be set to off.

Press [Hold / 

*The previous state is one of these modes: Scan Mode, Scan Hold Mode, each Search Mode, each Search Hold Mode, Close Call Only Mode.

Close Call Auto Store

The scanner will automatically store Close Call hits. You can set this function using menu CC Auto Store.

During Close Call Auto Store operation, "SEARCH AND STORE" will scroll on the first Line and the Close Call meter that indicates the transmission signal level of each band will be shown in the second line.



If the scanner finds a Close Call transmission, it displays "CC Found!" on the first line. Then it performs duplication check in the "Close Call" System and displays "Memory Check" on the first line. While storing the frequency to Memory, it displays "Storing" on the first line.

The scanner will stop storing if the number of found frequencies reaches Max Auto Store. Then it displays "Limit Reached" and sounds a Confirmation Tone.

When it exceeds a limit for creating a System/Group/Channel while storing, the scanner stops storing. Then it displays "Over Limit" and sounds an Error Tone.

If the scanner's memory becomes full during the storing operation, it displays "Memory Full" on the first line and sounds an Error Tone.

The scanner does not automatically exit from CC Auto Store Mode.

Pressing [Hold / 

Pressing [Scan / srch] exits this mode and goes to Scan Mode.

Pressing [Menu] exits this mode and goes to Menu Mode. If you exit from Menu Mode, it goes to Close Call Only Mode.

Pressing [Menu] in Function Mode exits this mode and goes to the Close Call Menu.

Pressing [Scan / srch] in Function Mode prompts "Quick Search?" and exits this mode. Then press [E / yes / gps] to go to Quick Search Mode, press [. / no / pri] to go to Search Menu, press [L/O] to cancel the prompt and go to Close Call Only Mode, or press [Hold / 

CC Hit with Scan

The scanner stores the detected frequency in the "Close Call Hits" system. When the scanner is turned off, the stored frequencies are lost.

This system can store up to 10 frequencies. When there are already 10 frequencies in the "Close Call Hits" system, storing a new frequency overwrites the oldest one.

If this system does not have frequencies, the scanner does not scan this system.

The scanner does not store frequencies you skipped by pressing [L/O].

You set the Quick key, lockout state, number tag and hold time for this system at *Hits with Scan*.

Direct Entry / Quick Save / Go to Quick Search Hold Mode

Whenever it is in Close Call Hold Mode, you can enter a frequency or a TGID by pressing [0-9] or [. / no / pri] key, then press [E / yes / gps] to quickly store the entry.

(See *Direct Entry* for details.)

When the scanner monitors or holds on a Close Call transmission, press [E / yes / gps] to quickly store the current frequency.

While monitoring a Close Call frequency, if you turn [Scroll Control], the scanner goes to Quick Search Hold Mode with the frequency.

Key Operation During Close Call Only Mode

Normal Mode

[Scroll Control] knob

While monitoring a frequency, turn this knob to resume close call searching.

[Scan / srch] key

Press this key to go to Scan Mode.

[Hold /] key

If the scanner has already received a Close Call hit, press this key to hold on the frequency.

If not, the scanner will sound an Error Tone.

[L/O] key

While monitoring a frequency, press this key to temporarily lock out the current frequency. When the scanner is turned off, the frequency is unlocked.

Press this key twice in a second to permanently lock out the current frequency. When the scanner is turned off, the frequency stays locked out.

Long press this key to unlock all frequencies that are locked out in Search Mode and Close Call Mode.

[1 - 7] key

Press these keys to turn on/off each Close Call Band. This operation also can be done in menu Set CC Bands.

[E / yes / gps] key

While monitoring a frequency, press this key to quickly store the current frequency.

[Menu] key

Press this key to go to the Menu Mode at Top Menu.

Function Mode

[Scan / srch] key

Press this key to display the prompt for starting Quick Search.

The scanner displays the prompt. Press [E / yes / gps] to start Quick Search, press [./ no / pri] to go to Menu Mode at Search for..., press [L/O] to cancel the prompt or press [Hold / ] to go to Quick Search Hold Mode.

[Hold / ] key

Press this key to set the Close Call Mode to off and go to Scan Mode.

[L/O] key

Press this key to go to Rvw Search L/O.

[1 - 3 / sr 1 - 3] key

Press this key to start searching the search range set at Set Search Key.

[4 / LEFT / ifx] Key

While monitoring a frequency, press this key to exchange IF (intermediate frequency) for the current frequency.

[7 / att] key

Press this key to toggle the attenuator state for Close Call bands.

Long press this key to toggle the global attenuator status.

[8 / rev] key

Long press this key to show the reverse frequency for the current frequency.

And release this key to return to the current frequency.

[9 / mod] Key

Press this key to change the modulation.

[0 / WX] key

Press this key to change WX Alert Priority Mode.

Long press this key to start WX Scan.

[E / yes / gps] key

Press this key to change to the GPS Mode.

[Menu] key

Press this key to go to Close Call

Key Operation During Close Call Hold Mode

Normal Mode

[Scroll Control] knob

Turn this knob to go to the Quick Search Hold Mode.

[Scan / srch] key

Press this key to go to Scan Mode.

[Hold / ] key

Press this key to return to previous mode.

[L/O] key

Press this key to temporarily lock out the current frequency. When the scanner is turned off, the frequency is unlocked.

Press this key twice in a second to permanently lock out the current frequency. When the scanner is turned off, the frequency stays locked.

Long press this key to unlock all frequencies that are locked out in Search Mode and Close Call Mode.

[1 - 9, 0] key

Press this key to input a frequency or a TGID for Direct Entry.

[. / no / pri] key

Press this key to input "i" for Direct Entry.

[E / yes / gps] key

Press this key to quickly store the current frequency.

[Menu] key

Press this key to go to the Menu Mode at Top Menu.

Function Mode**[Scan / srch] key**

Press this key to display the prompt for starting Quick Search.

The scanner displays the prompt. Press [E / yes / gps] to start Quick Search, press [. / no / pri] to go to Menu Mode at Search for..., press [L/O] to cancel the prompt or press [Hold / 

[Hold / 

Press this key to set the Close Call Mode to off and go to Scan Mode.

[L/O] key

Press this key to go to Rvw Search L/O.

[1 - 3 / sr 1 - 3] key

Press this key to start searching the search range set at Set Search Key.

[4 / LEFT / ifx] Key

Press this key to exchange IF (intermediate frequency) for the current frequency.

[7 / att] key

Press this key to toggle the attenuator state for Close Call bands.

Long press this key to toggle the global attenuator status.

[8 / rev] key

Long press this key to show the reverse frequency for the current frequency.

And release this key to return to the current frequency.

[9 / mod] Key

Press this key to change the modulation mode.

[0 / WX] key

Press this key to change WX Alert Priority Mode.

Long press this key to start WX Scan.

[E / yes / gps] key

Press this key to change to the GPS Mode.

[Menu] key

Press this key to go to Close Call

WEATHER SCAN MODE

You can start scanning the 10 Weather Channels either by using the menu or by pressing Function and long pressing [0 / WX].

The scanner scans the 10 Weather Channels normally, or alerts when a 1050 Hz Weather Alert Tone or a SAME Weather Alert is broadcast on a Weather Channel.

You cannot lockout any Weather Channel.

*Close Call function does not work while during Weather Scan Mode even if "Set CC Mode" is "CC DND" or "CC Pri".

Normal Weather Scan

The scanner starts this when you select Weather Scan in Menu Mode at WX Operation.

The scanner scans 10 Weather Channels normally.

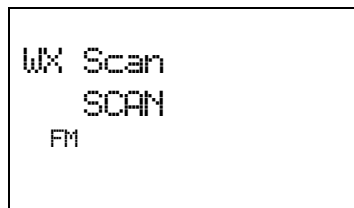

When it finds a broadcast, it stops on the Channel.



If the signal is lost, the scanner resumes scanning for Weather Channels.

Weather Alert Scan

The scanner starts this when you either select the Weather Alert function in Menu Mode at Weather Alert or press Function key and [0 / WX] key in Normal Weather Scan Mode to start this mode.

The scanner scans 10 Weather Channels and alerts when it detects a 1050 Hz Weather Alert Tone or a SAME Weather Alert.

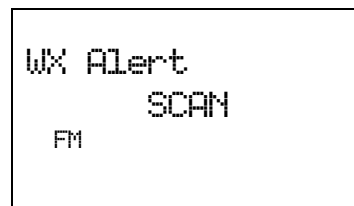

If it is set to Alert Only, the scanner immediately sounds a Weather Alert Siren (for Weather Alert Tone) and displays "Warning WX" and "WX Alert" when it detects the 1050 Hz Weather Alert Tone. This Siren sounds as long as 1050 Hz Weather Alert Tone is broadcasted, or press any key to stop the Siren. Then the scanner opens squelch and remains on the Weather Channel.

If you press any key, the scanner goes to WX Scan Hold Mode and releases the mute.

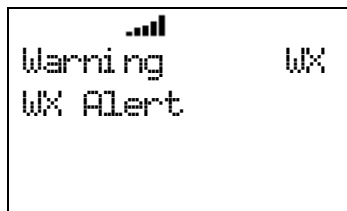

If the scanner is set to one of the SAME Groups, the scanner attempts to decode the SAME data packets that precede the Alert Tone. Then the scanner sounds a Weather Alert Siren (for Warning, Watch or Advisory) when the received County is the same as the programmed data. The scanner displays warning level as "Warning WX", "Watch WX" or "Advisory WX" on the first line and it displays the decoded Event Code on the second line. (See: [CEA2009-SAME EVENT CODE](#) for displayed characters.)

If you press any key, the scanner goes to Weather Scan Hold Mode and releases the mute and remains on the Weather Channel.

If the scanner decodes the EOM (= End of Message) in Weather Alert Scan Mode, it returns to the mute condition. However if the scanner is already in Weather Scan Hold Mode, it will not mute by decoding the EOM.

For example, the scanner displays as follows when it decodes the SAME data that has an Event Code of "EAN".

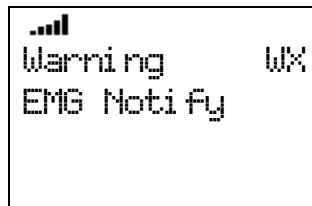

If the scanner is set to All FIPS, the scanner sounds a Weather Alert Siren (for Warning, Watch or Advisory) when it decodes the SAME data packets that precede the Alert Tone. It displays the warning level and Event Code, then opens squelch and remains on the Weather Channel.

*When the scanner detects the SAME data, it sounds each Weather Alert Siren for a maximum of 8 seconds. But you can suspend the siren by pressing any key.

*When the scanner detects the 1050 Hz Weather Alert Tone, it sounds Weather Alert Siren as long as 1050 Hz Weather Alert Tone is broadcasted, or press any key to stop the Siren.

Weather (Alert) Scan Hold

Press [Hold / 

The scanner displays "HOLD" icon and displays "WX Scan" or "WX Alert" on the first line and the Channel Number and frequency on the second line. The scanner checks only the held Channel.



The scanner does not sound until it detects the 1050 Hz Weather Alert Tone or decodes the SAME data in Weather Alert Scan Hold. See: [*Weather Alert Scan*](#) for operation when it detects the 1050 Hz Weather Alert Tone or decodes the SAME data.

Press [Hold / 

Weather Alert Priority (WX Alt Priority)

The scanner interrupts scanning or searching every 5 seconds and checks whether there is a 1050 Hz Weather Alert Tone on Weather Channels.

If the tone is detected, the scanner stays on to the Weather Channel and sounds a Weather Alert Siren (for Weather Alert Tone). Pressing any key stops this Siren.

After the Siren stops, the scanner opens squelch and remains on the Weather Channel.

If you presses any key again, the scanner goes to Weather Scan Hold Mode.

*WX Alt Priority function does not work while the scanner is in Weather Scan Mode, "Search and Store" Mode, Tone-Out Mode or CC Auto Store.

Direct Entry / Quick Save

When the scanner is holding on a Weather Channel, enter a frequency or TGID by pressing the number and decimal keys, then press [E / yes / gps] to quickly store the entered data.

When the scanner is holding or monitoring a Weather Channel, press [E / yes / gps] to quickly store the frequency.

Key Operation During Weather (Alert) Scan Mode

Normal Mode

[Scroll Control] knob

Turn this knob to resume Weather Scan.

[SCAN / srch] key

Press this key to go to Scan Mode.

[Hold /

Press this key to go to Weather Scan Hold Mode.

[E / yes / gps] key

Press this key to quickly store the current frequency.

[MENU] key

Press this key to go to the Menu Mode *at Top Menu*.

Function Mode

[SCAN / srch] key

Press this key to display the prompt for starting Quick Search.

The scanner displays the prompt. Press [E / yes / gps] to start Quick Search, press [./ no / pri] to go to Menu Mode at Search for..., press [L/O] to cancel the prompt or press [Hold / 

[1 - 3 / sr 1 - 3] key

Press this key to start searching the search range set at Set Search Key.

[4 / LEFT / ifx] Key

While monitoring a frequency, press this key to exchange IF(intermediate frequency).

[7 / att] key

Press this key to toggle the attenuator state for the search range.

Long press this key to toggle global attenuator.

[0 / WX] key

Press this key to change to WX Scan or WX Alert Scan.

If you press this key in WX Scan Mode, you can select how the WX Scan works and the scanner starts WX Alert Scan.

Or, the scanner immediately starts WX Scan when this key is pressed in any WX Alert Scan Mode.

[E / yes / gps] key

Press this key to change to the GPS Mode.

[MENU] key

Press this key to go to WX Operation.

Key Operation During Weather (Alert) Scan Hold Mode

Normal Mode

[Scroll Control] knob

Turn this knob to select the Weather Channel.

[SCAN / srch] key

Press this key to go to Scan Mode.

[Hold /

Press this key to resume each Weather Scan.

[1 - 9, 0] key

Press this key to enter numbers and go to Direct Entry.

[./ no / pri] key

Press this key to input decimal point, hyphen or “i” for Direct Entry.

[E / yes / gps] key

Press this key to quickly store the current frequency.

[MENU] key

Press this key to go to the Menu Mode *at* Top Menu.

Function Mode

[SCAN / srch] key

Press to display the Quick Search prompt. Press [E / yes / gps] to start Quick Search, press [. / no / pri] to go to Search for..., press [L/O] to cancel the prompt or press [Hold / 

[1 - 3 / sr 1 - 3] key

Press this key to start searching the search range set at Set Search Key.

[4 / LEFT / ifx] Key

Press this key to exchange IF(intermediate frequency) for the current frequency.

[7 / att] key

Press this key to toggle the attenuator state for the search range.

Long press this key to toggle global attenuator.

[0 / WX] key

Press this key to switch between WX Scan or WX Alert Scan. If you press this key in WX Scan Mode, you can select how the WX Scan works and the scanner starts WX Alert Scan. The scanner immediately starts WX Scan when this key is pressed in any WX Alert Scan Mode.

[E / yes / gps] key

Press this key to change to the GPS Mode.

[MENU] key

Press this key to go to WX Operation.

TONE-OUT MODE

Select "Tone-Out Standby" in *Tone-Out for ...*

Note: In this function, Close Call and WX Priority don't operate.

Display during Tone-Out Mode

Tone-Out Standby

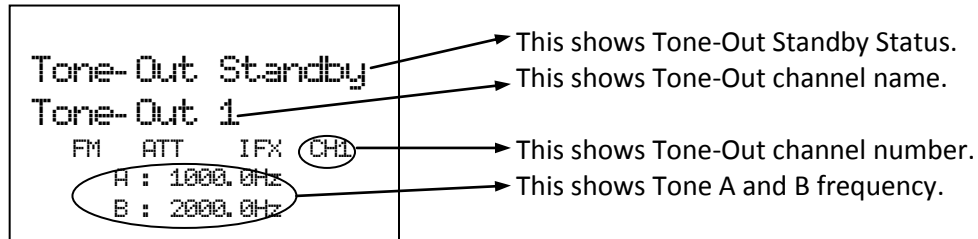

FM : These icons show the modulation type.

ATT : This icon shows the attenuator status of the current channel. When Global attenuator is on, this icon blinks.

IFX : This icon shows when the current channel is an IF exchange frequency.

Tone-Out Search

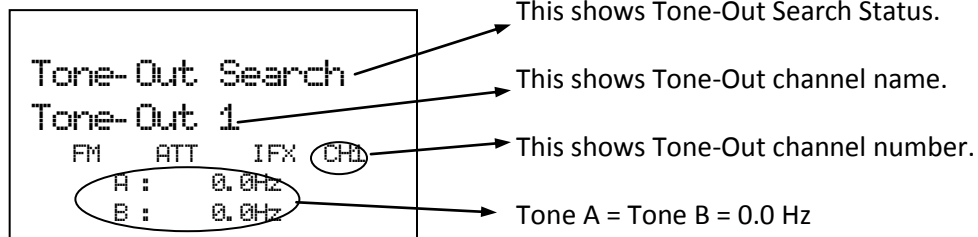

FM : These icons show the modulation type.

ATT : This icon shows the attenuator status of the current channel. When Global attenuator is on, this icon blinks.

IFX : This icon shows when the current channel is an IF exchange frequency.

Tone-Out Standby Mode

If at least one of Tone A and Tone B have a programmed tone, the scanner goes to Tone-Out Standby. While monitoring the Tone-Out frequency, the speaker is muted until matching Tones are detected.

- For two-tone pages, enter a value for Tone A and Tone B.
- For single-tone pages (alert by a single short tone), enter the tone value for Tone A and "0" for Tone B.
- For group tones (alert by a single long tone), enter "0" for Tone A and the tone value for Tone B.

When you set a tone value for Tone A and Tone B, if a transmission is detected, the scanner checks whether the tone is corresponding to Tone A.

If the first tone matches Tone A, the scanner confirms that the tone is present for more than 250ms.

Then the second tone is confirmed whether it detects second tone less than 500ms.

If the second tone matches Tone B and the tone is present for more than 100ms, the scanner opens squelch and activates the alert tone and alert light that you set for this tone set. Then the scanner goes to Tone-Out Hold Mode.

When you set a tone value for Tone A and "0" for Tone B, the scanner confirms that Tone A matches the first tone and is present for the following range.

Tone A: 1.25 – 3.75 sec

Then, the scanner goes to Tone-Out Hold Mode.

Or, when you set "0" for Tone A and a tone value for Tone B, the scanner confirms that Tone B matches the first tone and it is present for more than 3.75 sec.

Then, the scanner goes to Tone-Out Hold Mode.

Multi-Channel Monitoring

The scanner can check multiple tone combination for channels that have the same settings for frequency, Modulation and Attenuator.

For example, the scanner can check tone combination from CH 1 to CH3 at the same time when you program the scanner with the following settings.

	Frequency (MHz)	Modulation	Attenuator	Tone A (Hz)	Tone B (Hz)
CH 1	137.0000	Auto*(NFM)	Off	1000.0	2000.0
CH 2	137.0000	Auto*(NFM)	Off	2200.0	3200.0
CH 3	137.0000	NFM	Off	1500.0	2500.0
CH 4	137.0000	NFM	On	1800.0	2800.0
CH 5	137.0000	FM	Off	2000.0	3000.0
CH 6	138.0000	Auto*(NFM)	Off	1000.0	2000.0

*Modulation setting "Auto" follows the initialization of Band Coverage. However, when modulation of the frequency in Band Coverage is not FM or NFM, it is forced to FM. And "Auto" is compared as NFM or FM with other channel's setting.

*The scanner detects the Tone on the channel that its number is the smallest if you set the same tone in multiple channels.

While Tone-Out Standby Mode for Multi-Channel Monitoring, the scanner switches the channel display every 2 seconds. But the scanner checks all Tones for Multi-Channels simultaneously.

When one of the tone combinations is detected, it goes to Tone-Out Hold Mode.

Tone-Out Search Mode

When both Tone A and Tone B are set to 0.0Hz, this channel will be treated as a Tone-Out Search channel. The scanner starts the Tone-Out Search. During monitoring the Tone-Out frequency, the speaker is muted until Tones are detected.

In Tone-Out Search mode, if a transmission is detected, the scanner starts to check for two-tone pages, single-tone pages and group tones.

For two-tone pages, Tone A must be present for more than 250ms, Tone B must be present for more than 100ms, and the time gap between Tone A and Tone B must less than 500ms.

For single-tone pages, the Tone must be present between 1.25-3.75 seconds.

For group tones, Tone must be present for more than 3.75 seconds.

If one kind of these tones is detected, the scanner begins to check whether it has been registered in another tone-out channel with the same setting for frequency, Modulation and Attenuator. If it has been registered, the scanner goes to Tone-Out Hold Mode with the registered channel number. If not, the scanner goes to Tone-Out Hold Mode with the current Tone-Out search channel number.

Note: A Tone-Out Search channel is not treated as Multi-Channel even it has the same setting of frequency, Modulation and Attenuator with other channels.

When in Tone-Out Search Mode, scanner will not switch the channel display each 2 seconds for the Multi-Channel.

Tone-Out Hold Mode

You can hear the transmission in Hold Mode. When the transmission ends and the delay time expires, the scanner returns to standby condition or search condition. Or pressing [Hold / 

You can change to Hold Mode from Standby Mode of Search Mode by pressing [Hold / 

If the scanner detects a new tone-out sequence that has not been register yet. The found tone-out sequence will flash.

You can return to the Tone-Out Search Mode by pressing [Hold / 

If you press [E / yes / gps], you will be prompted to save the new detected tone-out sequence.

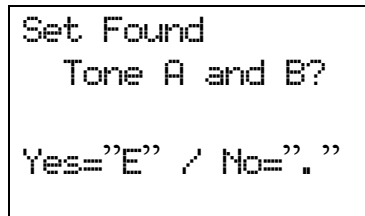

```
Set Found
Tone A and B?
Yes="E" / No="."
```

Press [E / yes / gps] to save the new tone-out sequence and move to the tone-out setting menu Tone-Out Settings. Press [/ no / pri] to cancel the new tone-out sequence and move to the tone-out setting menu Tone-Out Settings.

Note: If you change the Channel by turning the scroll control when in Hold Mode, the Hold condition is canceled and it moves to next channel.

Key Operation During Tone-Out Mode

Normal Mode

[Scroll Control] Knob

Turn this knob to change the channel. Then the scanner is muted if it releases the mute.

[Scan / srch] key

Press this key to go to Scan Mode.

[Hold /] Key

In Tone-Out Standby Mode or Tone-Out Search Mode, press this key to go to Tone-Out Hold Mode and release the mute.

In Tone-Out Hold Mode, press this key to go to Tone-Out Standby Mode or Tone-Out Search Mode, and the scanner is muted.

[1 - 9, 0] key

Press this key to enter a frequency or a TGID for Direct Entry.

[. / no / pri] key

Press this key to input "i" for Direct Entry.

[E / yes / gps] key

Press this key to go to the channel menu at *Tone-Out Settings*.

[Menu] Key

Press this key to go to the Menu Mode *at* Top Menu.

[L/O] Key

This key will be ignored.

Function Mode

[Scan / srch] key

Press this key to display the prompt for starting Quick Search.

The scanner displays the prompt. Press [E / yes / gps] to start Quick Search, press [. / no / pri] to go to Menu Mode at Search for..., press [L/O] to cancel the prompt or press [Hold / 

[Hold /

Press this key to go to Close Call Mode.

Long press this key to go to Close Call Only Mode

[1 - 3 / sr 1 - 3] key

Press this key to start searching the search range set at Set Search Key.

[4 / LEFT / ifx] key

Press this key to exchange IF (intermediate frequency) for the current frequency.

[7 / att] key

Press this key to toggle the attenuator setting.

Long press this key to toggle the global attenuator setting.

[9 / mod] key

Press this key to change the modulation.

[0 / WX] key

Press this key to change WX Alert Priority Mode.

Long press this key to start WX Scan.

[E / yes / gps] key

Press this key to change to the GPS Mode.

[Menu] key

Press this key to go to Tone-Out for

GPS MODE

By connecting a GPS Unit, the scanner can operate the following functions.

- Automatic lockout control for Scan Systems, Sites, and Channel Groups
- Navigation to POI (Point Of Interest)
- Location Alerts

This mode guides to the destination by connecting a GPS Unit to the serial port of the scanner and receiving location data through it.

You must set the scanner's baud rate to the same as the GPS unit. This is normally 4800 bps

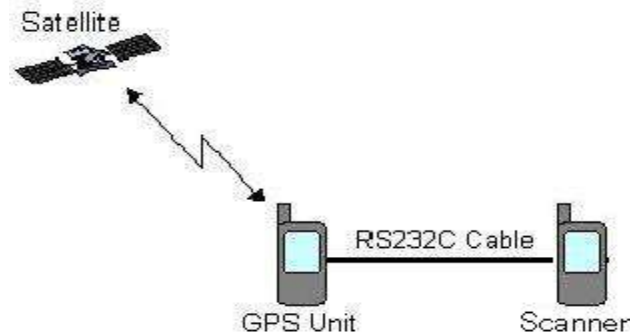

The formats of the GPS data that the scanner can receive are only GGA (Global Positioning System Fix Data) and RMC (Recommended Minimum Specific GNSS Data) based on "NMEA-0183 ver.3.01".

Display Mode in GPS Mode

There are 6 kinds of Display Mode in GPS Mode; GPS DATA, ETA, Clock, Elevation, Speed and Location. And there are two displays for a GPS Data receipt error.

If you do not select any POI, the Display Mode can be selected from GPS DATA and Location. Press [6 / RIGHT / disp] in Function Mode to change the Display Mode to the opposite side.

Or, if a POI is selected, the Display Mode can be selected from ETA, Clock, Elevation, Speed and Location. Press [6 / RIGHT / disp] in Function Mode to toggle the Display Modes in order.

*In GPS Mode, the 4th line displays the background operation of Scanner Mode. However, nothing is displayed on this area when the scanner goes to GPS Mode from Band Scope Mode.

Examples of each Display Mode are as follows.

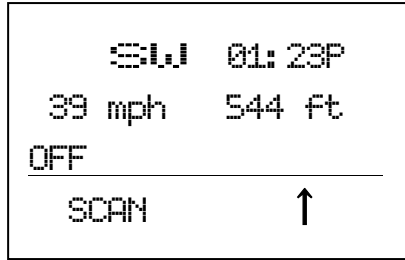

GPS DATA Display

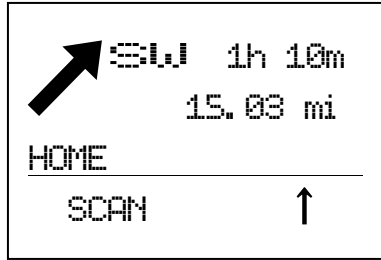

ETA Display

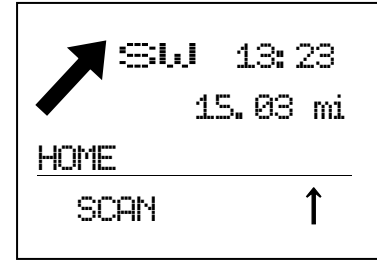

Clock Display

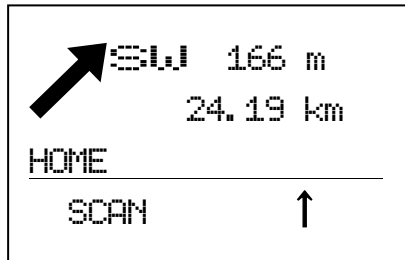

Elevation Display

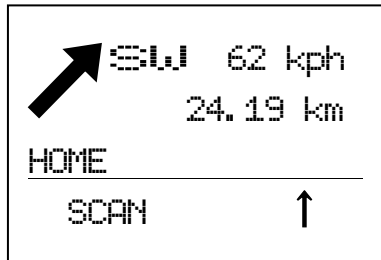

Speed Display

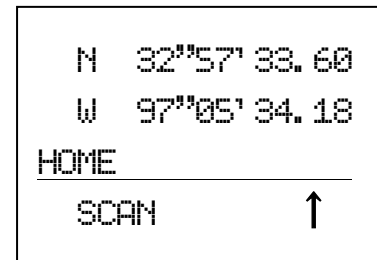

Location Display

GPS DATA Display

This Display Mode displays the direction of travel, the time, the speed and the elevation.

- The left side of the 1st line displays the current direction of travel.
- The right side of the 1st line displays the present time.
- The left side of the 2nd line displays the current speed.
- The right side of the 2nd line displays the elevation of the current location.
- The 3rd line always displays "OFF" because a POI is not selected.

ETA / Clock / Elevation / Speed Display

These Display Modes display the direction and the distance for the selected POI, the direction of travel and individual information.

- The large arrow shows the direction to the selected POI.
- The left side of the 1st line displays the current direction of travel.
- The 2nd line displays the distance to the selected POI.
- The right side of the 1st line displays individual information.
 - ETA Display Mode shows the ETA (Estimated Time for Arrival) to the selected POI.
 - Clock Display Mode shows the present time.
 - Elevation Display Mode shows the elevation of the current location.
 - Speed Display Mode shows the current speed.

The name of the selected POI is displayed on 3rd line.

Location Display

This Display Mode displays the latitude and longitude of the current location.

- The 1st line displays the latitude of the current location.
- The 2nd line displays the longitude of the current location.
- The 3rd line displays "OFF" (when a POI is not selected) or the name of the selected POI.

Display Formats of Each Information:

The advance direction:	This is one of N, NE, E, SE, S, SW, W and NW.
The time:	The time is displayed as " <i>hh:mm</i> " (<i>hh</i> : hour, <i>mm</i> : minute). If "12H" is selected at <u>Set Time Format</u> , "A" or "P" is displayed at a right end.
The speed:	This is a triple digits. According to the setting of <u>Set Unit</u> , "mph" (mile/hour) or "kph" (km/hour) is displayed for a unit.
The elevation:	This is displayed as " <i>EEEE</i> ft" (<i>EEEE</i> : elevation of a positive number) or " <i>-EEE</i> ft" (<i>EEE</i> : elevation of a negative number) using four digits. According to the setting of <u>Set Unit</u> , "ft" (feet) or "km" is displayed for a unit.
The direction for the POI:	One of eight directions is shown. There are "↑", "↗", "→", "↘", "↓", "↙", "←" and "↖". In Function Mode, this arrow changes to small one.
The distance for the POI:	This is displayed as " <i>DDDD.dd</i> mi" (<i>DDDD.dd</i> : distance). According to the setting of <u>Set Unit</u> , "mi" (mile) or "km" is displayed for a unit.
The ETA to the POI:	This is displayed as " <i>hhh mmm</i> " (<i>hh</i> : hour, <i>mm</i> : minute).
The latitude:	This is displayed as "N" or "S" and " <i>DD°MM'SS.ss</i> " (for DMS format) or " <i>DD.dddddd</i> " (for DEG format).
The longitude:	This is displayed as "W" or "E" and " <i>DDD°MM'SS.ss</i> " (for DMS format) or " <i>DDD.dddddd</i> " (for DEG format).

Error Display

When the scanner does not receive GPS data, the scanner displays "No GPS Input".

When the scanner is searching for the satellite, the scanner displays "Searching for Satellite".

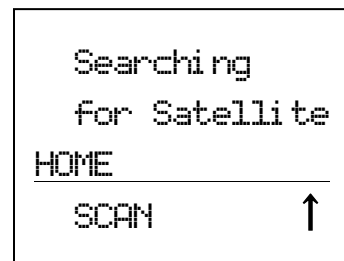
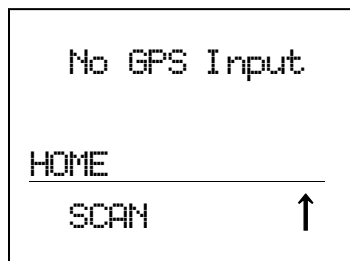

You can select a POI by turning [Scroll Control] knob even if the scanner displays an error message.

Location Alert Operation

This alerts you when you approach a destination, a Dangerous Xing or a Dangerous Road by ringing an alert.

Location Alert System Types have "POI (Point Of Interest)", "Xing (Dangerous Xing)" and "Road (Dangerous Road)".

Display with Location Alert

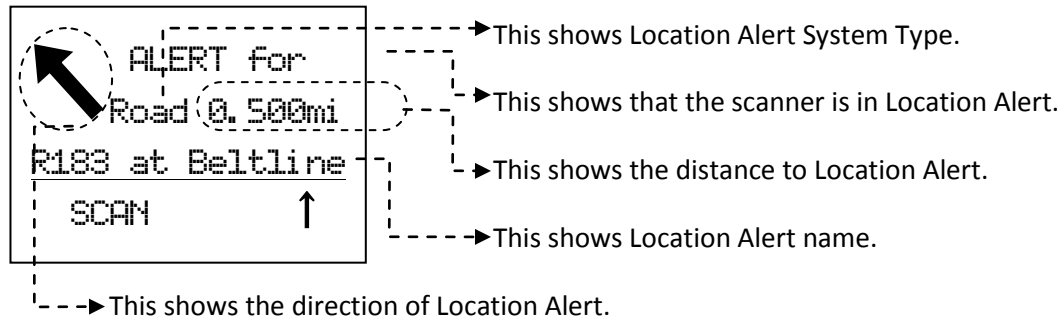

While displaying the **F** icon, Location Alert arrow changes to a small font.

Point Of Interest

The alerts you by ringing an alert if you approach the selected destination. The timing to which the alert rings is set up in Set LocationInfo. Or, the alert is set up in Set Alert.

The screen displays "ALERT for" on the first line. And the second line displays "POI" as Location Alert System Type and the distance to the destination.

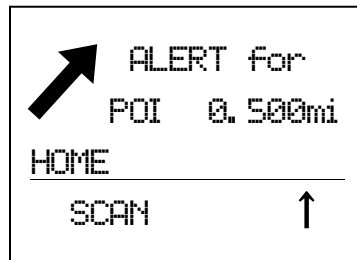

Dangerous Xing / Road

The scanner may ring an Alert three times at different timings.

The screen displays "ALERT for" on the first line. And the second line displays the Location Alert System Type and the distance to the Alert Location. An arrow which shows the direction of Alert Location is displayed too. Alert Light is turned on.(See: Set Alert Light.)

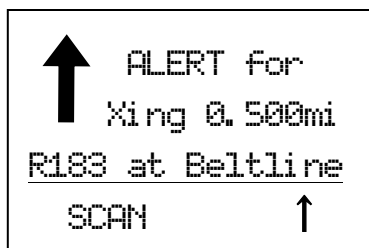

Dangerous Xing

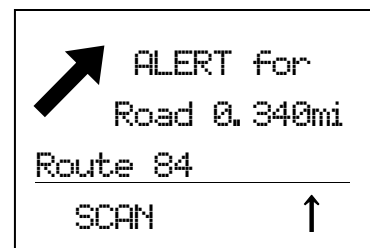

Dangerous Road

There are three ranges for Alert, 1.0mile, 0.50 mile and 0.10 mile if you select "mile" as the unit. If you select "km" as the unit, the alert distances are 1.0km, 0.50 km and 0.10 km. (See: Set Unit)

The scanner alerts only once for each range when it meets both of the following two conditions.

- First condition is heading for Alert Point. This is cleared when you heading is within $\pm 45^\circ$ of the value that is set in *Set Heading*.
- The second condition is speed. It meets this condition when the current speed exceeds the speed that is set in *Set Speed Limit*.

For example, see the following illustration. Car 1 is traveling within the range of the alert location point and its heading is within the point's set direction.

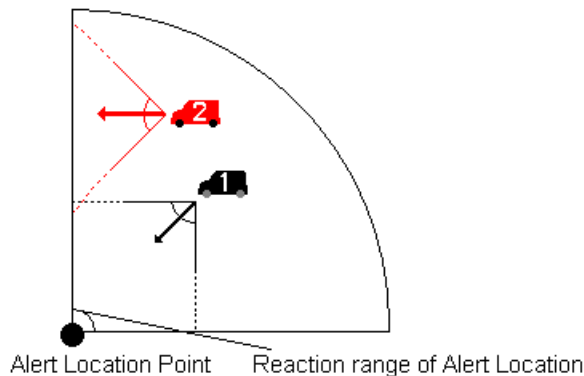

Car 2 is traveling within the range of the alert location, but its direction is outside the point's set direction.

If Car 1 is running at a speed higher than the limit set for the point, the scanner rings an Alert, the display changes to Location Alert Mode and the Alert Light is turned on.

If Car 1 is running at speed lower than the limit set for the point, the scanner does not ring an alert, the display changes to Location Alert Mode.

If Car 1 accelerates to a speed higher than the limit set for the point after it enters range, the scanner will ring an Alert and the Alert Light is turned on.

On the other hand, no Alert (Alert display, Alert Light, and Alert Beep) will sound for Car 2 regardless of its speed.

Lockout Operation

The scanner temporarily locks out the current Location Alert if you press [L/O] once while an alert for the location is active. The scanner automatically unlocks the locked out location when it moves 4 miles or more from the Alert Point.

The scanner permanently locks out the current Location Alert if you press [L/O] twice in a second. As long as you do not unlock the locked out location at menu (See: *Set Lockout*), Location Alert Operation and Alert Light for the locked out location does not work.

Turn [Scroll Control] during a location alert to temporarily lockout the displayed Location Alert.

Priority for Location Alert

When a Location Alert with a higher priority occurs during a Location Alert, the current Location Alert is canceled and the scanner alerts for the Location with the high priority.

The priority order is as follows:

- 1) Dangerous Road
- 2) Dangerous Xing
- 3) Point of Interest

GPS Operation during Scanner Display

If a Location Alert occurs when the scanner is displaying the scanner screen, the scanner displays the Location Alert data in reverse type on the bottom line and the Alert Light turns on. The scanner displays the direction of the Location Alert, Location Alert system type and the distance to the Location Alert.

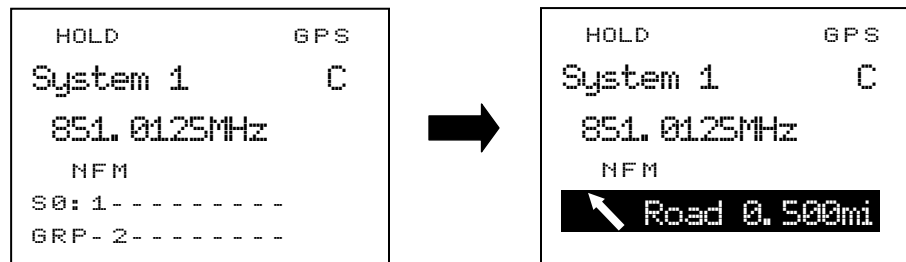

During the Location Alert, the scanner carries out the Location Alert operation with the scanner operation display. When the Location Alert operation finishes, the scanner returns to the usual scanner display.

Registration of Location Information

You can store current location data and the heading value by long pressing [E / yes / gps] key in Function Mode.

The moment you press [E / yes / gps] key in Function Mode, the scanner holds the current location data.

Then the scanner displays the dialog for selecting a location type. By pressing [E / yes / gps] for type selection, registration is completed and the name and location of stored location are displayed.

The stored data is named as "T YYMMDD hhmmss" that shows a type, date and the time.

Note: "T" means location system type. (P : POI / R : DRD / X : DXG) "YY" means year. "MM" means month. "DD" means day. "hh" means hour. "mm" means minute. "ss" means second.

For example, when a default name is "X 091020 102554", the system type is Dangerous Xing and was stored in 2009/10/20 10:25:54.

However, if the connection of GPS Unit is invalid, the scanner beeps an error tone when [E / yes / gps] is pressed.

*You can register current Location Information to a previously stored Location, too. For this operation, long press [FUNC] + [E / yes / gps] key in Review Location Mode. (See [Review Location Mode](#) for details.)

Review Location Mode

*In this mode, scanning/searching operation, navigation and Location Alert operation are invalid.

You can review all created Locations.

In GPS Mode, press [E / yes / gps] to go to Review Location Mode.

At first, the last displayed Location is selected.

The first line displays "Review Location" and the second line displays the Name of the Location. Location Type, Lockout status and GPS icon are displayed above the first line. Other parameters are displayed under the second line.

For POI, Range is displayed as "RANGE:0.10 MILE" or "RANGE:0.10 KM". For Dangerous Xing or Dangerous Road, Heading and Limit Speed are displayed as "HEAD:xxx" and "LS: 75M" (or "LS:75K"). The xxx is one of ALL, N, NE, E, SE, S, SW, W and NW.

Latitude and Longitude are displayed at the bottom of the screen.

Displays of each Type are as follows.

```
POI L/O GPS
Review Location
Hollywood
RANGE: 0.10 MILE
N 00°00'00.00
W 000°00'00.00
```

POI

```
DXG L/O GPS
Review Location
Crossroad
HEAD: ALL LS: 75M
N 00°00'00.00
W 000°00'00.00
```

Dangerous Xing

```
DRD L/O GPS
Review Location
Crossroad
HEAD: NW LS: 75K
N 00.000000
W 000.000000
```

Dangerous Road

Key Operation

Key Operation of Review Location Mode is different from normal GPS Mode.

Turn [Scroll Control]: Select a Location from all stored Locations. In this mode, Locations are sorted by Location Type. The order of Type is POI, Dangerous Xing and Dangerous Road. Locations are sorted by Name in each Type.

Turn [Scroll Control] in Function Mode: This skips to the location that starts with the next letter of the alphabet.

Press [SCAN / srch]: Go to Scan Mode.

Press [Hold / 

Press [L/O] key: Change the lockout status of the displayed Location.

Long press [L/O]: Unlock all Locations of the current Type. "Unlocked All TTTs?" and "Yes="E" / No="." are displayed. The "TTT" shows Location Type as POI, DXG or DRD.

	If you press [E / yes / gps], the scanner unlocks all locations of the current Type.
	If you press [. / no / pri], the scanner returns to the previous mode without unlocking.
Long press [L/O] in Function Mode:	Display the prompt "Unlock All Locations?" to unlock all Locations of all Types.
	If you press [E / yes / gps], the scanner unlocks all locations.
	If you press [. / no / pri], the scanner returns to the previous mode without unlocking.
Press [. / no / pri]:	Return to GPS Mode.
[E / yes / gps]:	Go to the location edit menu for the selected Location. <ul style="list-style-type: none"> • The construction of this edit menu is the same as the Menu of <i>POI Settings</i> or <i>Dangerous Xing / Road Settings</i>. However, pressing [MENU] in this edit menu returns to Review Location Mode, and pressing [L/O] in this menu goes to GPS Mode. • If you select "New Location" in the editing menu, the scanner returns to Review Location Mode with new Location activation. • If you select "Delete Location" in the editing menu, the scanner returns to Review Location Mode and the next Location is selected. If you've deleted all locations, the scanner returns to the GPS Mode immediately.
Long press [E / yes / gps] in Function Mode:	Overwrite the Latitude/Longitude of selected Location using the current Location Data from the GPS Unit. "Storing Location" is displayed and the scanner sounds an Exec Tone. <ul style="list-style-type: none"> • If the GPS connection is invalid, it can not overwrite and the scanner beeps an error tone when [FUNC] + [E / yes / gps] is pressed.
Press [MENU]:	Return to GPS Mode.

Key Operation During GPS Mode

*Refer to Review Location Mode for Key Operation of Review Location Mode.

Normal Mode

[Scroll Control] knob

Turn this knob to select a POI.

While displaying the **F** icon, the location alert arrow changes to a small font.

Turn this knob during a location alert to temporarily lockout the displayed Location Alert.

[SCAN / srch] key

Press this key to return to the previous mode in scanner screen.

[Hold /] key

This key works on scanner operation which is running in the background.

If scanner operation is Scan Mode or Search Mode, the scanner goes to Hold Mode by pressing this key. Or it is Scan Hold or Search Hold, the scanner resumes scanning or searching.

[L/O] key

Press this key once to temporarily lockout the current Location Alert during a Location Alert.

When the scanner is turned off, the frequency is unlocked. Or, the scanner automatically unlocks the locked out location when it moves 4 miles or more from the Alert Point.

Press this key twice in a second to permanently lockout the current Location Alert during a Location Alert.

When the scanner is turned off, these locations remain locked out.

[E / yes / gps] key

Press this key to go to Review Location Mode.

[MENU] key

Press this key to go to the Menu Mode at Top Menu.

Function Mode

[Scroll Control] knob

Turn this knob to skip to the location that starts with the next alphabetic character.

Press this knob to go to Normal Mode.

[L/O] key

Press this key once to temporarily lockout the current Location Alert during a Location Alert.

When the scanner is turned off, the frequency is unlocked. Or, the scanner automatically unlocks the locked out location when it moves 4 miles or more from the Alert Point.

Press this key twice in a second to permanently lockout the current Location Alert during a Location Alert.

When the scanner is turned off, these locations remain locked out.

[6 / RIGHT / disp] key

Press this key to change the GPS Display.

[E / yes / gps] key

Long press this key to store the current location.

[MENU] key

Press this key to go to the editing menu for the current location system.

OBAND SCOPE MODE

Band Scope Mode searches a frequency range and displays the signal level in real time.

You can set the center frequency and span of the frequency range.

In Hold Mode, you can monitor the displayed frequency.

*Close Call, Priority Scan, Weather Scan and GPS functions do not work in Band Scope Mode.

Scope Mode

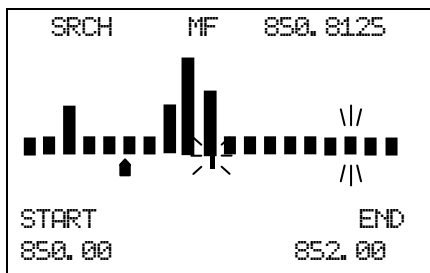

Search Mode with Normal Screen

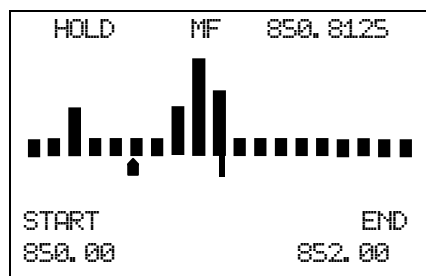

Hold Mode with Normal Screen

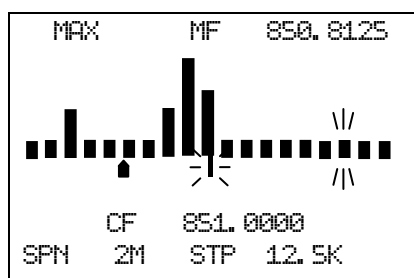

Search Mode with Setting Screen

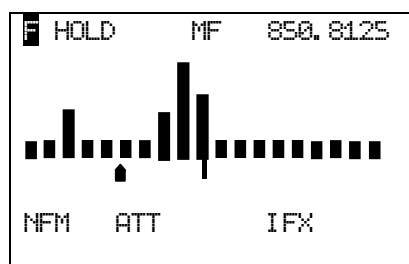

Hold Mode in Function Mode

SRCH	:	This icon appears while in Search Mode.
MAX	:	This icon appears while in MAX Hold Search Mode. This shows in the same place as " SRCH ".
HOLD	:	This icon appears while in Hold Mode. This shows in the same place as " SRCH ".
MF 850.8125:		This icon and number show the marker frequency.
■	:	This icon shows the signal level.
▲	:	This icon shows the marker point.
▼	:	This icon shows the center frequency point.
START 850.00 :		This icon and number shows the start frequency of the search range.
END 852.00 :		This icon and number shows the end frequency of the search range.
CF 851.0000 :		This icon and number shows the center frequency.
SPN 2M :		This icon and parameter shows the frequency span.
STP 12.5K:		This icon and parameter shows the search step.
NFM	:	This icon shows the modulation type.
ATT	:	This icon appears when the attenuator state for a range is On.
IFX	:	This icon appears on the frequency has IF exchange On.

Search Mode

The scanner searches and displays the signals of the frequency range in real time.

The scanner displays "SRCH".

The frequency range expressed in 32 bars is determined by the center frequency and span.

If the frequency range includes outside of the range from 25.0000 to 1300.0000 MHz, the scanner does not search that range.

While searching, the center frequency icon and the bar which shows the current frequency blink.

The scanner starts from the lowest frequency of the frequency range and searches in ascending order.

If the scanner finds a transmission, the scanner displays a signal level (0-7) in the bar including the frequency.

If the scanner finds some signals in the bar, the strongest and the latest signal are displayed.

Note: If a signal is outside of band coverage, the scanner doesn't search it.

Press [FUNC] + [Scan / srch] in Max Hold Search Mode to go to this mode.

Max Hold Search Mode

The scanner searches the signals of the frequency range.

The scanner displays the frequency for the strongest signal.

The scanner displays "MAX".

The other functions are the same as Search Mode.

Press [FUNC] + [Scan / srch] in Search Mode to go to this mode.

Hold Mode

You can monitor frequency displayed in this mode.

The scanner displays "HOLD".

Center frequency icon and bars do not blink different from Search or Max Hold Search Mode.

You can select the frequency to monitor by moving the marker pointer.

Turn Scroll Control, the marker changes the frequency every step.

Turn Scroll Control in Function Mode, the marker changes the frequency every bar.

Press [Hold / 

General Operation

Normal Screen

This screen is usually displayed in Band Scope Mode.

This screen displays the start and end frequency of the range on the bottom line.

You can control the marker to monitor a frequency in Hold Mode and register the marker frequency as the center frequency.

Setting Screen

This screen is displayed to operate the band scope settings.

This screen displays center frequency of the range, search step and span of the range on the bottom line.

You can change these parameters.

Press [./no/pri] while on the normal screen to display this screen.

In this screen, press [./no/pri] to select the next setting item.

The icon of the selected item blinks.

You can change the selected item's parameter (except "CF") by turning the Scroll Control.

When the "CF" is selected, go to the edit frequency menu to change the center frequency by pressing [E / yes / gps]. (See [Edit Frequency.](#))

If you change a parameter, the scanner clears the search result and searches again.

The scanner returns to a normal screen 10 seconds after the last operation or by pressing [L/O].

Function Mode

Press [FUNC] to go to Function Mode and display the modulation, the attenuator and IF Exchange.

Restart Searching

This function is used to clear the search result and search again.

You can restart searching by pressing [FUNC] + [L/O].

The scanner also restarts searching if you change any parameter or search mode.

In Hold Mode, the scanner searches a search range only once.

Search Setting Parameters

Center Frequency

This parameter is the center frequency of the search range.

*Please see: [Band Coverage](#) for acceptable frequencies.

When you go to Band Scope Mode from another mode with a frequency, the scanner sets that frequency as the center frequency.

Span

This parameter is the span of the search range.

You can select from 0.2 / 0.4 / 0.6 / 0.8 / 1 / 2 / 4 / 6 / 8 / 10 / 20 / 40 / 60 / 80 / 100 / 120 / 140 / 160 / 180 / 200 / 250 / 300 / 350 / 400 / 450 / 500 (MHz).

Search Step

You can change the search step to find a transmission.

The search time changes depending on the search step size.

You can select from 5 / 6.25 / 7.5 / 8.33 / 10 / 12.5 / 15 / 20 / 25 / 50 / 100 (kHz).

Modulation

Modulation can be selected from AUTO / AM / NFM / FM / WFM / FMB.

This parameter is used in HOLD Mode.

When you go to Band Scope Mode from another mode with a frequency, the scanner sets the other mode's modulation as Band Scope Mode's modulation.

Key Operation during Band Scope Mode

Normal Mode during Normal Screen

[Scroll Control] Knob

Sets the level in Volume / Squelch Level Control mode.

Turn this knob, the marker changes the frequency every step.

[Scan / srch] Key

Press this key to go to Scan Mode.

[Hold /] Key

In Search or Max Hold Search Mode, press this key to go to Hold Mode.

In Hold Mode, press this key to return to the previous search mode.

[./ no / pri] Key

Press this key to display a setting screen.

[E / yes / gps] Key

Press this key to register the marker frequency as the center frequency.

[Menu] Key

Press this key to enter the Menu Mode.

Normal Mode during Setting Screen

[Scroll Control] Knob

Sets the level in Volume / Squelch Level Control mode.

Turn this knob to change the selected item parameter except "CF" item.

[Scan / srch] Key

Press this key to go to Scan Mode.

[Hold /] Key

In Search or Max Hold Search Mode, press this key to go to Hold Mode.

In Hold Mode, press this key to return to the previous search mode.

[./ no / pri] Key

Press this key to select the next setting item.

[E / yes / gps] Key

When the "CF" item is selected, press this key to go to the edit menu for the center frequency.

[Menu] Key

Press this key to enter the Menu Mode.

Function Mode

[Scroll Control] Knob

Sets the level in Volume / Squelch Level Control mode.

Turn this knob, the marker changes the frequency every bar.

[Scan / srch] Key

Press this key in Search Mode to go to Max Hold Search Mode.

Press this key in Max Hold Search Mode to go to Search Mode.

In Hold Mode, press this key to restart searching.

[Hold /] Key

Press this key to toggle Close Call functions.

Long press this key to start Close Call Only Mode.

[L/O] Key

Press this key to restart searching.

[1 - 3 / sr1 - 3] Key

Press this key to start Service Search, Custom Search, Tone-Out Mode or Band Scope Mode in Set Search Key.

[4 / LEFT / ifx] Key

In Hold Mode, press this key to exchange IF(intermediate frequency).

[7 / att] key

Press this key to toggle the attenuator state for the search range.

Long press this key to toggle global attenuator.

[9 / mod] Key

Press this key to change the modulation.

[0 / wx] Key

Press this key to change WX Alert Priority Mode.

Long press this key to start WX Scan.

[E / yes / gps] Key

Press this key to change to the GPS Mode.

[Menu] Key

Press this key to enter the Menu Mode.

WIRED CLONE MODE

You can clone almost all the data of one scanner to another.

After connecting the two scanners, turn on the two scanners. Then select "Master" or "Slave" Wired Clone.

Confirm State

First, you select Master or Slave.



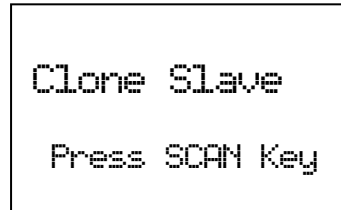

Master Unit



Slave Unit

Press [Scan / srch] on the Slave Unit, then on the Master Unit. The Master Unit checks whether the Slave Unit is connected correctly. When the Master Unit receives an acceptable response from the Slave Unit, the data transfer is started from the Master Unit to the Slave Unit. If the Master Unit doesn't receive an acceptable response in 10 second, it fails with an error.

Press [L/O] to return to Menu Mode at Wired Clone.

In the Slave Unit, when [Scan / srch] key is pressed and the display is "Clone Slave Waiting Data", the only control that will work is [ /  / ] for turning off the scanner and turning on the backlight.

Transferring State

During the data transfer, the scanners display a progress message. ("=" shows progressing transfer.)

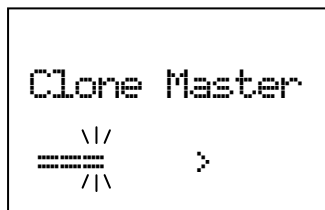

Master Unit

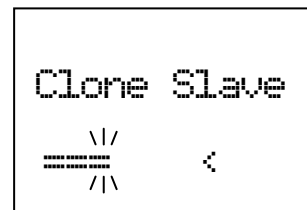

Slave Unit

Complete State

When the data transfer is completed, the scanners display "Complete".

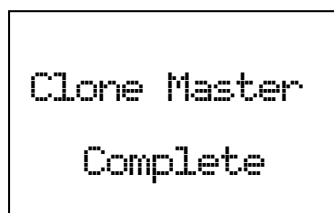

Master Unit

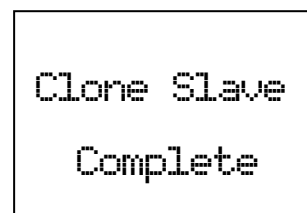

Slave Unit

Press [L/O] on the Master Unit to return to Confirm State.

When you reboot the Slave Unit, it has the new cloned data.

Note: When you reboot the Slave Unit, the Unit will check and erase the protected systems first, this process may take a few minutes which depend on the how many protected systems there are.

Error State

If the data transfer is not successful, the "Error" message appears.

Press [L/O] to return to Confirm State. Or power off the scanner.

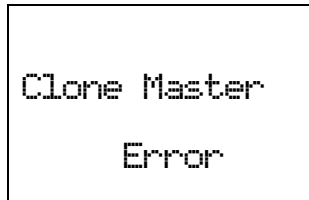

Master Unit

Note: The Slave Unit does not have an Error State. Even if the Slave Unit receives invalid data, it continues waiting for valid data.

Key Operation During Clone Mode



Confirm State

[Scan / srch] key : The scanner start data transfer.

[Menu] key : The scanner goes to Menu at Wired Clone



[FUNC] + [Menu] key : The scanner goes to Menu at Wired Clone

[L/O] key : The scanner goes to Menu at Wired Clone

[ /  / 



Another State

[L/O] key : The scanner goes back Confirm state. (Master Unit)





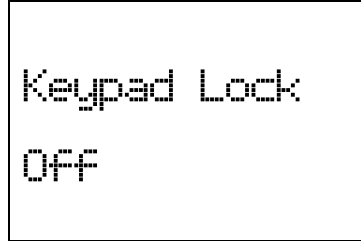

[ /  / 

Note: If you turn off the Slave scanner before cloning completes, memory is cleared when you turn the scanner back on.

KEYLOCK

Press [Func] + [ /  / 



While the keypad is locked, any key operation other than [Hold / , [ /  / , [Func] and turning [Scroll Control] key are invalid. (Of course, [Func] + [ /  / 

Pressing any other key causes the scanner displays "Keypad Lock" and "On" and does not sound any beep.



KEY SAFE MODE

This mode prevents accidentally changing parameter or modes. This mode is for handing the scanner to someone unfamiliar with its operation.

Some keys don't work in this mode.

Changed Key Operation in Key Safe Mode

The key in which a setting is applied showed in the following table.

		Scan	Service Search	Custom Search	Quick Search	WX	Close Call	Tone-Out	GPS	Band Scope
Normal Mode	Scan / srch		O ^{*1}	O ^{*1}	O ^{*1}	O	O	O	O	O
	Hold / 						O			
	L/O	O ^{*2}	O ^{*2}	O ^{*2}	O ^{*2}		O ^{*2,4}		O ^{*2}	
	1 - 3 / sr1 - 3									
	4 / LEFT / ifx									
	5 / lvl									
	6/RIGHT/ disp									
	7 / att									
	8 / rev									
	9 / mod									
	0 / wx									
	. / no / pri									
	E / yes / gps	O	O	O	O	O	O	O	O	O
Menu	O	O	O	O	O	O	O	O	O	
Function Mode	Scan / srch	O				O	O	O	O	
	Hold / 	O ^{*4}	O ^{*4}	O ^{*4}	O ^{*4}	O ^{*4}	O ^{*4}	O ^{*4}		O ^{*4}
	L/O		O	O	O		O			
	1 - 3 / sr1 - 3	O ^{*5}	O	O	O	O	O	O		O
	4 / LEFT / ifx	O ^{*5}	O ^{*3}	O ^{*3}	O ^{*3}	O ^{*3}	O ^{*3}	O		O
	5 / lvl	O ^{*5}								
	6/RIGHT/ disp									
	7 / att	O ^{*5}	O	O	O	O	O	O		O
	8 / rev									
	9 / mod	O ^{*5}	O	O	O		O	O		O
	0 / wx	O ^{*4,5}	O ^{*4}	O ^{*4}	O ^{*4}	O	O ^{*4}	O ^{*4}		O ^{*4}
	. / no / pri									
	E / yes / gps	O	O	O	O	O	O	O	O	O
Menu	O	O	O	O	O	O	O	O	O	

*¹ This key works as RESUME key in search hold mode.

*² You can control temporary L/O and unlock permanent L/O.

*³ This function is applied in hold mode or monitoring a transmission.

*⁴ Long press of this key does not work.

*⁵ This function is applied only in hold mode.

Key Safe Operation

Turns on power while pressing and holding [FUNC] key to go to the LAST MODE* in Key Safe Mode.

The scanner displays the “Key Safe Mode On” message after displaying the copyright message.

In Key Safe Mode, the on power supply while pressing and holding [FUNC] key to return to LAST MODE* in Full Operation. The scanner displays the “Key Safe Mode Off” message after displaying the copyright message.

If you try to set this function and Startup Key Operation together by pressing and holding [FUNC] key and the number key, the scanner does not set Key Safe Operation.

LAST MODE means the mode when the scanner is turned off. It resumes Scan Mode, Custom/Service/Quick Search Mode, Weather Mode, Close Call Only, Tone-Out Mode, each Hold Mode, GPS Mode and Band Scope Mode for LAST MODE.

In ID Search Hold Mode if ID has already been registered, LAST MODE will be ID Search Hold Mode. If ID has not been registered yet, LAST MODE will be Scan Mode.

Review Location Mode is set to normal Scanner Mode (not GPS Mode).

Key Safe Message

If you try to change a parameter or change to another mode, the scanner displays the following message and sounds an Error Tone.

```
Key Safe Mode  
Press FUNC while  
Power On for  
Full Operation
```

MEMORY INITIALIZATION

Press and hold [2 / sr 2], [9 / mod] and [Hold / 

The scanner clears all data and returns to initial setting. The display is as follows.

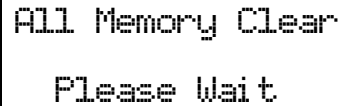

```
All Memory Clear
Please Wait
```

*If you unplug the AC Adapter or turn off the scanner during initialization, the scanner starts initializing again at next power on.

After clearing data, the scanner displays "Restore Preprogram List? Yes = "E" / No = "." " then you can select whether to restore the Preprogram List.

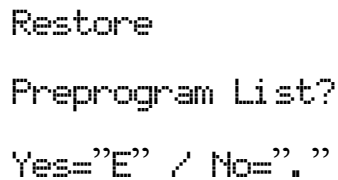

```
Restore
Preprogram List?
Yes="E" / No="."
|
```

Press [E / yes / gps] to restore the Preprogram List. Or, pressing / no / pri] to use without restoring the Preprogram List.

Then other keys are invalid and do not ring Key Beep.

If you press [E / yes / gps], the display is as follows.

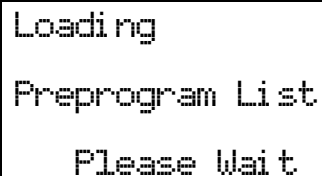

```
Loading
Preprogram List
Please Wait
```

BATTERY CHARGE

Battery Type Select

You can power the scanner non-rechargeable batteries (not supplied), nickel metal hydride (Ni-MH) rechargeable batteries or AC adapter.

You need to select the battery type before using batteries.

Turn off the scanner and remove the battery compartment cover. There is a switch to select the battery type like the following figure.

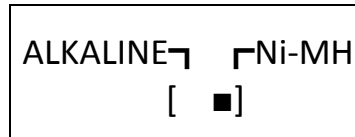

Set the switch to " Ni-MH " only if you are using Ni-MH batteries.

Set the switch to " ALKALINE " if you are using non-rechargeable batteries.

The scanner has a built-in circuit that charges the Ni-MH batteries.

To charge the batteries, connect the AC adapter to the scanner's power jack after installing the Ni-MH batteries with correct setting of the battery type switch.

The scanner charges the installed Ni-MH batteries. You can change the charging time.(See: [Set Charge Time](#))

*Never use non-rechargeable batteries in the scanner with the switch set to Ni-MH.

Charging the Battery

If an AC adapter is connected to the scanner, or a battery is installed to the scanner when an AC adapter is connected, the scanner will check the battery condition.

When the scanner is turned off:

If the battery is a rechargeable one, the scanner charges the battery.

The scanner displays "Normal Charging" while charging the battery.

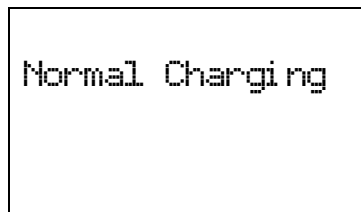

When the scanner charges the battery, it steps up the voltage gradually.

The scanner displays "Pre-Charging". "Pre-Charging" is a transition to the beginning of "Normal Charging".

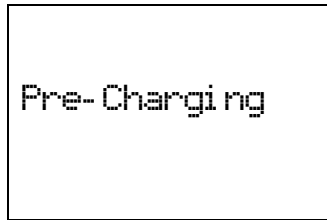

Pre-Charging

When the charge time elapses, it displays "Charge Complete".



Charge Complete

If a battery is not installed, it displays "No Battery".



No Battery

If the scanner detects that the battery cannot be charged, it displays "Battery Error".

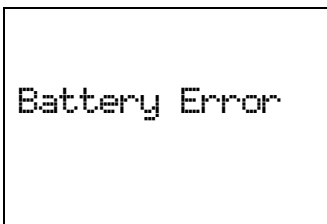

Battery Error

If there is a battery and Battery Type of the scanner is set to ALKALINE, it displays "Charge Off".

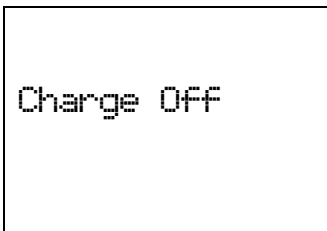

Charge Off

If the scanner detects an illegal voltage (voltage outside the allowable range), it displays "Illegal Voltage" and you cannot turn on power.

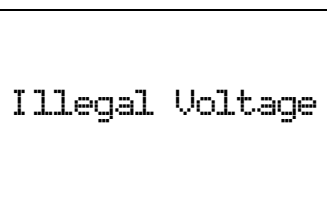

Illegal Voltage

When the scanner is turned on:

If the battery is good, the scanner charges the battery and it operates ordinarily. When the scanner cannot judge the battery to be a good one at once, the scanner checks the battery and the battery icon is displayed.

If the scanner judges the battery good, the scanner starts charging and the battery icon disappears.

If it cannot regard the battery as good within 60 seconds, the scanner stops checking and the battery icon blinks.

OTHERS

AVAILABLE SYSTEM SETTINGS

Different types of systems and sites have different settings available.

*In the following table, "CNV" means Conventional System.

System Settings

System Settings	CNV*	MOT	EDACS		LTR
			WIDE / NARROW	SCAT	
Edit Name	0	0	0	0	0
Edit Sys Option	0	0	0	0	0
Edit Site	---	0	0	0	0
Edit Group	0	0	0	---	0
Copy System	0	0	0	0	0
Delete System	0	0	0	0	0

System Option Settings

System Option Settings	CNV*	MOT	EDACS		LTR
			WIDE / NARROW	SCAT	
Set Quick Key	0	---	---	---	---
Set Startup Key	0	---	---	---	---
Set Number tag	0	0	0	0	0
Set Lockout	0	---	---	---	---
Set Hold Time	0	---	---	---	---
ID Scan/Search	---	0	0	---	0
Set Delay Time	0	0	0	0	0
Edit Fleet Map	---	0	---	---	---
Priority ID Scan	---	0	0	---	0
Set Status Bit	---	0	---	---	---
Set End Code	---	0	---	---	---
Emergency Alert	---	0	0	---	---
Set ID Format (DEC/HEX)	---	0	---	---	---
Set ID Format (AFS/DEC)	---	---	0	---	---
Rvw ID:Srch L/O	---	0	0	---	0
Clr All L/O IDs	---	0	0	---	0

Site Settings

Site Setting	MOT	EDACS		LTR
		WIDE / NARROW	SCAT	
Edit Name	0	0	---	0
Set Quick Key	0	0	0	0
Set Startup Key	0	0	0	0
Edit Band Plan	0	---	---	---
Set Site Type	---	0	---	---
Set Frequencies	0	0	0	0
Set Modulation	0	0	0	0
Set Attenuator	0	0	0	0
Set Lockout	0	0	0	0
Set Hold Time	0	0	0	0
Set C-Ch Only	0	---	---	---
Set LocationInfo	0	0	0	0
Delete Site	0	0	---	0
New Site	0	0	---	0

Site Frequency Settings

Site Frequency	MOT	EDACS		LTR
		WIDE / NARROW	SCAT	
Edit Frequency	0	0	0	0
Input LCN	---	0	---	0
Set Number tag	---	---	0	---
Set Lockout	0	0	0	0
Volume Offset	---	---	0	---
Delete Frequency	0	0	0	0
New Frequency	0	0	0	0

Channel Settings

Channel Settings	CNV*	MOT	EDACS		LTR
			WIDE / NARROW	SCAT	
Edit Name	0	0	0	---	0
Edit Frequency	0	---	---	---	---
Edit TGID	---	0	0	---	0
Set CTCSS/DCS	0	---	---	---	---
Set Number tag	0	0	0	---	0
Set Modulation	0	---	---	---	---
Set Attenuator	0	---	---	---	---
Set Priority	0	0	0	---	0
Set Alert	0	0	0	---	0
Set Lockout	0	0	0	---	0
Volume Offset	0	0	0	---	0
Copy Channel	0	0	0	---	0
Delete Channel	0	0	0	---	0
New Channel	0	0	0	---	0

TGID FORMAT FOR TRUNKED SYSTEM

[MOTOROLA TYPE1 SYSTEM]

Display Format

- | | |
|-----------|--|
| 1) BFF-SS | Normal ID
B is 1 digit
FF is 2 digits (0 filling)
SS is 1-2 digit(s) |
| 2) BFFF-S | Normal ID (when FLEET is 100-127)
B is 1 digit
FFF is 3 digits
S is 1 digit |
| 3) B---- | Partial ID (free FLEET and SUB-FLEET)
B is 1 digit |
| 4) BFF--- | Partial ID (free SUB-FLEET)
B is 1 digit
FF is 2 digits (0 filling) |
| 5) BFFF-- | Partial ID (free SUB-FLEET when FLEET is 100-127)
B is 1 digit
FFF is 3 digits |
| 6) NNNNN | Normal ID when SIZE CODE is 0
N is 1-5 digit(s) |
| 7) iNNNNN | I-CALL ID
N is 5 digits (0 filling) |

Input Format

- | | |
|-----------|---|
| 1) BFF-SS | Normal ID
B is 1 digit
FF should be 2 digits (0 filling)
SS is 1-2 digit(s) |
| 2) BFFF-S | Normal ID (when FLEET is 100-127)
B is 1 digit
FFF is 3 digits
S is 1 digit |
| 3) B- | Partial ID (free FLEET and SUB-FLEET)
B is 1 digit |
| 4) BFF- | Partial ID (fleet SUB-FLEET)
B is 1 digit
FF should be 2 digits (0 filling) |
| 5) BFFF- | Partial ID (fleet SUB-FLEET when FLEET is 100-127)
B is 1 digit
FFF is 3 digits |
| 6) NNNNN | Normal ID when SIZE CODE is 0
N is 1-5 digit(s) |
| 7) iNNNNN | I-CALL ID
N is 1-5 digit(s) |

Range

B : BLOCK (0-7)
FF(F) : FLEET
S(S) : SUB-FLEET

FLEET and SUB-FLEET maximum numbers depend on the SIZE CODE of each BLOCK in FLEET-MAP setting.

SIZE CODE 0:BLOCK0 : NNNNN (0- 8191)
BLOCK1 : NNNNN (8192-16383)
BLOCK2 : NNNNN (16384-24575)
BLOCK3 : NNNNN (24576-32767)
BLOCK4 : NNNNN (32768-40959)
BLOCK5 : NNNNN (40960-49151)
BLOCK6 : NNNNN (49152-57343)
BLOCK7 : NNNNN (57344-65535)
SIZE CODE 1 : FLEET (00-127) SUB-FLEET (0-3)
SIZE CODE 2 : FLEET (00-15) SUB-FLEET (0-7)
SIZE CODE 3 : FLEET (00-07) SUB-FLEET (0-7)
SIZE CODE 4 : FLEET (00) SUB-FLEET (0-15)
SIZE CODE 5 : FLEET (00-63) SUB-FLEET (0-3)
SIZE CODE 6 : FLEET (00-31) SUB-FLEET (0-7)
SIZE CODE 7 : FLEET (00-31) SUB-FLEET (0-3)
SIZE CODE 8 : FLEET (00-15) SUB-FLEET (0-3)
SIZE CODE 9 : FLEET (00-07) SUB-FLEET (0-3)
SIZE CODE 10 : FLEET (00-03) SUB-FLEET (0-7)
SIZE CODE 11 : FLEET (00-01) SUB-FLEET (0-15)
SIZE CODE 12 : FLEET (00) SUB-FLEET (0-15)
SIZE CODE 13 : FLEET (00) SUB-FLEET (0-15)
SIZE CODE 14 : FLEET (00) SUB-FLEET (0-15)

I-CALL ID : i00000-i65535

Note

The display format is also valid in remote command input.

[MOTOROLA TYPE2 SYSTEM]

<Decimal Format>

Display Format

- | | |
|-----------|-------------------------------|
| 1) NNNNN | Normal ID |
| | NNNNN is 1-5 digit(s) |
| 2) iNNNNN | I-CALL ID |
| | NNNNN is 5 digits (0 filling) |

Input Format

- | | |
|-----------|-----------------------|
| 1) NNNNN | Normal ID |
| | NNNNN is 1-5 digit(s) |
| 2) iNNNNN | I-CALL ID |
| | NNNNN is 1-5 digits. |

Range

Normal ID : 1-65535
I-CALL ID : i00000-i65535

Note

TYPE2 format cannot support PARTIAL ID.

<Hexadecimal Format>

Display Format

- | | |
|-----------|------------------------------|
| 1) NNNh | Normal ID |
| | NNN is 1-3 digit(s) |
| 2) iNNNNh | I-CALL ID |
| | NNNN is 4 digits (0 filling) |

Input Format

- | | |
|----------|---------------------|
| 1) NNN | Normal ID |
| | NNN is 1-3 digit(s) |
| 2) iNNNN | I-CALL ID |
| | NNNN is 1-4 digits. |

Range

Normal ID : 001 – FFF
I-CALL ID : i0000 – iFFFF

Note

TYPE2 format cannot support PARTIAL ID.
Normal ID: Hexadecimal Format omits lower 4 bit
Ex)
001h (Hex) -> 0016 (Dec)

[EDACS SYSTEM]

<AFS format>

Display Format

- | | |
|-----------|---------------------------------------|
| 1) AA-FFS | Normal ID |
| | AA is 2 digits (0 filling) |
| | FF is 2 digits (0 filling) |
| | S is 1 digit |
| 2) AA---- | Partial ID (free FLEET and SUB-FLEET) |
| | AA is 2 digits (0 filling) |
| 3) AA-FF- | Partial ID (free SUB-FLEET) |
| | AA is 2 digits (0 filling) |
| | FF is 2 digits (0 filling) |

Input Format

- | | |
|-----------|---------------------------------------|
| 1) AA-FFS | Normal ID |
| | AA should be 2 digits (0 filling) |
| | FF should be 2 digits (0 filling) |
| | S should be 1 digit |
| 2) AA- | Partial ID (free FLEET and SUB-FLEET) |
| | AA should be 2 digits (0 filling) |
| 3) AA-FF | Partial ID (free SUB-FLEET) |
| | AA should be 2 digits (0 filling) |
| | FF should be 2 digits (0 filling) |

Range

- | | |
|---------------|---------------------------|
| AA : AGENCY | 2digits (00-15) |
| FF : FLEET | 2digits (00-15) |
| S : SUB-FLEET | 1digit (0-7) |
| | *ALL0(00-00-0) is invalid |

Note

- Both AFS and Decimal Format are valid to input regardless of AFS setting.
- Display Format depends on AFS/Decimal setting except for I-CALL ID.
- Use Decimal format when I-CALL is needed.
- I-CALL format is always shown in Decimal Format regardless of AFS setting.
- AFS format cannot support I-CALL ID format.
- Display Format is also valid in remote command input.

<Decimal format>

Display Format

- | | |
|-----------|-------------------------------------|
| 1) NNNN | Normal ID |
| | NNNN is 1-4 digit(s) (no 0 filling) |
| 2) iNNNNN | I-CALL ID |
| | NNNNN is 5 digits (0 filling) |

Input Format

- | | |
|-----------|-----------------------|
| 1) NNNN | Normal ID |
| | NNNN is 1-4 digit(s) |
| 2) iNNNNN | I-CALL ID |
| | NNNNN is 1-5 digit(s) |

Range

Normal ID : 1-2047
I-CALL ID : i00000-i16383

Note

- Both AFS and Decimal Format are valid to input regardless of AFS setting.
- Display Format depends on AFS/Decimal Setting except for I-CALL ID.
- I-CALL format is always showed as Decimal Format regardless of AFS setting.
- Decimal format cannot support Partial ID.

[LTR SYSTEM]

Display Format

- 1) A-RR-NNN Normal ID
 - A is 1 digit
 - RR is 2 digits
 - NNN is 3 digits
- 2) A-RR---- Partial ID
 - A is 1 digit
 - RR is 2 digits

Input Format

- 1) A-RR-NNN Normal ID
 - A is 1 digit
 - RR is 2 digits
 - NNN is 3 digits
- 2) ARRNNN Normal ID (Easy Way)
 - A is 1 digit
 - RR should be 2 digits (01-20)
 - NNN should be 3 digits (000-254)
- 3) A-RR Partial ID (free ID)
 - A is 1 digit
 - RR should be 2 digits (01-20)

Range

A	: AREA CODE	1digit (0 or 1)
RR	: HOME REPEATER	2digit (01-20)
NNN	: ID	3digit (000-254)

Note

LTR System has no I-CALL ID.

FLEET MAP

The range of TGIDs is from 0 to 65535. This range is split into 8 equal blocks, and each Block is set to one of 15 Size Codes.

The range of TGID	0 - 65535
Block 0	0 - 8191
Block 1	8192 - 16383
Block 2	16384 - 24575
Block 3	24576 - 32767
Block 4	32768 - 40959
Block 5	40960 - 49151
Block 6	49152 - 57343
Block 7	57344 - 65535

Size Code from 0 to 11 uses 1 Block, 12+ occupies multiple blocks.

"**Size Code 12**" occupies 2 Blocks and this can be set to even Block numbers. If you try to set this to an odd Block number, it is set to the previous Block number.

The Block after the one you set to "Size Code 12" is also treated as "Size Code 12". This number does not appear in the Block selection.

For example, if you try to set Size Code 12 to Block 3, it is set to Block 2. Then the Block 3 is skipped because Block 2 is set to "Size Code 12". Block 2 and Block 3 are treated as "Size Code 12". Then the scanner advances to Block 4 to select its Size Code.

"**Size Code 13**" occupies 4 Blocks and this can be set only for Block 0 or Block 4. If you try to set this to Block number 1 - 3, it is set to Block 0. And if you try to set this to Block number 5 - 7, it is set to Block 4.

When you set a block to "Size Code 13", the following three blocks are also be treated as "Size Code 13".

The "**Size Code 14**" occupies all 8 Blocks. So, this Size Code can only be set for Block 0. If you try to set this to another Block, it is set to Block 0. Then only the Block 0 is displayed. All Blocks are treated as "Size Code 14".

If you change a Size Code from these 3 Codes to a Size Code which occupies a fewer number of Block, the scanner sets the other Blocks to "Size Code 0".

For example, if you changes the Block 0 from "Size Code 13" to "Size Code 5", the setting of Blocks are:
Block 0 = Size Code 5, Block 1 - 3 = Size Code 0.

Details of each Size Code are as follows.

Size Code	Fleet-SubFleet-ID	Number of Blocks occupied
0	(as Type II ID)	1
1	128-4-16	1
2	16-8-64	1
3	8-8-128	1
4	1-16-512	1
5	64-4-32	1
6	32-8-32	1
7	32-4-64	1
8	16-4-128	1
9	8-4-256	1
10	4-8-256	1
11	2-16-256	1
12	1-16-1024	2
13	1-16-2048	4
14	1-16-4096	8

*The numbers of "Fleet-SubFleet-ID" means the number of each. If the number of Fleets is 4, there are 4 Fleets and the range is from 0 to 3.

PRESET FLEET MAPS

*The numbers in the table shows the number of SIZE CODE.

BLOCK No.	0	1	2	3	4	5	6	7
Preset 1	11	11	11	11	11	11	11	11
Preset 2	4	4	4	4	4	4	4	4
Preset 3	4	4	4	4	4	4	12	(12)
Preset 4	12	(12)	4	4	4	4	4	4
Preset 5	4	4	12	(12)	4	4	4	4
Preset 6	3	10	4	4	12	(12)	12	(12)
Preset 7	10	10	11	4	4	4	4	4
Preset 8	1	1	2	2	3	3	4	4
Preset 9	4	4	0	0	0	0	0	0
Preset 10	0	0	0	0	0	0	4	4
Preset 11	4	0	0	0	0	0	0	0
Preset 12	0	0	0	0	0	0	0	4
Preset 13	3	3	11	4	4	0	0	0
Preset 14	4	3	10	4	4	4	12	(12)
Preset 15	4	4	4	11	11	0	12	(12)
Preset 16	3	10	10	11	0	0	12	(12)

WEATHER CHANNELS

The modulation for all Weather Channels is FM.

CH No.	Frequency
1	162.5500 MHz
2	162.4000 MHz
3	162.4750 MHz
4	162.4250 MHz
5	162.4500 MHz
6	162.5000 MHz
7	162.5250 MHz
8	161.6500 MHz
9	161.7750 MHz
10	163.2750 MHz

CTCSS FREQUENCY

The scanner can detect the following 50 CTCSS frequencies.

67.0Hz	88.5Hz	114.8Hz	151.4Hz	177.3Hz	203.5Hz	250.3Hz
69.3Hz	91.5Hz	118.8Hz	156.7Hz	179.9Hz	206.5Hz	254.1Hz
71.9Hz	94.8Hz	123.0Hz	159.8Hz	183.5Hz	210.7Hz	
74.4Hz	97.4Hz	127.3Hz	162.2Hz	186.2Hz	218.1Hz	
77.0Hz	100.0Hz	131.8Hz	165.5Hz	189.9Hz	225.7Hz	
79.7Hz	103.5Hz	136.5Hz	167.9Hz	192.8Hz	229.1Hz	
82.5Hz	107.2Hz	141.3Hz	171.3Hz	196.6Hz	233.6Hz	
85.4Hz	110.9Hz	146.2Hz	173.8Hz	199.5Hz	241.8Hz	

DCS CODE

The scanner can detect the following 104 hexadecimal DCS codes.

023	051	114	143	174	245	266	332	411	452	506	612	703
025	053	115	145	205	246	271	343	412	454	516	624	712
026	054	116	152	212	251	274	346	413	455	523	627	723
031	065	122	155	223	252	306	351	423	462	526	631	731
032	071	125	156	225	255	311	356	431	464	532	632	732
036	072	131	162	226	261	315	364	432	465	546	654	734
043	073	132	165	243	263	325	365	445	466	565	662	743
047	074	134	172	244	265	331	371	446	503	606	664	754

CEA2009-SAME EVENT CODE(ANSI/CEA-2009-A October 2005)

Standard	Event Code	EVENT LEVEL			LCD Display
		Warning			
			Watch	Advisory	
ADR	Administrative Message			O	Admin Message
AVA	Avalanche Watch		O		Avalanche
AVW	Avalanche Warning	O			Avalanche
BHW	Biological Hazard Warning	O			Biological
BWW	Boil Water Warning	O			Boil Water
BZW	Blizzard Warning	O			Blizzard
CAE	Child Abduction Emergency			O	Child Emergency
CDW	Civil Danger Warning	O			Civil Danger
CEM	Civil Emergency Message	O			Civil EMG
CFA	Coastal Flood Watch		O		Coastal Flood
CFW	Coastal Flood Warning	O			Coastal Flood
CHW	Chemical Hazard Warning	O			Chemical
CWW	Contaminated Water Warning	O			Contam. Water
DBA	Dam Watch		O		Dam Break
DBW	Dam Break Warning	O			Dam Break
DEW	Contagious Disease Warning	O			Contagious
DMO	Practice/Demo			O	System Demo
DSW	Dust Storm Warning	O			Dust Storm
EAN	Emergency Action Notification	O			EMG Notify
EAT	Emergency Action Termination			O	EMG Terminate
EQW	Earthquake Warning	O			Earthquake
EVA	Evacuation Watch		O		Evacuate Note
EVI	Immediate Evacuation	O			Evacuate Note
FCW	Food Contamination Warning	O			Food
FFA	Flash Flood Watch		O		Flash Flood
FFS	Flash Flood Statement			O	Flash Flood
FFW	Flash Flood Warning	O			Flash Flood
FLA	Flood Watch		O		Flood
FLS	Flood Statement			O	Flood
FLW	Flood Warning	O			Flood
FRW	Fire Warning	O			Fire
FSW	Flash Freeze Warning	O			Flash Freeze
FZW	Freeze Warning	O			Freeze
HLS	Hurricane Statement			O	Hurricane
HMW	Hazardous Material Warning	O			Hazardous
HUA	Hurricane Watch		O		Hurricane
HUW	Hurricane Warning	O			Hurricane
HWA	High Wind Watch		O		High Wind
HWW	High Wind Warning	O			High Wind

IBW	Iceberg Warning	0			Iceberg
IFW	Industrial Fire Warning	0			Industrial Fire
LAE	Local Area Emergency			0	Local EMG
LEW	Law Enforcement Warning	0			Law Enforcement
LSW	Land Slide Warning	0			Land Slide
NAT	National Audible Test			0	National Audible
NIC	National Information Center			0	National Info
NMN	Network Notification Message			0	Network Message
NPT	National Periodic Test			0	Nation Period
NST	National Silent Test			0	Nation Silent
NUW	Nuclear Power Plant Warning	0			Nuclear Plant
POS	Power Outage Advisory			0	Power Outage
RHW	Radiological Hazard Warning	0			Radiological
RMT	Required Monthly Test			0	Monthly
RWT	Required Weekly Test			0	Weekly
SMW	Special Marine Warning	0			Special Marine
SPS	Special Weather Statement			0	Special WX
SPW	Shelter In-Place Warning	0			Shelter
SVA	Severe Thunderstorm Watch		0		Thunderstorm
SVR	Severe Thunderstorm Warning	0			Thunderstorm
SVS	Severe Weather Statement			0	Severe WX
TOA	Tornado Watch		0		Tornado
TOE	911 Telephone Outage Emergency			0	911 Phone Outage
TOR	Tornado Warning	0			Tornado
TRA	Tropical Storm Watch		0		Tropical Storm
TRW	Tropical Storm Warning	0			Tropical Storm
TSA	Tsunami Watch		0		Tsunami
TSW	Tsunami Warning	0			Tsunami
TXB	Transmitter Backup On			0	TX Backup On
TXF	Transmitter Carrier Off			0	TX Carrier Off
TXO	Transmitter Carrier On			0	TX Carrier On
TXP	Transmitter Primary On			0	TX Primary On
VOW	Volcano Warning	0			Volcano
WFA	Wild Fire Watch		0		Wild Fire
WFW	Wild Fire Warning	0			Wild Fire
WSA	Winter Storm Watch		0		Winter Storm
WSW	Winter Storm Warning	0			Winter Storm
**A	Unrecognized Watch		0		Unrecognized
**E	Unrecognized Emergency			0	Unrecognized
**S	Unrecognized Statement			0	Unrecognized
**W	Unrecognized Warning	0			Unrecognized

REMOTE COMMAND

【 Remote Communication Format 】

BPS rate : 4800/9600/19200/38400/57600/115200 bps
Start/Stop bit : 1 bit, 1 bit
Data Length : 8 bit
Parity Check : None
Code : ASCII
Flow Control : None
Return Code : Carriage Return only

【 FORMAT OF THIS DOCUMENT 】

<COMMAND NAME>

Summary explanation of the function of the command

Controller → Radio

Command format

Radio → Controller

Response format

NOTE

1. Commands are required to wait a response from the scanner, then, next command is accepted.
2. All memory access commands are acceptable in only Program Mode.
Use PRG command to enter Program Mode, and EPG command to exit.
3. Error messages aren't described for each command, but the scanner returns error message to the controller as follows.
 - 1) Command format error / Value error : ERR[\r]
 - 2) The command is invalid at the time : NG[\r]
 - 3) Framing error : FER[\r]
 - 4) Overrun error : ORER[\r]
4. [\r] means "to hit the Enter key" or "to send the Return code".
5. Several commands or responses with long format are described like multi-line because of the page width but their formats are only single line, actually.
In set command, only "," parameters are not changed.
6. The set command is aborted if any format error is detected.
7. [INDEX] or [xxx_INDEX] is the index of internal memory chain.
Dynamic Memory Allocation Structure always uses it as a handle to access data and to trace forward/reverse or up/down index.
The range of the index is from 1 to maximum memory block (about 45000).
8. [FRQ], [BASEx] and [LIMIT_x] are frequency format.
It is showed by 8 digit number without decimal point.
The order of the digits is from 1 GHz digit to 100 Hz digit.
ex. 08510125 means 851.0125MHz
9. [TGID] shows TGID format. The formats depend on Trunked System Type.
See another Appendix to get further information.
10. [NAME] shows each custom name. If you set only a space character, the name will return to default name.
11. [LATITUDE] shows North or South Latitude.
The data shows "DDMMSSsL" at DMS Format.

DD	:	Degree	(00 - 90 : Double figure fixation)
MM	:	Minute	(00 - 59 : Double figure fixation)
SSss	:	Second	(SS : 00 - 59 : Double figure fixation)

(ss : 00 - 99 : Double figure fixation)
 L : Bearing (N : North / S : South)
 ex) "North Latitude 40°42'51.12" shows "40425112N".

12. [LONGITUDE] shows West or East Longitude.

The data shows "DDMMSSssL" at DMS Format.

DDD : Degree (000 - 180 : Triple figure fixation)
 MM : Minute (00 - 59 : Double figure fixation)
 SSss : Second (SS : 00 - 59 : Double figure fixation)
 (ss : 00 - 99 : Double figure fixation)
 L : Bearing (W : West / E : East)
 ex) "West Longitude 74°00'23.05" shows "074002305W".

Remote Command List

No.	Category	Command	Function	Program Mode Only
	Remote Control	GID	Get Current TalkGroup ID Status	
		KEY	Push KEY	
		POF	Power Off	
		QSH	Go to quick search hold mode	
		QSC	Set current frequency and get reception status	
		CSC	Go to Custom search and get reception status	
		PWR	Get RSSI Level	
		STS	Get Current Status	
		GLG	Get Reception Status	
		JPM	Jump Mode	
		JNT	Jump to Number Tag	
		MNU	Menu Mode	
		System Information	MDL	Get Model Info
	VER		Get Firmware Version	
	Program Control Mode	PRG	Enter Program Mode	
		EPG	Exit Program Mode	
	System Settings	BLT	Get/Set Backlight	0
		BSV	Get/Set Battery Info	0
		COM	Get/Set COM port setting	0
		CLR	Clear All Memory	0
		KBP	Get/Set Key Beep and setting	0
		OMS	Get/Set Opening Message	0
		PRI	Get/Set Priority Mode	0
		AGV	Get/Set Auto Gain Control	0
		SCT	Get System Count	0
	Scan Settings	SIH	Get System Index Head	0
		SIT	Get System Index Tail	0
		QSL	Get/Set System/Site Quick Lockout	0
		QGL	Get/Set Group Quick Lockout	0

		CSY	Create System	0
		DSY	Delete System	0
		SIN	Get/Set System Info	0
		TRN	Get/Set Trunk Info	0
		AST	Append Site	0
		SIF	Get/Set Site Info	0
		MCP	Get/Set Motorola Custom Band Plan	0
		TFQ	Get/Set Trunk Frequency Info	0
		AGC	Append Channel Group	0
		AGT	Append TalkGroup ID Group	0
		DGR	Delete Group / Site	0
		GIN	Get/Set Group Info	0
		ACC	Append Channel / Trunk Frequency	0
		ACT	Append TalkGroup ID	0
		DCH	Delete Channel	0
		CIN	Get/Set Channel Info	0
		TIN	Get/Set TalkGroup ID Info	0
		GLI	Get Lockout TalkGroup ID (for Rvw L/O ID)	0
		SLI	Get Search L/O TalkGroup ID	0
		ULI	Unlock TalkGroup ID (for Rvw L/O ID)	0
		LOI	Lockout ID (TalkGroup ID)	0
		REV	Get Rev Index	0
		FWD	Get Fwd Index	0
		RMB	Get Remains of Memory Block	0
		MEM	Get Memory Used	0
	Location Setting	LIH	Get Location Alert System Index Head	0
		LIT	Get Location Alert System Index Tail	0
		CLA	Create Location Alert System	0
		DLA	Delete Location Alert System	0
		LIN	Get/Set Location Alert System Info	0
	Search / Close Call Settings	SCO	Get/Set Search/Close Call Settings	0
		BBS	Get/Set Broadcast Screen Band Settings	0
		SHK	Get / Set Search Key Settings	0
		GLF	Get Global Lockout Freq	0
		ULF	Unlock Global L/O	0
		LOF	Lock Out Frequency	0
		CLC	Get/Set Close Call Settings	0
	Service Search Settings	SSP	Get/Set Service Search Settings	0
	Custom Search Settings	CSG	Get/Set Custom Search Group	0
		CBP	Get/Set C-Ch Only Custom search MOT Band Plan	0
		CSP	Get/Set Custom Search Settings	0
	Weather Settings	WXS	Get/Set Weather Settings	0
		SGP	Get/Set SAME Group Settings	0
	Tone-Out Setting	TON	Get/Set Tone-Out Settings	0
	LCD Contrast Settings	CNT	Get/Set LCD Contrast Settings	0
	Scanner Option Settings	SCN	Get/Set Scanner Option Settings	0
	Volume Level Settings	VOL	Get/Set Volume Level Settings	

	Squelch Level Settings	SQL	Get/Set Squelch Level Settings	
	Default Band Coverage Settings	DBC	Get/Set Default Band Coverage Settings	0
	GPS Settings	GDO	Get/Set GPS Format	0
	Band Scope Settings	BSP	Get/Set Band Scope Settings	0
	IF exchange list Settings	GIE	Get Global IF exchange Frequency	0
		CIE	Clear IF exchange Frequency	0
		RIE	Register IF exchange Frequency	0
	TEST	BAV	Get Battery Voltage	
		WIN	Get Window Voltage	

<COMMAND GID>
Get Current TGID Status
Controller → Radio
GID[\r]
Radio → Controller
GID, [SITE_TYPE], [TGID], [ID_SRCH_MODE], [NAME1], [NAME2], [NAME3] [\r]

[SITE_TYPE] : Site Type
CNV : CONVENTIONAL system site
MOT : MOTOROLA system site
EDC : EDACS Narrow / Wide system site
EDS : EDACS SCAT system site
LTR : LTR system site

[TGID] : TGID
[ID_SRCH_MODE] : ID SCAN / ID SEARCH Mode
0:ID SCAN Mode / 1:ID SEARCH Mode)
[NAME1] : SYSTEM / SITE NAME (Alpha Tag)
[NAME2] : GROUP NAME (Alpha Tag)
[NAME3] : TGID NAME (Alpha Tag)

FUNCTION

This command return TGID currently displayed on LCD.
If you get the TGID once, the scanner returns , , , , , [\r] until next reception.

NOTE :

This command return , , , , , [\r], when TGID is not displayed.

<COMMAND KEY>

Push KEY

Controller → Radio

KEY, [KEY_CODE], [KEY_MODE] [\r]

Radio → Controller

KEY,OK[\r]

[KEY_CODE] M : MENU
F : FUNC
H : HOLD
S : SCAN/SEARCH
L : L/O
1 : 1
2 : 2
3 : 3
4 : 4
5 : 5
6 : 6
7 : 7
8 : 8
9 : 9
0 : 0
. (dot) : ./NO
E : E/YES
> : VFO RIGHT * Set "P" to KEY_MODE.
< : VFO LEFT * Set "P" to KEY_MODE.
^ : VFO PUSH
P : POWER/LIGHT/LOCK

[KEY_MODE] P : Press
L : Long Press
H : Hold (Press and Hold until Release receive)
R : Release (Cancel Hold state)

Ex.1) Press MENU KEY

→ KEY,M,P[\r]

← OK[\r]

Ex.2) Press F + SCAN KEY

→ KEY,F,P[\r] : Hold F KEY

← OK[\r]

→ KEY,S,P[\r] : Press SCAN KEY (F + SCAN KEY operation)

← OK[\r]

→ KEY,F,P[\r] : Release F KEY

→ OK[\r]

Ex.3) Press and Hold L/O KEY

→ KEY,L,L[\r]

← OK[\r]

The status of KEY HOLD does time-out in 10 seconds after having received the command of KEY HOLD when there is not communication. (For example, "KEY,F,H".)

```

<COMMAND POF>
  Power OFF
  Controller → Radio
POF[\r]
  Radio → Controller
POF,OK[\r]

```

Turns off the scanner.
 After this command, the scanner doesn't accept any command.

```

<COMMAND QSH>
  Go to quick search hold mode
  Controller → Radio
QSH, [FRQ], [RSV], [MOD], [ATT], [DLY], [RSV], [CODE_SRCH], [BSC], [REP], [RSV],
[RSV], [RSV], [RSV] [\r]
  Radio → Controller
QSH,OK[\r] or QSH,NG[\r]

```

```

[FRQ]           : Frequency (The right frequency)
[MOD]           : Modulation      (AUTO/AM/FM/NFM/WFM/FMB)
[ATT]           : Attenuation     (0:OFF / 1:ON)
[DLY]           : Delay Time      (-10,-5,-2,0,1,2,5,10,30)
[CODE_SRCH]    : CTCSS/DCS Search
                (0:OFF / 1: CTCSS/DCS)
[BSC]           : Broadcast Screen (16digit: #####.#)
                (each # is 0 or 1)
                0 means OFF
                1 means ON
                |||||||*+ Band10
                ||||||| :
                |||||||+---- Band 2
                |||||||+---- Band 1
                |||||+----- Reserve
                |||+----- NOAA WX
                ||+----- VHF TV
                |+----- UHF TV
                +----- FM
                +----- Pager
[REP]           : Repeater Find   (0:OFF / 1:ON)
[RSV]           : Reserve Parameter * This is always only ",".

```

This command is invalid when the scanner is in Menu Mode, during Direct Entry operation, during Quick Save operation.

FUNCTION

UASD specifies arbitrary frequency and changes to Quick Search Hold (VFO) mode. Parameter, such as STP, changes the contents of Srch/CloCall option.

Note:

Even when only [FRQ] parameter is set, this command will work.

<COMMAND QSC>

Set current frequency and get reception status

Controller → Radio

QSC, [FRQ], [RSV], [MOD], [ATT], [DLY], [RSV], [CODE_SRCH], [BSC], [REP], [RSV],
[RSV], [RSV], [RSV] [\r]

Radio → Controller

QSC, [RSSI], [FRQ], [SQL] [\r] or QSC, NG [\r]

[FRQ]	:	Frequency (The right frequency)	
[MOD]	:	Modulation (AUTO/AM/FM/NFM/WFM/FMB)	
[ATT]	:	Attenuation (0:OFF / 1:ON)	
[DLY]	:	Delay Time (-10,-5,-2,0,1,2,5,10,30)	
[CODE_SRCH]	:	CTCSS/DCS Search (0:OFF / 1: CTCSS/DCS Search)	
[BSC]	:	Broadcast Screen (16digit: #####.##)	
	(each # is 0 or 1)		..+- Band10
	0 means OFF		:
	1 means ON		+----- Band 2
			+----- Band 1
			+----- Reserve
			+----- NOAA WX
			+----- VHF TV
			+----- UHF TV
			+----- FM
			+----- Pager
[REP]	:	Repeater Find	(0:OFF / 1:ON)
[RSSI]	:	RSSI A/D Value	(0-1023)
[SQL]	:	Squelch Status	(0:CLOSE / 1:OPEN)
[RSV]	:	Reserve Parameter	* This is always only `,".

This command is invalid when the scanner is in Menu Mode, during Direct Entry operation, during Quick Save operation.

FUNCTION

UASD specifies arbitrary frequency and changes to Quick Search Hold (VFO) mode. Parameter, such as STP, changes the contents of Srch/CloCall option.

<COMMAND CSC>

Go to Custom search and get reception status

Controller → Radio

- ① CSC,ON[\r]
- ② CSC,OFF[\r]

Radio → Controller

- ① CSC,[RSSI],[FRQ],[SQL][\r]

CSC,[RSSI],[FRQ],[SQL][\r]

CSC,[RSSI],[FRQ],[SQL][\r]

....

....

....

CSC,[RSSI],[FRQ],[SQL][\r]

- ② CSC,OK[\r]
[RSSI] : RSSI A/D Value (0-1023)
[FRQ] : Current Frequency
[SQL] : Squelch Status (0:CLOSE / 1:OPEN)

This command outputs custom search status of each frequency sequentially.
Use CSC,OFF command to stop the output.

This command is invalid when the scanner is in Menu Mode, during Direct Entry operation, during Quick Save operation.

<COMMAND PWR>

*Get RSSI Level

Controller → Radio

PWR[\r]

Radio → Controller

PWR,[RSSI],[FRQ][\r]

[RSSI] : RSSI A/D Value (0-1023)
[FRQ] : Current Frequency

Returns current RSSI level and its frequency.
The order of the frequency digits is from 1 GHz digit to 100 Hz digit.

<COMMAND STS>

Get Current Status

Controller → Radio

STS[\r]

Radio → Controller

STS, [DSP_FORM], [L1_CHAR], [L1_MODE], [L2_CHAR], [L2_MODE], [L3_CHAR], [L3_MODE], [L4_CHAR], [L4_MODE], ..., [L8_CHAR], [L8_MODE], [SQL], [MUT], [BAT], [WAT], [RSV], [RSV], [SIG_LVL], [RSV], [BK_DIMMER] [\r]

- [DSP_FORM] : Display Form (4 - 8digit:#####)
(each # is 0 or 1) 0 means Small Font / 1 means Large Font.
- [L1_CHAR] : Line1 Characters 16char (fixed length)
- [L1_MODE] : Line1 Display Mode 16char
- [L2_CHAR] : Line2 Characters 16char (fixed length)
- [L2_MODE] : Line2 Display Mode 16char
- [L3_CHAR] : Line3 Characters 16char (fixed length)
- [L3_MODE] : Line3 Display Mode 16char
- [L4_CHAR] : Line4 Characters 16char (fixed length)
- [L4_MODE] : Line4 Display Mode 16char
- :
- [L8_CHAR] : Line8 Characters 16char (fixed length)
- [L8_MODE] : Line8 Display Mode 16char
- [SQL] : Squelch Status (0:CLOSE / 1:OPEN)
- [MUT] : Mute Status (0:OFF / 1:ON)
- [RSV] : Reserve Parameter * This is always only "0".
- [BAT] : Battery Low Status (0:No Alert / 1:Alert)
- [WAT] : Weather Alert Status (0:No Alert / 1: Alert / \$\$\$: Alert
SAME CODE)
- [SIG_LVL] : Signal Level (0 - 5)
- [RSV] : Reserve parameter, always ","
- [BK_DIMMER] : Backlight Dimmer (0:OFF / 1:Low / 2:Middle / 3:High)

NOTE :) Display Mode for Line1 - Line8
 (space) : NORMAL CHAR, *: REVERSE CHAR
 _ (Under bar) : Underline
 If all 16chars are normal, only "," is sent.

The number of [Lx_CHAR] and [Lx_MODE] depend on Display Form.

Ex.1)

```

┌-----┐
│ -- M E N U -- │   Squelch Status      : OPEN
│ Program System │   Mute Status          : OFF
│ Program Location│   Battery Low Status  : No Alert
│ Srch/CloCall Opt│   Weather Alert Status : No Alert
└-----┘
→ STS[\r]
← 1111,
   -- M E N U -- , ← [L1_CHAR]
   _____, ← [L1_MODE]
```



```

Program System , ← [L2_CHAR]
***** , ← [L2_MODE]
Program Location, ← [L3_CHAR]
, ← [L3_MODE]
Srch/CloCall Opt, ← [L4_CHAR]
, ← [L4_MODE]
1,0,0,0,,,0,,,[\r]

```

Returns current scanner status.

Ex.2)

```

┌-----┐
| HOLD L/O |
| System 1 | Squelch Status : CLOSE
| 851.0125MHz | Mute Status : ON
| P NFM ATT | Battery Low Status : No Alert
| S1: 5 | Weather Alert Status : Alert
| GRP 2 WX |
└-----┘

```

```

→ STS[\r]
← 011000,
    HOLD L/O , ← [L1_CHAR]
    , ← [L1_MODE]
    SYSTEM 1 , ← [L2_CHAR]
    , ← [L2_MODE]
    851.0125MHz , ← [L3_CHAR]
    , ← [L3_MODE]
    P NFM ATT , ← [L4_CHAR]
    , ← [L4_MODE]
    S1: 5 , ← [L5_CHAR]
    , ← [L5_MODE]
    GRP 2 WX, ← [L6_CHAR]
    , ← [L6_MODE]
0,1,0,0,,,1,,,[\r]

```

Returns current scanner status.

<COMMAND GLG>

Get Reception Status

Controller → Radio

GLG[\r]

Radio → Controller

GLG, [FRQ/TGID], [MOD], [ATT], [CTCSS/DCS], [NAME1], [NAME2], [NAME3], [SQL], [MUT],

[SYS_TAG], [CHAN_TAG], [RSV] [\r]

GLG,,,,,,,,, [\r]

- [FRQ/TGID] : Frequency or TGID
- [MOD] : Modulation (AM/FM/NFM/WFM/FMB)
- [ATT] : Attenuation (0:OFF / 1:ON)
- [CTCSS/DCS] : CTCSS/DCS Status (0-231)
*See CTCSS/DCS CODE LIST about the details of this code.
- [NAME1] : System, Site or Search Name
- [NAME2] : Group Name
- [NAME3] : Channel Name
- [SQL] : Squelch Status (0:CLOSE / 1:OPEN)
- [MUT] : Mute Status (0:OFF / 1:ON)
- [SYS_TAG] : Current system number tag (0-999/NONE)
- [CHAN_TAG] : Current channel number tag (0-999/NONE)
- [RSV] : Reserve parameter, always "",

Get reception status.

The Scanner returns GLG,,,,,,,,, [\r] until it detects a frequency or a TGID.

<COMMAND JPM>

Jump Mode

Controller → Radio

JPM, [JUMP_MODE], [INDEX] [\r]

Radio → Controller

JPM,OK[\r]

- [JUMP_MODE] : SCN_MODE Scan mode
- SVC_MODE Service Search mode
- CTM_MODE Custom Search mode
- CC_MODE Close Call Only mode
- WX_MODE WX SCAN mode
- FTO_MODE Tone-Out mode
- [INDEX] : SCN_MODE Channel Index
- SVC_MODE PublicSafety
- News
- HAM
- Marine
- Railroad
- Air
- CB
- FRS/GMRS/MURS
- Racing
- FM
- Special

CTM_MODE	RESERVE
CC_MODE	RESERVE
WX_MODE	NORMAL
	A_ONLY
	SAME_1
	SAME_2
	SAME_3
	SAME_4
	SAME_5
	ALL_FIPS
FTO_MODE	RESERVE

Note) Scanner returns NG in the state that the mode switch cannot be done.

<COMMAND MNU>

Menu Mode
 Controller → Radio
 MNU, [MENU_INDEX] [\r]
 Radio → Controller
 MNU, OK [\r]

[MENU_INDEX]	:	SVC_MENU	:	Service Search Select Menu
WX_MENU	:		:	WX Select Menu
CCBAND_MENU	:		:	Close Call Band Filter Menu
SCR_OPT_MENU	:		:	Broadcast Screen Band Menu
GL_LIST_MENU	:		:	Search Global Lockout List Review Menu
SETTING_MENU	:		:	Setting Menu

Note) Scanner returns NG in the state that the mode switch cannot be done.

<COMMAND JNT>

Jump to Number Tag
 Controller → Radio
 JNT, [SYS_TAG], [CHAN_TAG] [\r]
 Radio → Controller
 JNT, OK [\r]

[SYS_TAG]	:	System Number Tag	(0-999/NONE)
[CHAN_TAG]	:	Channel Number Tag	(0-999/NONE)

When both [SYS_TAG] and [CHAN_TAG] are set as blank, scanner returns error.
 When [SYS_TAG] is set as blank, [CHAN_TAG] is set with a number tag, scanner jump to the channel number tag in current system.
 When [SYS_TAG] is set with a number tag, [CHAN_TAG] is set as blank, scanner jump to the first channel of the system number tag.

```
<COMMAND MDL>
  Get Model Info
  Controller → Radio
MDL[\r]
  Radio → Controller
MDL,BC346XT[\r]
```

Returns Model Information.

```
<COMMAND VER>
  Get Firmware Version
  Controller → Radio
VER[\r]
  Radio → Controller
VER,Version 1.00.00[\r]
```

Returns Firmware Version.

```
<COMMAND PRG>
  Enter Program Mode
  Controller → Radio
PRG[\r]
  Radio → Controller
PRG,OK[\r]
PRG,NG[\r]
```

This command is invalid when the scanner is in Menu Mode, during Direct Entry operation, during Quick Save operation.

The scanner goes to Program Mode.

The scanner displays "Remote Mode" on first line and "Keypad Lock" on second line in Program Mode.

```
<COMMAND EPG>
  Exit Program Mode
  Controller → Radio
EPG[\r]
  Radio → Controller
EPG,OK[\r]
```

The scanner exits from Program Mode.

Then the scanner goes to Scan Hold Mode.

<COMMAND BLT>

Get/Set Backlight
Controller → Radio
BLT[\r]
BLT, [EVNT], [RSV], [DIMMER] [\r]
Radio → Controller
BLT, [EVNT], [RSV], [DIMMER] [\r]
BLT,OK[\r]

[EVENT]

IF : INFINITE
10 : 10sec
30 : 30sec
KY : KEYPRESS
SQ : SQUELCH

[RSV] : Reserve parameter, always “,”
[DIMMER] : Backlight Dimmer (1:Low / 2:Middle / 3:High)

Get/Set Backlight Setting.

This command is only acceptable in Programming Mode.

<COMMAND BSV >

Get/Set Battery Info
Controller → Radio
BSV [\r]
BSV, [BAT_SAVE], [CHARGE_TIME] [\r]

Radio → Controller
BSV, [BAT_SAVE], [CHARGE_TIME] [\r]
BSV,OK[\r]

[BAT_SAVE] Battery Save (0:OFF / 1:ON)
[CHARGE_TIME] Battery Charge Time (1-16)

< COMMAND COM >
Get/Set COM port setting
Controller → Radio
COM, [/r]
COM, [BAUDRATE], [RSV] [/r]

Radio → Controller
COM, [BAUDRATE], [RSV] [/r]
COM, OK [/r]

[BAUDRATE]	:	
	OFF	:OFF
	4800	:4800bps
	9600	:9600bps
	19200	:19200bps
	38400	:38400bps
	57600	:57600bps
	115200	:115200b

Note:

When receive "COM,OK", next command should not be send in 2 second.
Only PC Control (Baud Rate) does not become an initial-setting value.

<COMMAND CLR>
Clear All Memory
Controller → Radio
CLR[\r]
Radio → Controller
CLR, OK [\r]

All the memories are set for initial setting.
This command is only acceptable in Programming Mode.

Note :

It takes dozens of seconds.

Only PC Control (Baud Rate) does not become an initial-setting value.

Memory index pointers are reset to "0". Some data may still exist in deleted memory area.

<COMMAND KBP>

Get/Set Key Beep and setting

Controller → Radio

KBP[\r]

KBP, [LEVEL], [LOCK], [SAFE] [\r]

Radio → Controller

KBP, [LEVEL], [LOCK], [SAFE] [\r]

KBP,OK[\r]

[LEVEL] : Beep Level (0:Auto / 1-15 / 99:OFF)
[LOCK] : Key Lock status (0:OFF / 1:ON)
[SAFE] : Key Safe status (0:OFF / 1:ON)

Get/Set Key Beep Setting.

This command is only acceptable in Programming Mode.

<COMMAND OMS>

Get/Set Opening Message

Controller → Radio

OMS[\r]

OMS, [L1_CHAR], [L2_CHAR], [L3_CHAR], [L4_CHAR] [\r]

Radio → Controller

OMS, [L1_CHAR], [L2_CHAR], [L3_CHAR], [L4_CHAR] [\r]

OMS,OK[\r]

[L1_CHAR] : Line1 Characters (max.16char)
[L2_CHAR] : Line2 Characters (max.16char)
[L3_CHAR] : Line3 Characters (max.16char)
[L4_CHAR] : Line4 Characters (max.16char)

If only space code is set in character area, the message returns default message.

This command is only acceptable in Programming Mode.

<COMMAND PRI>

Get/Set Priority Mode

Controller → Radio

PRI[\r] : Get Priority Mode Setting

PRI, [PRI_MODE], [MAX_CHAN], [INTERVAL] [\r]

Radio → Controller

PRI, [PRI_MODE], [MAX_CHAN], [INTERVAL] [\r]

PRI,OK[\r]

[PRI_MODE] : Priority Setting (0:OFF / 1:ON / 2:PLUS ON)
[MAX_CHAN] : Priority Scan max channels at once (1-100)
[INTERVAL] : Priority Scan Interval time (1-10)

Get/Set Priority Mode.

This command is only acceptable in Programming Mode.

```

<COMMAND SCT>
Get System Count
Controller → Radio
SCT[\r]
Radio → Controller
SCT,###[\r]      : ### (0 - 500)

```

Returns the number of stored System.
This command is only acceptable in Programming Mode.

```

<COMMAND SIH>
Get System Index Head
Controller → Radio
SIH[\r]
Radio → Controller
SIH,[SYS_INDEX][\r]

```

Returns the first index of stored system list.
This command is only acceptable in Programming Mode.

```

<COMMAND SIT>
Get System Index Tail
Controller → Radio
SIT[\r]
Radio → Controller
SIT,[SYS_INDEX][\r]

```

Returns the last index of stored system list.
This command is only acceptable in Programming Mode.

```

<COMMAND QSL>
Get/Set System/Site Quick Lockout
Controller → Radio
QSL[\r]
QSL,[PAGE0],[PAGE1],[PAGE2],[PAGE3],[PAGE4],[PAGE5],[PAGE6],[PAGE7],[PAGE8],
[PAGE9][\r]
Radio → Controller
QSL,[PAGE0],[PAGE1],[PAGE2],[PAGE3],[PAGE4],[PAGE5],[PAGE6],[PAGE7],[PAGE8],
[PAGE9][\r]
QSL,OK[\r]

```

```

[PAGE0] - [PAGE9] : ##### (each # is 0 - 2)
    0 : Not assigned (Displayed as "-" on the scanner.)
    1 : On           (Displayed as each number on the scanner.)
    2 : Off         (Displayed as "*" on the scanner.)
                The Order of Quick Key is as same as LCD Icon.
[PAGE0]          : Quick Key 1 - 9, 0
[PAGE1]          : Quick Key11 - 19,10
[PAGE2]          : Quick Key21 - 29,20
[PAGE3]          : Quick Key31 - 39,30

```



```

[PAGE4]           : Quick Key41 - 49,40
[PAGE5]           : Quick Key51 - 59,50
[PAGE6]           : Quick Key61 - 69,60
[PAGE7]           : Quick Key71 - 79,70
[PAGE8]           : Quick Key81 - 89,80
[PAGE9]           : Quick Key91 - 99,90

```

This command is only acceptable in Programming Mode.
It cannot turn on/off the Quick Key that has no System / Site.

```

<COMMAND QGL>
Get/Set Group Quick Lockout
Controller → Radio
QGL,[SYS_INDEX][\r]
QGL,[SYS_INDEX],#####[\r]
Radio → Controller
QGL,#####[\r]
QGL,OK[\r]

```

```

##### (each # is 0 - 2)      : Group Quick Key status of [SYS_INDEX].
      0 : Not assigned (Displayed as "-" on the scanner.)
      1 : On           (Displayed as each number on the scanner.)
      2 : Off          (Displayed as "*" on the scanner.)

```

The Order of Quick Key is as same as LCD Icon (1 - 9, 0).
This command is only acceptable in Programming Mode.
It cannot turn on/off the Quick Key that has no Group.

```

<COMMAND CSY>
Create System
Controller → Radio
CSY,[SYS_TYPE],[PROTECT][\r]
Radio → Controller
CSY,[SYS_INDEX][\r]

```

```

[SYS_TYPE] : System Type
      CNV      : CONVENTIONAL
      MOT      : MOTOROLA TYPE
      EDC      : EDACS Narrow / Wide
      EDS      : EDACS SCAT
      LTR      : LTR

```

```

[SYS_INDEX] : The Index of Created System
[PROTECT]   : Protect bit Status          (0:OFF / 1:ON)

```

Creates a system and return created system index.
The index is a handle to get/set system information.
Returns -1 if the scanner failed to create because of no resource.
This command is only acceptable in Programming Mode.

```

<COMMAND DSY>
Delete System
Controller → Radio
DSY,[SYS_INDEX][\r]
Radio → Controller
DSY,OK[\r]

```

[SYS_INDEX] : System Index

This command deletes a System.
This command is only acceptable in Programming Mode.

```

<COMMAND SIN>
Get/Set System Info

```

```

Controller → Radio
SIN,[INDEX][\r]
SIN,[INDEX],[NAME],[QUICK_KEY],[HLD],[LOUT],[DLY],[RSV],[RSV],[RSV],[RSV],
[RSV],[START_KEY],[RSV],[RSV],[RSV],[RSV],[RSV],[RSV],[NUMBER_TAG],
[RSV],[RSV],[RSV][\r]
Radio → Controller
SIN,[SYS_TYPE],[NAME],[QUICK_KEY],[HLD],[LOUT],[DLY],[RSV],[RSV],[RSV],[RSV],
[RSV],[REV_INDEX],[FWD_INDEX],[CHN_GRP_HEAD],[CHN_GRP_TAIL],[SEQ_NO],
[START_KEY],[RSV],[RSV],[RSV],[RSV],[RSV],[NUMBER_TAG],[RSV],
[RSV],[RSV],[PROTECT],[RSV][\r]
SIN,OK[\r]

```

```

[INDEX]           : System Index
[SYS_TYPE]        : System Type
    CNV           : CONVENTIONAL
    MOT           : MOTOROLA TYPE
    EDC           : EDACS Narrow / Wide
    EDS           : EDACS SCAT
    LTR           : LTR
[NAME]            : Name                (max.16char)
[QUICK_KEY]       : Quick Key           (0-99/(dot) means none)
[HLD]             : System Hold Time    (0-255)
[LOUT]           : Lockout              (0:Unlocked / 1:Lockout)
[DLY]            : Delay Time           (-10,-5,-2,0,1,2,5,10,30)
[REV_INDEX]       : Reverse System Index of the Scan Setting
[FWD_INDEX]       : Forward System Index of the Scan Setting
[CHN_GRP_HEAD]    : Channel Group Index Head of the conventional system or
Site Index Head of the Trunked System
[CHN_GRP_TAIL]    : Channel Group Index Tail of the conventional system or
Site Index Tail of the Trunked System
[SEQ_NO]          : System Sequence Number    (1 - 500)
[START_KEY]       : Startup Configuration Key (0-9/(dot) means none)
[NUMBER_TAG]      : Number tag             (0-999 / NONE)
[PROTECT]         : Protect bit Status      (0:OFF / 1:ON)
[RSV]             : Reserve Parameter      * This is always only ",".

```

Get/Set System Information.

The scanner returns only ",," to punctuate for parameters which are not appropriate the system type.

In set command, the scanner neglects the parameters that are not appropriate the system type.

In set command, only ",," parameters are not changed.

The set command is aborted if any format error is detected.

This command is only acceptable in Programming Mode.

When the system protect bit is ON, except [SYS_TYPE], [NAME], [REV_INDEX], [FWD_INDEX], [CHN_GRP_HEAD], [CHN_GRP_TAIL], other parameters will be send as a reserve parameter in the Radio -> Controller command.

```

<COMMAND TRN>
Get/Set Trunk Info
Controller → Radio
TRN,[INDEX]\r
TRN,[INDEX],[ID_SEARCH],[S_BIT],[END_CODE],[AFS],[RSV],[RSV],[EMG],[EMGL],
[FMAP],[CTM_FMAP],[RSV],[RSV],[RSV],[RSV],[RSV],[RSV],[RSV],[RSV],[RSV],
[RSV],[MOT_ID],[RSV],[EMG_PATTERN],[RSV],[PRI_ID_SCAN]\r
Radio → Controller
TRN,[ID_SEARCH],[S_BIT],[END_CODE],[AFS],[RSV],[RSV],[EMG],[EMGL],[FMAP],
[CTM_FMAP],[RSV],[RSV],[RSV],[RSV],[RSV],[RSV],[RSV],[RSV],[RSV],[RSV],
[TGID_GRP_HEAD],[TGID_GRP_TAIL],[ID_LOUT_GRP_HEAD],[ID_LOUT_GRP_TAIL],
[MOT_ID],[RSV],[EMG_PATTERN],[RSV],[PRI_ID_SCAN]\r
TRN,OK\r

```

```

[INDEX]      : System Index
[ID_SEARCH]  : ID Search/Scan (0:ID Scan mode / 1: Search Mode)
[S_BIT]     : Motorola Status Bit (0:Ignore, 1:Yes)
[END_CODE]  : Motorola End Code(0:Ignore,1:Yes)
[AFS]       : EDACS ID Format (0:Decimal / 1:AFS)
[EMG]       : Emergency Alert (0:Ignore / 1-9:Alert)
[EMGL]      : Emergency Alert Level (0:OFF / 1 - 15)
[FMAP]      : Fleet Map (0-16, 0-15:Preset, 16:Custom)
[CTM_FMAP]  : Custom Fleet Map Setting (##### : # is 0-E)
              # means Size Code of each BLOCK (from 0 to 7)
              0 : Size Code 0   5 : Size Code 5   A : Size Code 10
              1 : Size Code 1   6 : Size Code 6   B : Size Code 11
              2 : Size Code 2   7 : Size Code 7   C : Size Code 12
              3 : Size Code 3   8 : Size Code 8   D : Size Code 13
              4 : Size Code 4   9 : Size Code 9   E : Size Code 14
[TGID_GRP_HEAD] : TGID Index Head of the System
[TGID_GRP_TAIL] : TGID Index Tail of the System
[ID_LOUT_GRP_HEAD]: L/O TGID Group Index Head of the System
[ID_LOUT_GRP_TAIL]: L/O TGID Group Index Tail of the System
[MOT_ID]       : Motorola ID Format (0:Decimal / 1:HEX )
[EMG_PATTERN]  : Emergency Alert Light Pattern(0:ON/1:Slow /2:Fast)
[PRI_ID_SCAN]  : Priority ID Scan ( 0:OFF / 1: ON)
[RSV]         : Reserve Parameter * This is always only ",,".

```

Get/Sets Trunked System Information.

The scanner returns only "," to punctuate for parameters which are not appropriate the system type.
 In set command, the scanner neglects the parameters that are not appropriate the system.
 In set command, only "," parameters are not changed.
 The set command is aborted if any format error is detected.
 When the system protect bit is ON, except [TGID_GRP_HEAD], [TGID_GRP_TAIL], [ID_LOUT_GRP_HEAD], [ID_LOUT_GRP_TAIL], other parameters will be send as a reserve parameter in the Radio -> Controller command.
 This command is only acceptable in Programming Mode.

```
<COMMAND AST>
Append Site
Controller → Radio
AST,[SYS_INDEX],[RSV][\r]
Radio → Controller
AST,[SITE_INDEX][\r]
```

```
[SYS_INDEX]           : System Index
[SITE_INDEX]          : Appended Site Index
```

Append Site to the system.
 Returns "-1" if the scanner failed to create because of no resource.
 This command is only acceptable in Programming Mode.

```
<COMMAND SIF>
Get/Set Site Info
Controller → Radio
SIF,[INDEX][\r]
SIF,[INDEX],[NAME],[QUICK_KEY],[HLD],[LOUT],[MOD],[ATT],[C-CH],[RSV],[RSV],
[START_KEY],[LATITUDE],[LONGITUDE],[RANGE],[GPS_ENABLE],[RSV],[MOT_TYPE],
[EDACS_TYPE],[RSV],[RSV][\r]
Radio → Controller
SIF,[RSV],[NAME],[QUICK_KEY],[HLD],[LOUT],[MOD],[ATT],[C-CH],[RSV],[RSV],
[REV_INDEX],[FWD_INDEX],[SYS_INDEX],[CHN_HEAD],[CHN_TAIL],[SEQ_NO],
[START_KEY],[LATITUDE],[LONGITUDE],[RANGE],[GPS_ENABLE],[RSV],[MOT_TYPE],
[EDACS_TYPE],[RSV],[RSV][\r]
SIF,OK[\r]
```

```
[INDEX]           : Site Index
[NAME]            : Name (max.16char)
[QUICK_KEY]       : Quick Key (0-99/.(dot) means none)
[HLD]             : Site Hold Time (0-255)
[LOUT]           : Lockout (0:Unlocked / 1:Lockout)
[MOD]            : Modulation (AUTO/FM/NFM)
[ATT]            : Attenuation (0:OFF/1:ON)
[C-CH]           : Control Channel Only (0:OFF / 1:ON)
[REV_INDEX]      : Reverse Site Index of the Scan Setting
[FWD_INDEX]      : Forward Site Index of the Scan Setting
```

```

[SYS_INDEX]      : System Index
[CHN_HEAD]      : Channel Index Head of the Group List
[CHN_TAIL]      : Channel Index Tail of the Group List
[SEQ_NO]        : Site Sequence Number (1-256)
[START_KEY]     : Startup Configuration (0-9/.(dot) means none)
[LATITUDE]      : North or South Latitude
[LONGITUDE]     : West or East Longitude
[RANGE]         : Range (1-250 : 1= 0.5 mile or km)
[GPS_ENABLE]    : GPS Location detection (0:OFF/1:ON)
[MOT_TYPE]      : Band type for MOT/EDACS(STD/ SPL/CUSTOM)
[EDACS_TYPE]    : EDACS (WIDE/NARROW)
[RSV]           : Reserve Parameter * This is always only ",".

```

Get/Set Site Information.

The scanner returns only ",," to punctuate for parameters which are not appropriate the site type.

In set command, the scanner neglects the parameters that are not appropriate the system type.

In set command, only ",," parameters are not changed.

The set command is aborted if any format error is detected.

When the system protect bit is ON, except [REV_INDEX], [FWD_INDEX], [SYS_INDEX], [CHN_HEAD], [CHN_TAIL], other parameters will be send as a reserve parameter in the Radio -> Controller command.

This command is only acceptable in Programming Mode.

<COMMAND MCP>

Get/Set Motorola Custom Band Plan

Controller → Radio

MCP, [INDEX] [\r]

MCP, [INDEX], [LOWER1], [UPPER1], [STEP1], [OFFSET1], [LOWER2], [UPPER2], [STEP2], [OFFSET2], [LOWER3], [UPPER3], [STEP3], [OFFSET3], [LOWER4], [UPPER4], [STEP4], [OFFSET4], [LOWER5], [UPPER5], [STEP5], [OFFSET5], [LOWER6], [UPPER6], [STEP6], [OFFSET6] [\r],

Radio → Controller

MCP, [LOWER1], [UPPER1], [STEP1], [OFFSET1], [LOWER2], [UPPER2], [STEP2], [OFFSET2], [LOWER3], [UPPER3], [STEP3], [OFFSET3], [LOWER4], [UPPER4], [STEP4], [OFFSET4], [LOWER5], [UPPER5], [STEP5], [OFFSET5], [LOWER6], [UPPER6], [STEP6], [OFFSET6] [\r],

MCP, OK [\r]

```

[INDEX]      : Site Index
[LOWER n]    : Lower Frequency n
[UPPER n]    : Upper Frequency n
[STEP n]     : Step n
              "500": 5.0k      "625": 6.25k    "1000": 10.0k
              "1250": 12.5k    "1500": 15.0k   "1875": 18.75k
              "2000": 20.0k    "2500": 25.0k   "3000": 30.0k
              "3125": 31.25k   "3500": 35.0k   "3750": 37.5k
              "4000": 40.0k    "4375": 43.75k  "4500": 45.0k
              "5000": 50.0k    "5500": 55.0k   "5625": 56.25k
              "6000": 60.0k    "6250": 62.5k   "6500": 65.0k

```

"6875": 68.75k	"7000": 70.0k	"7500": 75.0k
"8000": 80.0k	"8125": 81.25k	"8500": 85.0k
"8750": 87.5k	"9000": 90.0k	"9375": 93.75k
"9500": 95.0k	"10000": 100.0k	

[OFFSETn] : Offset n (-1023 to 1023)

Get/Sets Band Plan Setting for MOT 800 custom/VHF/UHF site.

In set command, if only "," parameters are send the Band Plan setting of the site will not changed.

The set command is aborted if any format error is detected.

When the system protect bit is ON, all the parameters will be send as a reserve parameter in the Radio -> Controller command.

Before using this command, user should set Band Plan type as "Custom" first by using SIF command.

This command is only acceptable in Programming Mode.

<COMMAND TFQ>

Get/Set Trunk Frequency Info

Controller → Radio

TFQ, [CHN_INDEX] [\r]

TFQ, [CHN_INDEX], [FRQ], [LCN], [LOUT], [RSV], [NUMBER_TAG], [VOL_OFFSET], [RSV] [\r]

Radio → Controller

TFQ, [FRQ], [LCN], [LOUT], [REV_INDEX], [FWD_INDEX], [SYS_INDEX], [GRP_INDEX], [RSV], [NUMBER_TAG], [VOL_OFFSET], [RSV] [\r]

TFQ,OK[\r]

[CHN_INDEX]	: Trunk Frequency Index
[FRQ]	: Trunk Frequency
[LCN]	: LCN (EDACS WIDE/NARROW system: 0 to 20 LTR system: 0 to 30)
[LOUT]	: Lockout (0:Unlocked / 1:Lockout)
[REV_INDEX]	: Reverse Frequency Index of the Site
[FWD_INDEX]	: Forward Frequency Index of the Site
[SYS_INDEX]	: System Index of the Frequency
[GRP_INDEX]	: Index of the Site
[NUMBER_TAG]	: Number tag (0-999 / NONE)
[VOL_OFFSET]	: Volume Offset (-3 - +3)

In set command, only "," parameters are not changed.

The set command is aborted if any format error is detected.

This command is only acceptable in Programming Mode.

For Motorola or EDACS SCAT System, [LCN] is ignored.

When the system protect bit is ON, except [REV_INDEX], [FWD_INDEX], [SYS_INDEX], [GRP_INDEX], other parameters will be send as a reserve parameter in the Radio -> Controller command.

[NUMBER_TAG] and [VOL_OFFSET] are just used for SCAT system.

```
<COMMAND AGC>
Append Channel Group
Controller → Radio
AGC, [SYS_INDEX] [\r]
Radio → Controller
AGC, [GRP_INDEX] [\r]
```

```
[SYS_INDEX] : System Index
[GRP_INDEX] : appended Channel Group Index
```

Append Channel Group to the system.
Returns "-1" if the scanner failed to create because of no resource.
This command is only acceptable in Programming Mode.

```
<COMMAND AGT>
Append TGID Group
Controller → Radio
AGT, [SYS_INDEX] [\r]
Radio → Controller
AGT, [GRP_INDEX] [\r]
```

```
[SYS_INDEX] : System Index
[GRP_INDEX] : appended TGID Group Index
```

Append TGID Group to the system.
Returns "-1" if the scanner failed to create because of no resource.
This command is only acceptable in Programming Mode.

```
<COMMAND DGR>
Delete Group / Site
Controller → Radio
DGR, [INDEX] [\r]
Radio → Controller
DGR, OK [\r]
```

```
[INDEX] : Group / Site Index
```

This command deletes a Channel Group, TGID Group or Site.
This command is only acceptable in Programming Mode.

```

<COMMAND GIN>
Get/Set Group Info
Controller → Radio
GIN, [GRP_INDEX] [\r]
GIN, [GRP_INDEX], [NAME], [QUICK_KEY], [LOUT], [LATITUDE], [LONGITUDE], [RANGE],
[GPS ENABLE] [\r]
Radio → Controller
GIN, [GRP_TYPE], [NAME], [QUICK_KEY], [LOUT], [REV_INDEX], [FWD_INDEX], [SYS_INDEX],
[CHN_HEAD], [CHN_TAIL], [SEQ_NO] , [LATITUDE], [LONGITUDE], [RANGE], [GPS ENABLE] [\r]
GIN, OK [\r]

```

For Group Information

```

[GRP_INDEX]      : Group Index
[GRP_TYPE]       : Group Type          (C: Channel Group / T: TGID Group)
[NAME]           : Name                  (max.16char)
[QUICK_KEY]      : Quick Key (1-9,0: means 10, .(dot): means none)
[LOUT]           : Lockout              (0:Unlocked / 1:Lockout)
[REV_INDEX]      : Reverse Group Index of the System
[FWD_INDEX]      : Forward Group Index of the System
[SYS_INDEX]      : System Index
[CHN_HEAD]       : Channel Index Head of the Group List
[CHN_TAIL]       : Channel Index Tail of the Group List
[SEQ_NO]         : Group Sequence Number of the System
[LATITUDE]       : North or South Latitude
[LONGITUDE]      : West or East Longitude
[RANGE]          : Range                  (1-250 : 1= 0.5 mile or km)
[GPS ENABLE]     : GPS Location detection (0:OFF/1:ON)

```

Get/Set Group Information.

In set command, only ", " parameters are not changed.

The set command is aborted if any format error is detected.

When the system protect bit is ON, except [NAME], [REV_INDEX], [FWD_INDEX], [SYS_INDEX], [CHN_HEAD], [CHN_TAIL], other parameters will be send as a reserve parameter in the Radio -> Controller command.

This command is only acceptable in Programming Mode.

```
<COMMAND ACC>
Append Channel / Trunk Frequency
Controller → Radio
ACC, [GRP_INDEX] [\r]
Radio → Controller
ACC, [CHN_INDEX] [\r]
```

```
[GRP_INDEX] : Channel Group Index
[CHN_INDEX] : Appended Channel Index
```

- or -

```
[GRP_INDEX] : Site Index
[CHN_INDEX] : Appended Trunk Frequency Index
```

Append Channel to the group. Or, append Trunk Frequency to the Site. Returns "-1" if the scanner failed to create because of no resource. This command is only acceptable in Programming Mode.

```
<COMMAND ACT>
Append TGID
Controller → Radio
ACT, [GRP_INDEX] [\r]
Radio → Controller
ACT, [INDEX] [\r]
```

```
[GRP_INDEX] : TGID Group Index
[TGID_INDEX] : appended TGID Index
```

Append TGID to the group. Returns "-1" if the scanner failed to create because of no resource. This command is only acceptable in Programming Mode.

```
<COMMAND DCH>
Delete Channel
Controller → Radio
DCH, [INDEX] [\r]
Radio → Controller
DCH,OK[\r]
```

```
[INDEX] : Channel Index, TGID Index or Trunked Frequency Index
```

This command deletes a Channel and TGID. This command is also valid for deleting a Trunk Frequency. This command is only acceptable in Programming Mode.

```

<COMMAND CIN>
Get/Set Channel Info
Controller → Radio
CIN, [INDEX] [\r]
CIN, [INDEX], [NAME], [FRQ], [MOD], [CTCSS/DCS], [TLOCK], [LOUT], [PRI], [ATT], [ALT],
[ALTL], [RSV], [RSV], [RSV], [NUMBER_TAG], [RSV], [ALT_PATTERN],
[VOL_OFFSET] [\r]
Radio → Controller
CIN, [NAME], [FRQ], [MOD], [CTCSS/DCS], [TLOCK], [LOUT], [PRI], [ATT], [ALT], [ALTL],
[REV_INDEX], [FWD_INDEX], [SYS_INDEX], [GRP_INDEX], [RSV], [RSV], [RSV],
[NUMBER_TAG], [RSV], [ALT_PATTERN], [VOL_OFFSET] [\r]
CIN,OK[\r]

```

```

[INDEX]           : Channel Index
[NAME]            : Name (max.16char)
[FRQ]             : Channel Frequency
[MOD]             : Modulation      (AUTO/AM/FM/NFM/WFM/FMB)
[ATT]             : Attenuation      (0:OFF / 1:ON)
[CTCSS/DCS]      : CTCSS/DCS Status  (0-231 )
                  *See CTCSS/DCS CODE LIST about the details of this code.
[TLOCK]          : CTCSS/DCS Tone Lockout(0:OFF / 1:ON)
[LOUT]           : Lockout           (0:Unlocked / 1:Lockout)
[PRI]            : Priority           (0:OFF / 1:ON)
[ALT]            : Alert Tone        (0:OFF / 1-9:Tone No)
[ALTL]           : Alert Tone Level  (0:AUTO/ 1-15)
[REV_INDEX]      : Reverse Channel Index of the Chan0nel Group
[FWD_INDEX]      : Forward Channel Index of the Channel Group
[SYS_INDEX]      : System Index of the Channel
[GRP_INDEX]      : Group Index of the Channel
[NUMBER_TAG]     : Number tag        (0-999 / NONE)
[ALT_PATTERN]    : Alert Light Pattern(0:ON / 1:SLow / 2:Fast)
[VOL_OFFSET]     : Volume Offset     (-3 - +3)

```

Get/Set Channel Information.

In set command, only ", " parameters are not changed.

The set command is aborted if any format error is detected.

This command is only acceptable in Programming Mode.

When the system protect bit is ON, except [REV_INDEX], [FWD_INDEX], [SYS_INDEX], [GRP_INDEX], other parameters will be send as a reserve parameter in the Radio - > Controller command.

```

<COMMAND TIN>
Get/Set TGID Info
Controller → Radio
TIN,[INDEX][\r]
TIN,[INDEX],[NAME],[TGID],[LOUT],[PRI],[ALT],[ALTL],[RSV],[RSV],
[NUMBER_TAG],[RSV],[ALT_PATTERN],[VOL_OFFSET][\r]
Radio → Controller
TIN,[NAME],[TGID],[LOUT],[PRI],[ALT],[ALTL],[REV_INDEX],[FWD_INDEX],
[SYS_INDEX],[GRP_INDEX],[RSV],[RSV],[NUMBER_TAG],[RSV],
[ALT_PATTERN],[VOL_OFFSET][\r]
TIN,OK[\r]

```

```

[INDEX]           : TGID Index
[NAME]            : Name (max.16char)
[TGID]            : TGID
[LOUT]            : Lockout                (0:Unlocked / 1:Lockout)
[PRI]             : Priority                (0:OFF / 1:ON)
[ALT]             : Alert Tone             (0:OFF / 1-9:Tone No)
[ALTL]            : Alert Tone Level       (0:AUTO/ 1-15)
[REV_INDEX]       : Reverse TGID Index of the Group
[FWD_INDEX]       : Forward TGID Index of the Group
[SYS_INDEX]       : System Index of the TGID
[GRP_INDEX]       : Group Index of the TGID
[NUMBER_TAG]      : Number tag             (0-999 / NONE)
[ALT_PATTERN]     : Alert Light Pattern(0:ON / 1:SLow / 2:Fast)
[VOL_OFFSET]      : Volume Offset          (-3 - +3)

```

Get/Set TGID Information.

In set command, only ", " parameters are not changed.

The set command is aborted if any format error is detected.

This command is only acceptable in Programming Mode.

When the system protect bit is ON, except [REV_INDEX], [FWD_INDEX], [SYS_INDEX], [GRP_INDEX], other parameters will be send as a reserve parameter in the Radio -> Controller command.

```

<COMMAND GLI>
Get Lockout TGID (for Rvw L/O ID)
Controller → Radio
GLI,[SYS_INDEX][\r]
Radio → Controller
GLI,[TGID][\r]
GLI,-1[\r]           : No more lockout TGID

```

This command is used to get L/O TGID list of a system.

You should call this command again and again to get all L/O TGID until the scanner returns "-1".

"-1" means that no more L/O TGID exists.

When the system protect bit is ON, only "-1" will be send in the Radio -> Controller command.

This command is only acceptable in Programming Mode.

```
<COMMAND SLI>
Get Search L/O TGID
Controller → Radio
SLI,[SYS_INDEX][\r]
Radio → Controller
SLI,[TGID][\r]
SLI,-1[\r]           : No more lockout TGID
```

This command is used to get Search L/O TGID list of the system.
Search L/O TGID is the L/O TGID which doesn't belong to any group in the system as a TGID.

Compared with GLI command, this command doesn't return any L/O TGID which is belong to one of group in the system.

You should call this command again and again to get all L/O TGID until the scanner returns "-1".

"-1" means that no more L/O TGID exists.

This command is only acceptable in Programming Mode.

```
<COMMAND ULI>
Unlock TGID (for Rvw L/O ID)
Controller → Radio
ULI,[SYS_INDEX],[TGID][\r]
Radio → Controller
ULI,OK[\r]
```

This command unlocks a L/O TGID in a system.

The TGID is deleted from L/O list.

This command is only acceptable in Programming Mode.

```
<COMMAND LOI>
Lockout ID (TGID)
Controller → Radio
LOI,[SYS_INDEX],[TGID][\r]
Radio → Controller
LOI,OK[\r]
```

This command locks out a TGID for the system.

The TGID is added to L/O list.

This command is only acceptable in Programming Mode.

<COMMAND REV>
Get Rev Index
Controller → Radio
REV, [INDEX] [\r]
Radio → Controller
REV, [INDEX] [\r]

[INDEX] : Index of system, site, group, channel, TGID or
Location Alert System.

Returns reverse(backward) index of the index in the memory chain.

Returns -1 if no more index exists.

This command is only acceptable in Programming Mode.

<COMMAND FWD>
Get Fwd Index
Controller → Radio
FWD, [INDEX] [\r]
Radio → Controller
FWD, [INDEX] [\r]

[INDEX] : Index of system, site, group, channel, TGID or
Location Alert System.

Returns forward index of the index in the memory chain.

Returns -1 if no more index exists.

This command is only acceptable in Programming Mode.

<COMMAND RMB>
Get Remains of Memory Block
Controller → Radio
RMB [\r]
Radio → Controller
RMB, ##### [\r]

Returns the number of idle(free) memory block.

: ##### (not zero-padding)

This command is only acceptable in Programming Mode.

```

<COMMAND MEM>
Get Memory Used
Controller → Radio
MEM[\r]
Radio → Controller
MEM, [MEMORY_USED], [SYS], [SITE], [CHN], [LOC] [\r]

[MEMORY_USED] : The percent of memory that is used      (0 - 100)
[SYS]          : The number of systems that is created   (0 - 500)
[SITE]         : The number of sites that is created     (0 - 1000)
[CHN]          : The number of channels that is created  (0 - 9000)
[LOC]          : The number of location system that is created (0 - 1000)

```

This command is only acceptable in Programming Mode.

```

<COMMAND LIH>
Get Location Alert System Index Head
Controller → Radio
LIH, [LAS_TYPE] [\r]
Radio → Controller
LIH, [INDEX] [\r]

[LAS_TYPE]      : Location Alert Type
                 (POI:POI / DROAD: Dangerous Road / DXING : Dangerous Xing)

```

Returns the first index of stored location alert system list.
This command is only acceptable in Programming Mode.

```

<COMMAND LIT>
Get Location Alert System Index Tail
Controller → Radio
LIT, [LAS_TYPE] [\r]
Radio → Controller
LIT, [INDEX] [\r]

[LAS_TYPE]      : Location Alert Type
                 (POI:POI / DROAD: Dangerous Road / DXING : Dangerous Xing)

```

Returns the last index of stored location alert system list.
This command is only acceptable in Programming Mode.

```
<COMMAND CLA>
Create Location Alert System
Controller → Radio
CLA, [LAS_TYPE] [\r]
Radio → Controller
CLA, [INDEX] [\r]
```

```
[LAS_TYPE]          : Location Alert Type
                    (POI: POI / DROAD: Dangerous Road / DXING: Dangerous Xing)
[INDEX]             : Location Alert System Index
```

Creates a system and return created location alert system index.
The index is a handle to get/set location alert system information.
Returns "-1" if the scanner failed to create because of no resource.
This command is only acceptable in Programming Mode.

```
<COMMAND DLA>
Delete Location Alert System
Controller → Radio
DLA, [INDEX] [\r]
Radio → Controller
DLA, OK [\r]
```

```
[INDEX]             : Location Alert System Index
```

This command deletes a location alert system.
This command is only acceptable in Programming Mode.

```

<COMMAND LIN>
Get/Set Location Alert System Info
Controller → Radio
LIN, [INDEX] [\r]
LIN, [INDEX], [LAS_TYPE], [NAME], [LOUT], [ALT], [ALTL], [LATITUDE], [LONGITUDE],
[RANGE], [SPEED], [DIR], [RSV], [ALT_PATTERN] [\r]
Radio → Controller
LIN, [LAS_TYPE], [NAME], [LOUT], [ALT], [ALTL], [REV_INDEX], [FWD_INDEX], [SEQ_NO],
[LATITUDE], [LONGITUDE], [RANGE], [SPEED], [DIR], [RSV], [ALT_PATTERN] [\r]
LIN, OK [\r]

```

```

[INDEX]           : Location Alert System Index
[LAS_TYPE]        : Location Alert Type
                   (POI: POI / DROAD: Dangerous Road / DXING: Dangerous Xing)
[NAME]            : Name                (max.16char)
[LOUT]            : Lockout              (0:Unlocked / 1:Lockout)
[ALT]             : Alert Tone           (0:OFF/1 - 4:Tone No.)
[ALTL]           : Alert Tone Level     (0:AUTO/1-15)
[REV_INDEX]       : Reverse System Index of Location Alert System
[FWD_INDEX]       : Forward System Index of Location Alert System
[SEQ_NO]          : Location Alert System Sequence Number
[LATITUDE]        : North or South Latitude
[LONGITUDE]       : West or East Longitude
[RANGE]           : Range                (1-80: 1=0.05 mile or km)
[SPEED]           : Speed Limit         (0-200: 1 means 1 mile/hour or km/h)
[DIR]             : Heading             (0-358/360 : 2' step, 360=All range)
[ALT_PATTERN]     : Alert Light Pattern(0:ON / 1:SLow / 2:Fast)

```

Get/Set Location Alert System Information.

In set command, the scanner neglects the parameters that are not appropriate the system type.

In set command, only ", " parameters are not changed.

The set command is aborted if any format error is detected.

This command is only acceptable in Programming Mode.

```

<COMMAND SCO>
Get/Set Search/Close Call Settings
Controller → Radio
SCO[\r]
SCO, [RSV], [MOD], [ATT], [DLY], [RSV], [CODE_SRCH], [BSC], [REP], [RSV], [RSV],
[ MAX_STORE], [RSV], [RSV], [RSV], [RSV] [\r]
Radio → Controller
SCO, [RSV], [MOD], [ATT], [DLY], [RSV], [CODE_SRCH], [BSC], [REP], [RSV], [RSV],
[ MAX_STORE], [RSV], [RSV], [RSV], [RSV] [\r]
SCO,OK[\r]

```

```

[MOD]      : Modulation          (AUTO/AM/FM/NFM/WFM/FMB)
[ATT]      : Attenuation         (0:OFF / 1:ON)
[DLY]      : Delay Time         (-10,-5,-2,0,1,2,5,10,30)
[CODE_SRCH]: CTCSS/DCS Search
              (0:OFF / 1: CTCSS/DCS Search)
[BSC]      : Broadcast Screen   (16digit: #####*#)
              (each # is 0 or 1)   |||||||*+ Band10
              0 means OFF         |||||||      :
              1 means ON         |||||+----- Band 2
                                   |||||+----- Band 1
                                   |||||+----- Reserve
                                   |||+----- NOAA WX
                                   ||+----- VHF TV
                                   |+----- UHF TV
                                   +----- FM
                                   +----- Pager
[REP]      : Repeater Find      (0:OFF / 1:ON)
[ MAX_STORE]: Max Auto Store    (1-256)

```

Get/Set Search/Close Call Settings.
 In set command, only ", " parameters are not changed.
 The set command is aborted if any format error is detected.
 This command is only acceptable in Programming Mode.

```

<COMMAND BBS>
Get/Set Broadcast Screen Band Settings
Controller → Radio
BBS, [INDEX] [\r]
BBS, [INDEX], [LIMIT_L], [LIMIT_H] [\r]
Radio → Controller
BBS, [LIMIT_L], [LIMIT_H] [\r]
BBS,OK[\r]

```

```

[INDEX]    : Index              (1-9,0 means 10)
[LIMIT_L]  : Lower Limit Frequency (00000000 -99999999)
[LIMIT_H]  : Upper Limit Frequency (00000000 -99999999)

```

Get/Set Broadcast Screen Band Settings. This command is only acceptable in Programming Mode.

```

<COMMAND SHK>
Get/Set Search Key Settings
Controller → Radio
SHK[\r]
SHK,[SRCH_KEY_1],[SRCH_KEY_2],[SRCH_KEY_3],[RSV],[RSV],[RSV][\r]
Radio → Controller
SHK,[SRCH_KEY_1],[SRCH_KEY_2],[SRCH_KEY_3],[RSV],[RSV],[RSV][\r],SHK,OK[\r]

```

```

[SRCH_KEY_1] - [SRCH_KEY_3] : Search Range
.(dot) : Not assign
PublicSafety: Public Safety range CUSTOM_1: Custom 1 range
News : News range CUSTOM_2: Custom 2 range
HAM : HAM Radio range CUSTOM_3: Custom 3 range
Marine : Marine range CUSTOM_4: Custom 4 range
Railroad : Railroad range CUSTOM_5: Custom 5 range
Air : Air range CUSTOM_6: Custom 6 range
CB : CB Radio range CUSTOM_7: Custom 7 range
FRS/GMRS/MURS: FRS/GMRS/MURS range CUSTOM_8: Custom 8 range
Racing : Racing range CUSTOM_9: Custom 9 range
FM : FM Broadcast range CUSTOM_10: Custom 10 range
Special : Special range TONE_OUT: Tone Out mode

```

Get/Set Search Key Settings.
This command is only acceptable in Programming Mode.

```

<COMMAND GLF>
Get Global Lockout Freq
Controller → Radio
GLF[\r]
Radio → Controller
GLF,[FRQ][\r]
GLF,-1[\r]

```

```

[FRQ] : Lockout Frequency (250000-13000000)

```

This command is used to get Global L/O frequency list.
You should call this command again and again to get all-global L/O frequency until the scanner returns "-1".
"-1" means that no more L/O frequency exists.
This command is only acceptable in Programming Mode.

```
<COMMAND ULF>
Unlock Global L/O
Controller → Radio
ULF,[FRQ][\r]
Radio → Controller
ULF,OK[\r]
```

[FRQ] : Lockout Frequency (250000-13000000)

This command unlocks a L/O frequency.
The frequency is deleted from L/O list.
This command is only acceptable in Programming Mode.

```
<COMMAND LOF >
Lock Out Frequency
Controller → Radio
LOF,[FRQ][\r]
Radio → Controller
LOF,OK[\r]
```

[FRQ] : Frequency (250000-13000000)

This command locks out a frequency.
The frequency is added to L/O list.
This command is only acceptable in Programming Mode.

```

<COMMAND CLC>
Get/Set Close Call Settings
Controller → Radio
CLC[\r]
CLC,[CC_MODE],[CC_OVERRIDE],[RSV],[ALTB],[ALTL],[ALTP],[CC_BAND],[LOUT],
[HLD],[QUICK_KEY],[NUMBER_TAG],[RSV],[ALT_PATTERN][\r]
Radio → Controller
CLC,[CC_MODE],[CC_OVERRIDE],[RSV],[ALTB],[ALTL],[ALTP],[CC_BAND],[LOUT],
[HLD],[QUICK_KEY],[NUMBER_TAG],[RSV],[ALT_PATTERN][\r]
CLC,OK[\r]

```

```

[CC_MODE]           : Mode           ( 0:OFF / 1:CC PRI / 2:CC DND)
[CC_OVERRIDE]      : Override         (1:ON / 0:OFF)
[ALTB]             : Alert Beep      (0:OFF / 1-9:Tone No)
[ALTL]            : Alert Tone Level  (0:AUTO/ 1-15)
[ALTP]            : Close Call Pause
                   3      : 3 sec          5      : 5 sec
                   10     : 10 sec         15     : 15 sec
                   30     : 30 sec         45     : 45 sec
                   60     : 60 sec         INF    : Infinite
[CC_BAND]         : Close Call Band   (7digit ##### )
                   (each # is 0 or 1)  |||||+- 800MHz+
                   0 means OFF         ||||+--- UHF
                   1 means ON         |||+---- Reserve
                                       ||+----- VHF HIGH
                                       |+----- AIR BAND
                                       |+----- VHF LOW2
                                       +----- VHF LOW1
[LOUT]           : Lockout for CC Hits with Scan(0:Unlocked/1:Lockout)
[HLD]            : System Hold Time for CC Hits with Scan (0-255)
[QUICK_KEY]      : Quick Key for CC Hits with Scan (0 - 99/.(dot) )
                   *".(dot)" means that nothing is assigned.
[NUMBER_TAG]     : Number tag         (0-999 / NONE)
[ALT_PATTERN]    : Alert Light Pattern(0:ON / 1:Slow / 2:Fast)
[RSV]            : Reserve Parameter  * This is always only ",".

```

Get/Set Close Call Settings.
 In set command, only ", " parameters are not changed.
 The set command is aborted if any format error is detected.
 This command is only acceptable in Programming Mode.

<COMMAND SSP>

Get/Set Service Search Settings

Controller → Radio

SSP,[SRCH_INDEX][\r]

SSP,[SRCH_INDEX],[DLY],[ATT],[HLD],[LOUT],[QUICK_KEY],[START_KEY],[RSV],[NUMBER_TAG],[RSV],[RSV],[RSV][\r]

Radio → Controller

SSP,[SRCH_INDEX],[DLY],[ATT],[HLD],[LOUT],[QUICK_KEY],[START_KEY],[RSV],[NUMBER_TAG],[RSV],[RSV],[RSV][\r]

SSP,OK[\r]

[SRCH_INDEX]	: Service Search Range		
	1 : Public Safety	6 : Air	12 : Special
	2 : News	7 : CB Radio	
	3 : HAM Radio	8 : FRS/GMRS/MURS	
	4 : Marine	9 : Racing	
	5 : Railroad	11 : FM Broadcast	
[DLY]	: Delay Time	(-10,-5,-2,0,1,2,5,10,30)	
[ATT]	: Attenuation	(0:OFF/1:ON)	
[HLD]	: System Hold Time for Search with Scan	(0-255)	
[LOUT]	: Lockout for Search with Scan	(0:Unlocked/1:Lockout)	
[QUICK_KEY]	: Quick Key	(0 - 99 / .(dot))	
[START_KEY]	: Startup Configuration Key	(0 - 9 / .(dot))	
[NUMBER_TAG]	: Number tag	(0-999 / NONE)	

The set command is aborted if any format error is detected.

This command is only acceptable in Programming Mode.

<COMMAND CSG>

Get/Set Custom Search Group

Controller → Radio

CSG[\r]

CSG,#####[\r] : Status of Each Search Range

Radio → Controller

CSG,#####[\r]

CSG,OK[\r]

(each # is 0 or 1) : 0 : valid / 1 : invalid

The Order of Range is as same as LCD Icon (1 - 10).

Get/Set current status of the custom search range.

This command is only acceptable in Programming Mode.

*It can not set all Custom Search Ranges to "0".

<COMMAND CBP>

Get/Set C-Ch Only Custom Search MOT Band Plan Settings

Controller → Radio

CBP, [SRCH_INDEX] [\r]

CBP, [SRCH_INDEX], [MOT_TYPE], [LOWER1], [UPPER1], [STEP1], [OFFSET1], [LOWER2], [UPPER2], [STEP2], [OFFSET2], [LOWER3], [UPPER3], [STEP3], [OFFSET3], [LOWER4], [UPPER4], [STEP4], [OFFSET4], [LOWER5], [UPPER5], [STEP5], [OFFSET5], [LOWER6], [UPPER6], [STEP6], [OFFSET6] [\r],

Radio → Controller

CBP, [MOT_TYPE], [LOWER1], [UPPER1], [STEP1], [OFFSET1], [LOWER2], [UPPER2], [STEP2], [OFFSET2], [LOWER3], [UPPER3], [STEP3], [OFFSET3], [LOWER4], [UPPER4], [STEP4], [OFFSET4], [LOWER5], [UPPER5], [STEP5], [OFFSET5], [LOWER6], [UPPER6], [STEP6], [OFFSET6] [\r],

CBP, OK [\r]

[SRCH_INDEX] : Index (1-9,0 means 10)
[MOT_TYPE] : Band type for MOT(STD/ SPL/CUSTOM)
[LOWER n] : Lower Frequency n
[UPPER n] : Upper Frequency n
[STEP n] : Step n
"500": 5.0k "625": 6.25k "1000": 10.0k
"1250": 12.5k "1500": 15.0k "1875": 18.75k
"2000": 20.0k "2500": 25.0k "3000": 30.0k
"3125": 31.25k "3500": 35.0k "3750": 37.5k
"4000": 40.0k "4375": 43.75k "4500": 45.0k
"5000": 50.0k "5500": 55.0k "5625": 56.25k
"6000": 60.0k "6250": 62.5k "6500": 65.0k
"6875": 68.75k "7000": 70.0k "7500": 75.0k
"8000": 80.0k "8125": 81.25k "8500": 85.0k
"8750": 87.5k "9000": 90.0k "9375": 93.75k
"9500": 95.0k "10000": 100.0k
[OFFSETn] : Offset n (-1023 to 1023)

Get/Sets Band Plan Setting for MOT 800custom/VHF/UHFsite when trunking control channel in custom search.

In set command, if only "," parameters are send the Band Plan setting will not changed. The set command is aborted if any format error is detected.

If [MOT_TYPE] is not CUSTOM, any other setting will be ignored.

This command is only acceptable in Programming Mode.

<COMMAND CSP>

Get/Set Custom Search Settings

Controller → Radio

CSP, [SRCH_INDEX] [\r]

CSP, [SRCH_INDEX], [NAME], [LIMIT_L], [LIMIT_H], [STP], [MOD], [ATT], [DLY], [RSV],
[HLD], [LOUT], [C-CH], [RSV], [RSV], [QUICK_KEY], [START_KEY], [RSV], [NUMBER_TAG],
[RSV], [RSV], [RSV] [\r]

Radio → Controller

CSP, [NAME], [LIMIT_L], [LIMIT_H], [STP], [MOD], [ATT], [DLY], [RSV], [HLD], [LOUT], [C-
CH], [RSV], [RSV], [QUICK_KEY], [START_KEY], [RSV], [NUMBER_TAG], [RSV],
[RSV], [RSV] [\r]

CSP,OK[\r]

[SRCH_INDEX]	: Index	(1-9,0 means 10)
[NAME]	: Name	(max.16char)
[LIMIT_L]	: Lower Limit Frequency	(250000-13000000)
[LIMIT_H]	: Upper Limit Frequency	(250000-13000000)
[STP]	: Search Step	
AUTO : AUTO	833	: 8.33k 2000 : 20k
500 : 5k	1000	: 10k 2500 : 25k
625 : 6.25k	1250	: 12.5k 5000 : 50k
750 : 7.5 k	1500	: 15k 10000 : 100k
[MOD]	: Modulation	(AUTO/AM/FM/NFM/WFM/FMB)
[ATT]	: Attenuation	(0:OFF / 1:ON)
[DLY]	: Delay Time	(-10,-5,-2,0,1,2,5,10,30)
[HLD]	: System Hold Time	(0-255)
[LOUT]	: Lockout	(0:Unlocked / 1:Lockout)
[C-CH]	: Control Channel Only	(0:OFF / 1:ON)
[QUICK_KEY]	: Quick Key	(0 - 99 / .(dot))
[START_KEY]	: Startup Configuration Key	(0 - 9/ .(dot))
[NUMBER_TAG]	: Number tag	(0-999 / NOE)

Get/Set Custom Search Settings.

In set command, only ", " parameters are not changed.

The set command is aborted if any format error is detected.

This command is only acceptable in Programming Mode.

```

<COMMAND WXS>
Get/Set Weather Settings
Controller → Radio
WXS[\r]
WXS,[DLY],[ATT],[ALT_PRI],[RSV],[RSV],[RSV] [\r]
    Radio → Controller
WXS,[DLY],[ATT],[ALT_PRI],[RSV],[RSV],[RSV] [\r]
WXS,OK[\r]

[DLY]          : Delay Time                (-10,-5,-2,0,1,2,5,10,30)
[ATT]          : Attenuation                (0:OFF / 1:ON)
[ALT_PRI]     : Weather Alert Priority      (0:OFF / 1:ON)

```

Get/Set Weather Priority Settings.
This command is only acceptable in Programming Mode.

```

<COMMAND SGP>
Get/Set SAME Group Settings
Controller → Radio
SGP,[SAME_INDEX] [\r]
SGP,[SAME_INDEX],[NAME],[FIPS1],[FIPS2],[FIPS3],[FIPS4],[FIPS5],[FIPS6],
[FIPS7],[FIPS8] [\r]
    Radio → Controller
SGP,[NAME],[FIPS1],[FIPS2],[FIPS3],[FIPS4],[FIPS5],[FIPS6],[FIPS7],[FIPS8] [\r]
SGP,OK[\r]

[SAME_INDEX]: SAME Index      (1 - 5 )
[NAME]      : SAME Group Name (max.16char)
[FIPS1-8]   : FIPS Code (6digit:000000-999999, or ----- means none)

```

Get/Set SAME Group Settings.
In set command, only ", " parameters are not changed.
The set command is aborted if any format error is detected.
This command is only acceptable in Programming Mode.

```

<COMMAND TON>
Get/Set Tone-Out Settings
Controller → Radio
TON,[INDEX][\r]
TON,[INDEX],[NAME],[FRQ],[MOD],[ATT],[DLY],[ALT],[ALTL],[TONE_A],[RSV],
[TONE_B],[RSV],[RSV],[RSV],[RSV],[ALT_PATTERN],[RSV],[RSV],
[RSV][\r]
Radio → Controller
TON,[INDEX],[NAME],[FRQ],[MOD],[ATT],[DLY],[ALT],[ALTL],[TONE_A],[RSV],
[TONE_B],[RSV],[RSV],[RSV],[RSV],[ALT_PATTERN],[RSV],[RSV],
[RSV][\r]
TON,OK[\r]

```

```

[INDEX]      : Index                (1-9,0 means 10)
[NAME]       : Name                  (max.16char)
[FRQ]        : Channel Frequency
[MOD]        : Modulation            (AUTO / FM / NFM)
[ATT]        : Attenuation           (0:OFF / 1:ON)
[DLY]        : Delay Time            (0,1,2,5,10,30 / INF : Infinite)
[ALT]        : Alert Tone            (0:OFF/1-9:Tone No.)
[ALTL]       : Alert Tone Level      (0:AUTO/1-15)
[TONE_A]     : Tone A Frequency
                ex.) 10000 means 1000.0Hz
                00000 means 0.0Hz
[RSV]        : Reserve Parameter     * This is always only "",".
[TONE_B]     : Tone B Frequency
[ALT_PATTERN]: Alert Light Pattern(0:ON / 1:Slow / 2:Fast)

```

Get/Set Tone-Out Settings.
This command is only acceptable in Programming Mode.

```

<COMMAND CNT>
Get/Set LCD Contrast Settings
Controller → Radio
CNT[\r]
CNT,[CONTRAST][\r]
Radio → Controller
CNT,[CONTRAST][\r]
CNT,OK[\r]

```

```

[CONTRAST]      : LCD Contrast          (1 - 15)

```

Get/Set LCD Contrast Settings.
This command is only acceptable in Programming Mode.

<COMMAND SCN>

Get/Set Scanner Option Settings

Controller → Radio

SCN[\r]

SCN, [DISP_MODE], [RSV], [CH_LOG], [G_ATT], [RSV], [RSV] [RSV], [RSV], [RSV],
[RSV], [RSV], [RSV], [RSV], [RSV], [RSV], [RSV], [RSV], [RSV], [RSV], [RSV] [\r]

Radio → Controller

SCN, [DISP_MODE], [RSV], [CH_LOG], [G_ATT], [RSV], [RSV], [RSV], [RSV], [RSV], [RSV],
[RSV], [RSV], [RSV], [RSV], [RSV], [RSV], [RSV], [RSV], [RSV], [RSV], [RSV] [\r]

SCN,OK[\r]

[DISP_MODE] : DISPLAY MODE (1:MODE1 / 2:MODE2 / 3:MODE3)
[CH_LOG] : Control Channel Logging (0:OFF / 1:ON / 2:Extend)
[G_ATT] : Global attenuator (0: OFF / 1: ON)
[RSV] : Reserve Parameter * This is always only ",".

Get/Set Scanner Option Settings

This command is only acceptable in Programming Mode.

<COMMAND VOL>

Get/Set Volume Level Settings

Controller → Radio

VOL[\r]

VOL, [LEVEL] [\r]

Radio → Controller

VOL, [LEVEL] [\r]

VOL,OK[\r]

[LEVEL] : Volume Level (0 - 15)

<COMMAND SQL>

Get/Set Squelch Level Settings

Controller → Radio

SQL[\r]

SQL, [LEVEL] [\r]

Radio → Controller

SQL, [LEVEL] [\r]

SQL,OK[\r]

[LEVEL] : Squelch Level (0:OPEN / 1-14 / 15:CLOSE)

```

<COMMAND DBC>
Get/Set Default Band Coverage Settings
Controller → Radio
DBC, [BNAD_NO] [\r]
DBC, [BNAD_NO], [STEP], [MOD] [\r]

```

```

Radio → Controller
DBC, [STEP], [MOD] [\r]
DBC, OK [\r]

```

```

[BAND_NO]          : Band No (1-31)
                    Band number of band coverage
[STP]              : Search Step
    500   : 5k       625   : 6.25k   750   : 7.5 k
    833   : 8.33k   1000  : 10k     1250  : 12.5k
    1500  : 15k     2000  : 20k     2500  : 25k
    5000  : 50k     10000 : 100k
[MOD]             : Modulation      (AM / NFM / FM / WFM / FMB)

```

This command is only acceptable in Programming Mode.

```

<COMMAND GDO>
Get/Set GPS Disp Option
Controller → Radio
GDO [\r]
GDO, [DISP_MODE], [UNIT], [TIME_FORMAT], [TIME_ZONE], [POS_FORMAT] [\r]
Radio → Controller
GDO, [DISP_MODE], [UNIT], [TIME_FORMAT], [TIME_ZONE], [POS_FORMAT] [\r]
GDO, OK [\r]

```

```

[DISP_MODE] : Display GPS Mode
              ( 0:ETA / 1:Clock / 2:Elevation / 3:Speed / 4:Location )
[UNIT]       : Distance Unit      ( 0: mile / 1: km )
[TIME_FORMAT]: Time Format         ( 0: 12 H / 1: 24H)
[TIME_ZONE]  : Time Zone (-14.0/-13.5/.../-0.5/0.0/0.5/.../13.5/14.0)
              ex) "-14.0" means "- 14.0 H".
[POS_FORMAT] : Position Format     ( DMS / DEG )

```

This command is only acceptable in Programming Mode.

```

<COMMAND BSP>
Get/Set Band Scope System Settings
Controller → Radio
BSP[\r]
BSP, [FRQ], [STP], [SPN], [MAX_HOLD] [\r]
Radio → Controller
BSP, [FRQ], [STP], [SPN], [MAX_HOLD] [\r]
BSP,OK[\r]
    [FRQ]                : Center Frequency
    [STP]                : Search Step
        500      : 5k          625      : 6.25k      750      : 7.5 k
        833      : 8.33k      1000     : 10k         1250     : 12.5k
        1500     : 15k         2000     : 20k         2500     : 25k
        5000     : 50k         10000    : 100k
    [SPN]                : Sweep Span
        0.2M,     0.4M,     0.6M,
        0.8M,     1M,       2M,
        4M,       6M,       8M,
        10M,     20M,     40M,
        60M,     80M,     100M,
        120M,    140M,    160M,
        180M,    200M,    250M,
        300M,    350M,    400M,
        450M,    500M
    [MAX_HOLD]          : Max Hold Display          (0:OFF / 1:ON)

```

Get/Set Band Scope System Settings.
 In set command, only "," parameters are not changed.
 The set command is aborted if any format error is detected.

This command is only acceptable in Programming Mode.

```

<COMMAND GIE>
Get Global IF exchange Frequency
Controller → Radio
GIE [\r]
Radio → Controller
GIE, [FRQ] [\r]
GIE, -1 [\r]

    [FRQ]                : IF Exchange Frequency          (250000-13000000)

```

This command is used to get Global IF exchange frequency list.
 You should call this command again and again to get all global IF exchange frequencies until the scanner returns "-1".
 "-1" means that no more IF exchange frequency exists.
 This command is only acceptable in Programming Mode.

```
<COMMAND CIE>
Clear IF exchange Frequency
Controller → Radio
CIE,[FRQ][\r]
Radio → Controller
CIE,OK[\r]
```

[FRQ] : IF Exchange Frequency (250000-13000000)

This command clear Frequency from Global IF exchange Frequency list.
This command is only acceptable in Programming Mode.

```
<COMMAND RIE>
Register IF exchange Frequency
Controller → Radio
RIE,[FRQ][\r]
Radio → Controller
RIE,OK[\r]
```

[FRQ] : IF Exchange Frequency (250000-13000000)

This command register Frequency to Global IF exchange Frequency list.
This command is only acceptable in Programming Mode.

```
<COMMAND BAV>
*Get Battery Voltage

Controller → Radio
BAV[\r]
Radio → Controller
BAV,####[\r] : A/D Value (0-1023)
```

Battery Level[V] = (3.2[V] * #### * 2)/1023

Returns current battery voltage.
This command is for test mode.

```
<COMMAND WIN>
*Get Window Voltage
Controller → Radio
WIN[\r]
Radio → Controller
WIN,###,[FRQ][\r] : ### : A/D Value (0-255)
```

Returns current window voltage and its frequency.
The order of the frequency digits is from 1 GHz digit to 100 Hz digit.
This command is for test mode.

CTCSS/DCS CODE LIST

CTCSS

MODE	CODE
CTCSS 67.0Hz	64
CTCSS 69.3Hz	65
CTCSS 71.9Hz	66
CTCSS 74.4Hz	67
CTCSS 77.0Hz	68
CTCSS 79.7Hz	69
CTCSS 82.5Hz	70
CTCSS 85.4Hz	71
CTCSS 88.5Hz	72
CTCSS 91.5Hz	73
CTCSS 94.8Hz	74
CTCSS 97.4Hz	75
CTCSS 100.0Hz	76
CTCSS 103.5Hz	77
CTCSS 107.2Hz	78
CTCSS 110.9Hz	79

CTCSS 114.8Hz	80
CTCSS 118.8Hz	81
CTCSS 123.0Hz	82
CTCSS 127.3Hz	83
CTCSS 131.8Hz	84
CTCSS 136.5Hz	85
CTCSS 141.3Hz	86
CTCSS 146.2Hz	87
CTCSS 151.4Hz	88
CTCSS 156.7Hz	89
CTCSS 159.8Hz	90
CTCSS 162.2Hz	91
CTCSS 165.5Hz	92
CTCSS 167.9Hz	93
CTCSS 171.3Hz	94
CTCSS 173.8Hz	95
CTCSS 177.3Hz	96

CTCSS 179.9Hz	97
CTCSS 183.5Hz	98
CTCSS 186.2Hz	99
CTCSS 189.9Hz	100
CTCSS 192.8Hz	101
CTCSS 196.6Hz	102
CTCSS 199.5Hz	103
CTCSS 203.5Hz	104
CTCSS 206.5Hz	105
CTCSS 210.7Hz	106
CTCSS 218.1Hz	107
CTCSS 225.7Hz	108
CTCSS 229.1Hz	109
CTCSS 233.6Hz	110
CTCSS 241.8Hz	111
CTCSS 250.3Hz	112
CTCSS 254.1Hz	113

DCS

MODE	CODE
DCS 023	128
DCS 025	129
DCS 026	130
DCS 031	131
DCS 032	132
DCS 036	133
DCS 043	134
DCS 047	135
DCS 051	136
DCS 053	137
DCS 054	138
DCS 065	139
DCS 071	140
DCS 072	141
DCS 073	142
DCS 074	143
DCS 114	144
DCS 115	145
DCS 116	146
DCS 122	147
DCS 125	148
DCS 131	149
DCS 132	150
DCS 134	151
DCS 143	152
DCS 145	153
DCS 152	154
DCS 155	155
DCS 156	156
DCS 162	157
DCS 165	158
DCS 172	159
DCS 174	160
DCS 205	161
DCS 212	162
DCS 223	163
DCS 225	164
DCS 226	165

DCS 243	166
DCS 244	167
DCS 245	168
DCS 246	169
DCS 251	170
DCS 252	171
DCS 255	172
DCS 261	173
DCS 263	174
DCS 265	175
DCS 266	176
DCS 271	177
DCS 274	178
DCS 306	179
DCS 311	180
DCS 315	181
DCS 325	182
DCS 331	183
DCS 332	184
DCS 343	185
DCS 346	186
DCS 351	187
DCS 356	188
DCS 364	189
DCS 365	190
DCS 371	191
DCS 411	192
DCS 412	193
DCS 413	194
DCS 423	195
DCS 431	196
DCS 432	197
DCS 445	198
DCS 446	199
DCS 452	200
DCS 454	201
DCS 455	202
DCS 462	203
DCS 464	204

DCS 465	205
DCS 466	206
DCS 503	207
DCS 506	208
DCS 516	209
DCS 523	210
DCS 526	211
DCS 532	212
DCS 546	213
DCS 565	214
DCS 606	215
DCS 612	216
DCS 624	217
DCS 627	218
DCS 631	219
DCS 632	220
DCS 654	221
DCS 662	222
DCS 664	223
DCS 703	224
DCS 712	225
DCS 723	226
DCS 731	227
DCS 732	228
DCS 734	229
DCS 743	230
DCS 754	231

FONT DATA

Character pattern of 8 x 16 dot

This character pattern is Large Font.

*In this document, characters of these areas are described as normal characters.

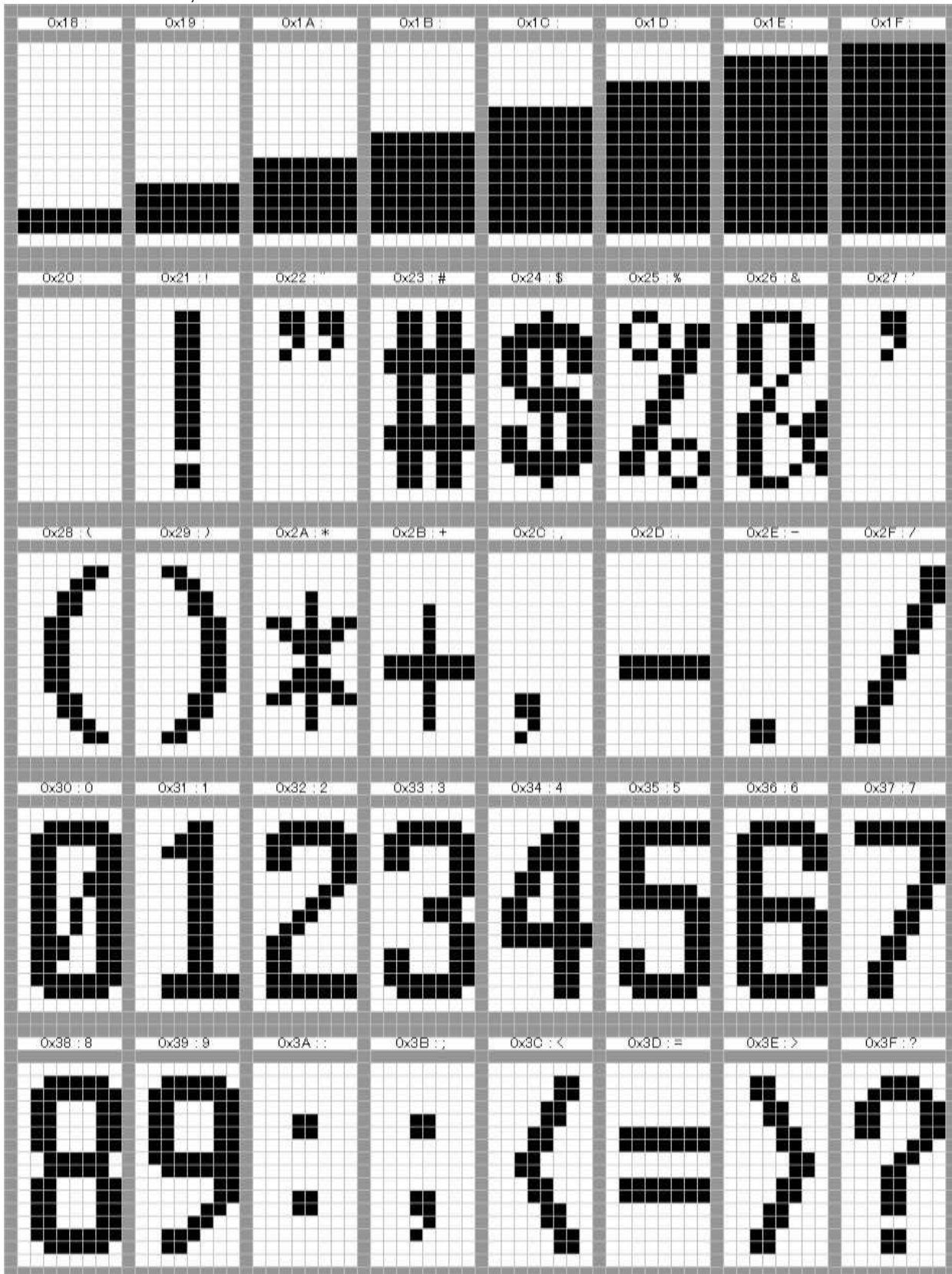



0x68 : h	0x69 : i	0x6A : j	0x6B : k	0x6C : l	0x6D : m	0x6E : n	0x6F : o
0x70 : p	0x71 : q	0x72 : r	0x73 : s	0x74 : t	0x75 : u	0x76 : v	0x77 : w
0x78 : x	0x79 : y	0x7A : z	0x7B : {	0x7C :	0x7D : }	0x7E : ~	0x7F :
0x80 : █	0x81 : ↑	0x82 : ↓	0x83 :	0x84 : ↙	0x85 : ↘	0x86 : ↙	0x87 : ↘
0x88 :	0x89 : ↙	0x8A : ↘	0x8B :	0x8C :	0x8D : ↙	0x8E : ↘	0x8F : ↙

0x90 : ARROW_L	0x91 : ARROW_L	0x92 : ARROW_L	0x93 : ARROW_L	0x94 : ARROW_R	0x95 : ARROW_R	0x96 : ARROW_R	0x97 : ARROW_R
0x98 : ARROW_U	0x99 : ARROW_U	0x9A : ARROW_U	0x9B : ARROW_U	0x9C : ARROW_D	0x9D : ARROW_D	0x9E : ARROW_D	0x9F : ARROW_D
0xA0 :	0xA1 : ARROW_L	0xA2 : ARROW_L	0xA3 :	0xA4 : EAST	0xA5 : EAST	0xA6 : NORTH	0xA7 : NORTH
0xA8 : WEST	0xA9 : WEST	0xAA : SOUTH	0xAB : SOUTH	0xAC : ARROW_L	0xAD : ARROW_L	0xAE : ARROW_L	0xAF : ARROW_L
0xB0 :	0xB1 :	0xB2 :	0xB3 :	0xB4 : ARROW_U	0xB5 : ARROW_U	0xB6 : ARROW_U	0xB7 : ARROW_U

0xB8 : ARROW_	0xB9 : ARROW_	0xBA : ARROW_	0xBB :	0xBC : ARROW	0xBD : ARROW	0xBE : ARROW	0xBF : ARROW
0xC0 : ARROW_	0xC1 : ARROW_	0xC2 : ARROW_	0xC3 : ARROW_	0xC4 : ARROW	0xC5 : ARROW	0xC6 : ARROW	0xC7 : ARROW
0xC8 : ARROW_	0xC9 : ARROW_	0xCA : ARROW_	0xCB : ARROW_	0xCC :	0xCD :	0xCE :	0xCF :
0xD0 : ARROW_	0xD1 : ARROW_	0xD2 : ARROW_	0xD3 : ARROW_	0xD4 : FUNC	0xD5 : BAR R1	0xD6 : BAR R2	0xD7 : BAR R3
0xD8 : ARROW_	0xD9 : ARROW_	0xDA : ARROW_	0xDE : ARROW_	0xDC : BAR R4	0xDD : L/O	0xDE : L/O	0xDF : L/O

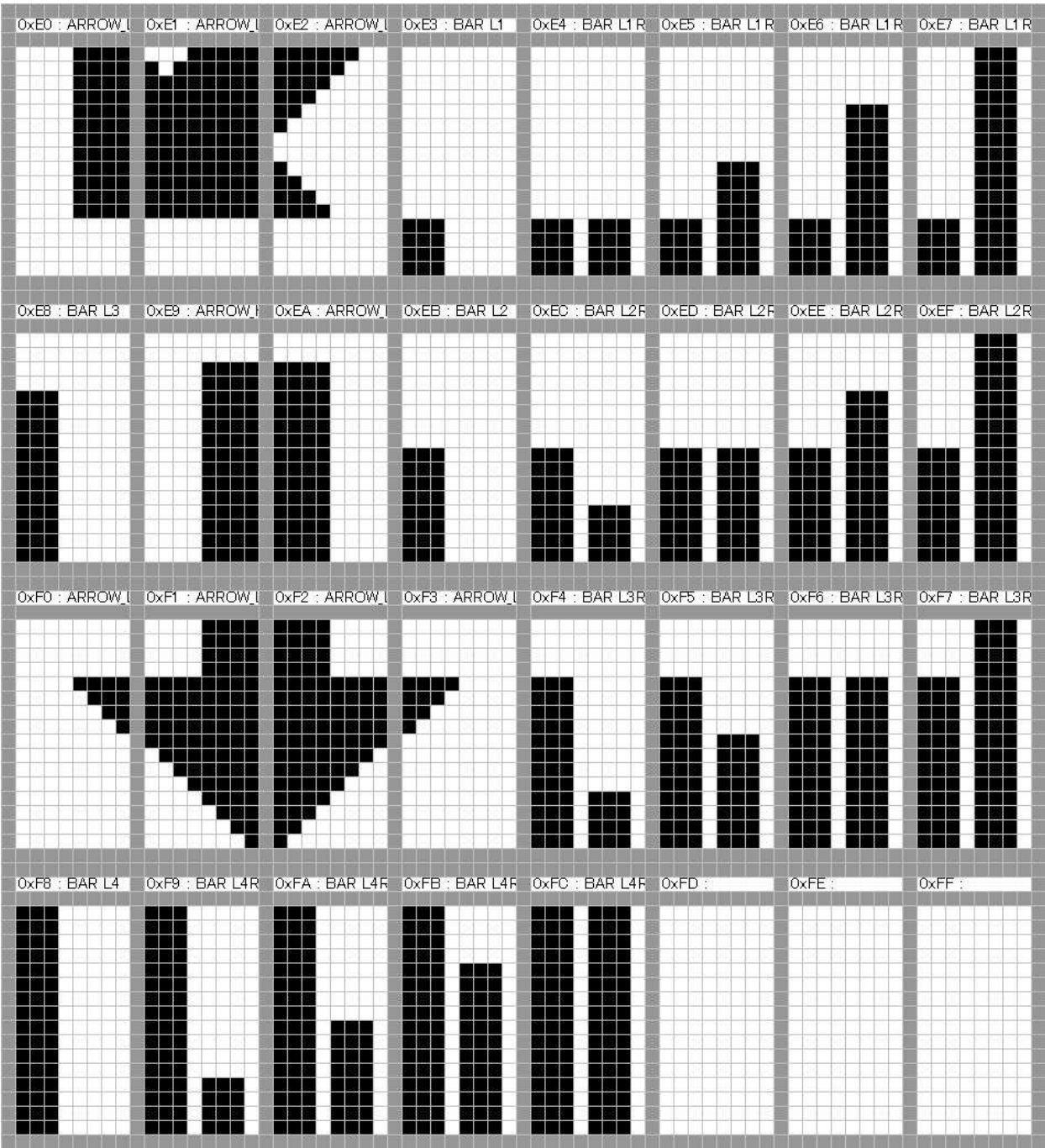

Character pattern of 8 x 8 dot

This character pattern is Small Font.





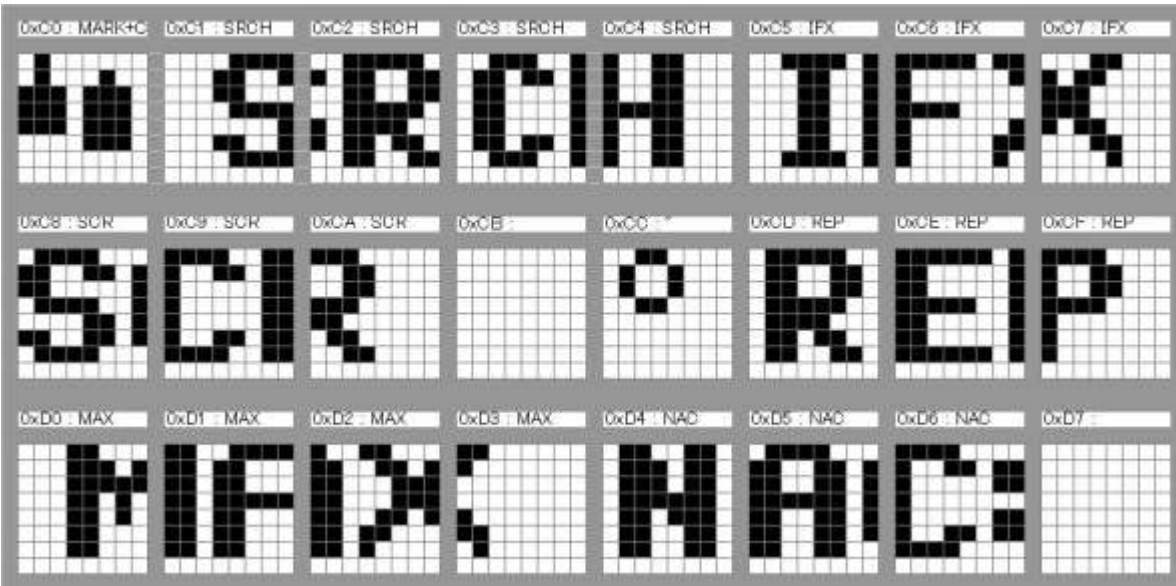

Menu reference

BC346XT main menu

- [Program System](#)
- [Program Location](#)
- [Srch/CloCall Opt](#)
- [Search for...](#)
- [Close Call](#)
- [Priority Scan](#)
- [WX Operation](#)
- [Tone-Out for...](#)
- [Wired Clone](#)
- [Settings](#)

Using the menu

- To open the menu, tap **MENU** .
- Turn the **SELECT-VOLUME-SQUELCH** knob to move the cursor and highlight menu items. The currently highlighted item appears in reversed-out text.
- To select the highlighted item or confirm an option setting, tap **E-YES** or press down on the **SELECT-VOLUME-SQUELCH** knob.
- To cancel an option setting, press **NO** .
- To go back one level in the menu, tap **MENU** .
- To exit the menu, press **LOCKOUT** . The scanner goes back to the operating mode it was in before you entered the menu.

This page applies to the following scanner(s): [BC346XT Users Guide](#)

BC346XT displays

To determine whether the information on this page applies to your scanner, see the tags at the bottom of the page.

The display icons vary depending on the status of the scanner and what you're doing at any given time. The diagram shows common icon locations, and table below lists the most common icons and their meanings:

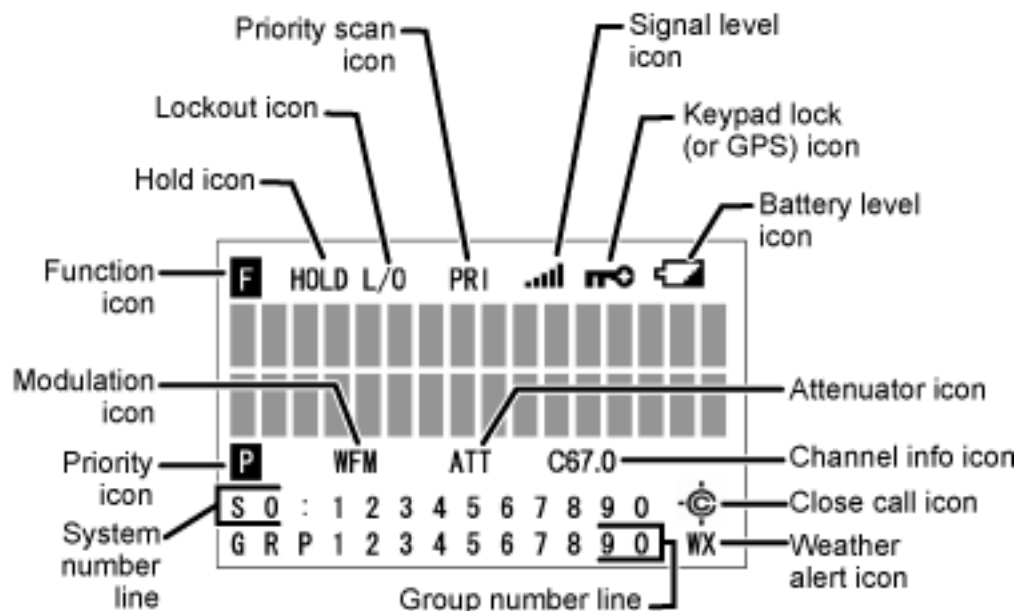

Attenuator icon	Steady: The attenuator is turned on for the current channel.
	Blinking: The attenuator is turned on globally (for all channels).
Battery level icon	x.xx: The remaining battery voltage is displayed in place of the Xs.
	Blinking icon: The battery is low. (If the AC adapter is connected while the icon is blinking, the battery is incorrectly installed, is the wrong type, or has gone bad.)

Channel Info icon	Cxx.x: The scanner has detected a CTCSS code; the received code is displayed in place of the Xs.
	DCSxxx: The scanner has detected a DCS code; the received code is displayed in place of the Xs.
Close call icon	Normal (open) icon: <ul style="list-style-type: none"> • Steady: Close call priority mode is on. • Blinking: Close Call Only mode is on, or the scanner has detected a close call signal.
	Reversed (filled) icon: <ul style="list-style-type: none"> • Steady: Close call DND mode is on. • Blinking: Close call DND mode is on, and the scanner has detected a close call signal.
Function icon	Steady: You tapped the FUNCTION key; the scanner will remember the FUNCTION + key combination for the next 3 seconds.
	Blinking: You pressed & held the FUNCTION key; the scanner will remember the FUNCTION + key combination until you tap FUNCTION again.
Group number line (GRP)	In Scan mode: The group Quick Key numbers (GQK) of any unlocked groups in the current system or site are displayed on this line. The GQK number of the group that is currently being scanned blinks.
	In Hold mode: This line displays the GQK number of the current group only.
	In Custom Search mode: The numbers of any programmed search ranges are display on this line. The number of the custom range that is currently being searched blinks.
Hold icon	The scanner is in Hold mode.

IFX icon	You switched to the intermediate frequency (IF exchange).
Keypad lock (or GPS) icon	(key symbol): The keypad is locked.
	GPS: The scanner is receiving data from the GPS device.
Lockout icon	The current channel is locked out.
Modulation icon	This icon displays the modulation type of the current channel: AM, FM, NFM, FMB, or WFM.
Priority icon	The current channel is set as a priority channel.
Priority scan icon (PRI)	Steady: Priority scan is turned on.
	Blinking: Priority Plus scan is turned on.
REP icon	The Repeater Find feature is turned on.
Signal level icon	This icon displays the strength of the current signal; the icon ranges from zero bars (no signal) to five bars (strong signal).
System number line (Sx:)	In Scan mode: The system/site Quick Key numbers (SQK) of any unlocked systems or sites are displayed on this line. The SQK number of the system or site that is currently being scanned blinks. For SQK numbers above 9, the tens digit replaces the X in the icon; the ones digits are shown on this line.
	In Hold mode: This line displays the SQK number of the current system or site only. For SQK numbers above 9, the tens digit replaces the X in the icon; the ones digit is displayed on this line.
	In Service Search mode: The icon SCR replaces the System numbers if the broadcast screen feature is turned on.
Weather alert icon	Weather Alert Priority scan is turned on.

Special displays

In some operation modes, the display can be very different from the main display. These modes also have 2 or 3 different displays you can cycle through.

- [Band Scope mode display](#)
- [Hold mode displays](#)
- [GPS mode display](#)

This page applies to the following scanner(s): [BC346XT Users Guide](#)

Skywarn ▶

Frequency	Input	License	Type	Tone	Alpha Tag	Description	Mode	Tag
146.94000	146.34000	<u>K5FTW-R</u>	RM	110.9 PL	TC RACES Pri	Tarrant County RACES/Skywarn Primary	FM	Ham
146.76000	146.16000	<u>K5FTW-R</u>	RM	110.9 PL	TC RACES B/U	Tarrant County RACES/Skywarn Backup	FM	Ham
444.10000	449.10000	<u>K5FTW-R</u>	RM	110.9 PL	TC RACES Adm	Tarrant County Backup / Admin / Secondary Net Freq.	FM	Ham
224.94000	223.34000	<u>K5FTW-R</u>	RM	110.9 PL	TC RACES Int	Tarrant County Admin Freq. / WX Service Intercom Freq.	FM	Ham

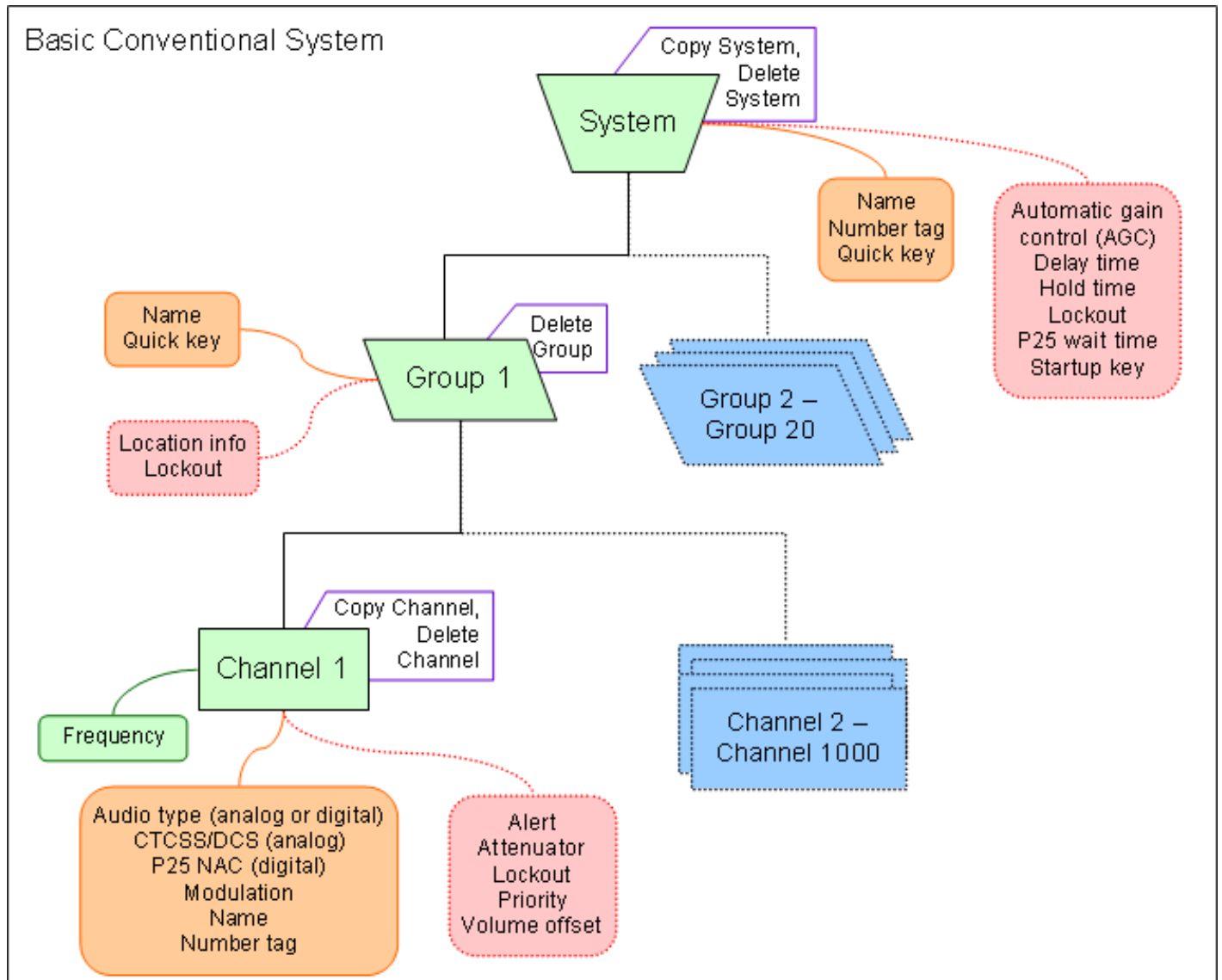

System Layout Legend

Items

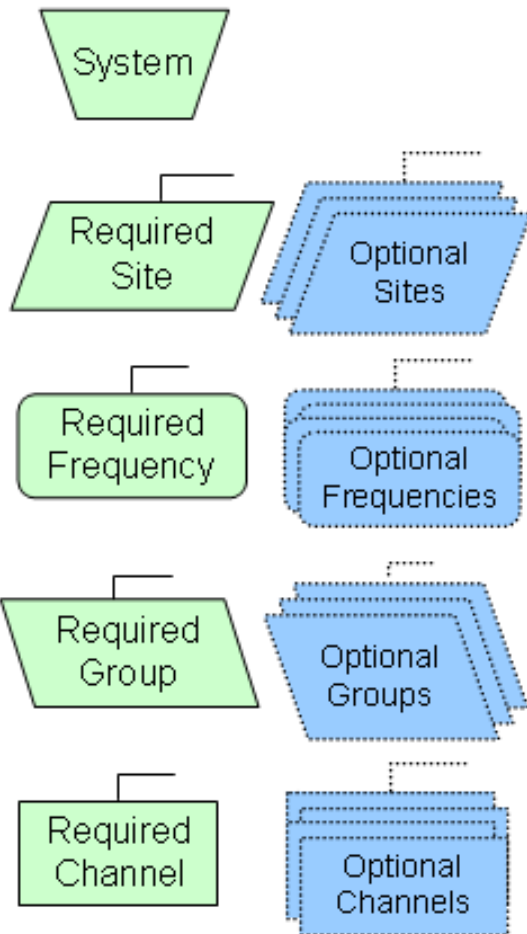

Properties

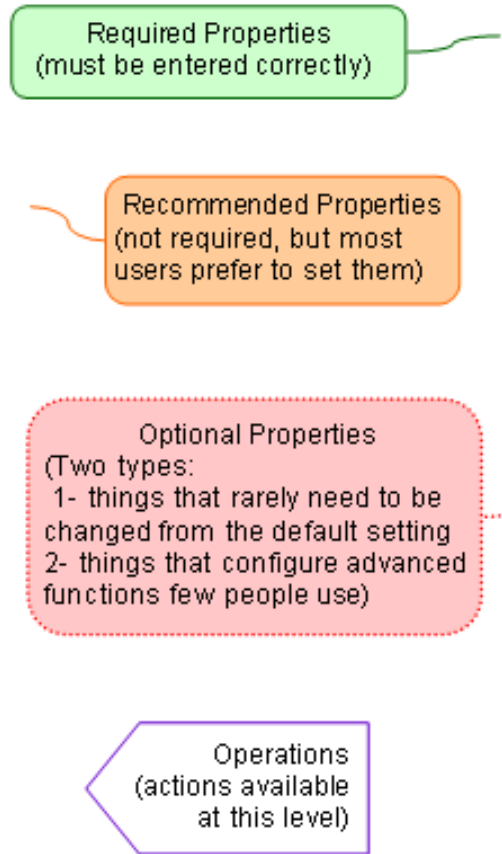

Program System

To determine whether the information on this page applies to your scanner, see the tags at the bottom of the page.

The *Program System* menu lets you create systems and edit existing systems. All existing systems are listed in the order they were created: select the system you want to edit, or select *New System* to create a new one.

When you create a new system, the scanner prompts you to select a system type; the system type you select controls what options are available for the system setup. You can't change a system type once the system is created: if you need to change the system type, delete the system and create it all over again as a new system.

The *System Type* options are:

- *P25* : Use for any P25 system. When you select this system type, the scanner prompts you to choose *Standard Trunk* or *One-Freq* .
- *MOT* : Use for any Motorola system.
- *EDCS* : Use for any EDACs system. When you select this system type, the scanner prompts you to choose *WIDE/NARROW* or *SCAT* .
- *LT* : Use for any LTR system.
- *Conventional* : Use for any non-trunked system.

REMEMBER: once you select a system type, you cant change it!

- [Edit Name](#)
- [Edit Sys Option](#)
- [Edit Site](#)
- [Edit Group](#)
- [Copy System](#)
- [Delete System](#)
- [New System](#)

Edit Name

Enter a name or edit the existing one. Names can be 16 characters long, and they can contain upper and lower case letters, punctuation, and spaces. Turn the **SELECT-VOLUME-SQUELCH** knob on the handheld scanners or the **SCROLL / FUNCTION** knob on mobile scanners to choose the character you want, then press **6** (right cursor) to move the cursor to the next character.

Edit Sys Option

This menu lets you set the options for each system.

Edit Site

(trunked systems only) This menu lets you create sites and edit existing sites. All existing sites are listed in Site Quick Key order: select the site you want to edit, or select New Site to create a new one.

Edit Group

This menu lets you create groups and edit existing groups. All existing groups are listed in Group Quick Key order: select the group you want to edit, or select New Group to create a new one. You can have up to 20 groups in each system.

Copy System

Make a copy of this system and all its settings including all sites, groups, channels, and frequencies. The scanner prompts you to enter a new system name.

Delete System

Delete this system and all its settings; this includes sites, groups, channels, and frequencies.

New System

Create a new system.

This page applies to the following scanner(s): [BCD996XT](#) [BCD396XT](#) [Users Guide](#)

Edit Sys Option

To determine whether the information on this page applies to your scanner, see the tags at the bottom of the page.

System options vary depending on the system type.

- [Global system options](#)
 - [Set Number Tag](#)
 - [Set Delay Time](#)
 - [Set Audio AGC](#)
 - [Set Record \(BCD996XT and BCT15X Only\)](#)
- [Conventional system options](#)
 - [Set Quick Key](#)
 - [Set Startup Key](#)
 - [Set Lockout](#)
 - [Set Hold Time](#)
 - [P25 Waiting Time \(BCD396XT and BCD996XT Only\)](#)
- [Trunked system options](#)
 - [ID Scan/Search](#)
 - [Priority ID Scan](#)
 - [Emergency Alert](#)
 - [Set ID Format \(DEC/HEX\) or \(AFS/DEC\)](#)
 - [Rvw ID:Srch L/O](#)
 - [Clr All L/O IDs](#)
- [Motorola system options](#)
 - [Edit Fleet Map](#)
 - [Set Status Bit](#)
 - [Set End Code](#)
- [P25 System options \(BCD396XT and BCD996XT Only\)](#)
 - [P25 NAC Option](#)

Global system options

The following options are available for all types of systems.

Set Number Tag

Assign a number to this system or channel that you can use to tune directly to a specific channel. Choose a number from 0 to 999. (For more information, see [Number Tags](#).)

Set Delay Time

Set the number of seconds the scanner should wait after a transmission stops before moving on to the next channel. Select 0, 1, 2 (default), 5, 10, or 30 *seconds*.

To have scanner leave the channel after a designated number of seconds whether the transmission stops or not, select one of the negative values. Choose -10 seconds to have the scanner leave the channel after 10 seconds even if the transmission is still going on; choose -5 *seconds* or -2 *seconds* to have the scanner leave after 5 seconds or 2 seconds, respectively.

Set Audio AGC

Turn on Automatic Gain Control (AGC) for this system. When you activate this feature, the scanner automatically adjusts the volume for each channel based on the signal strength. You can turn on the gain control for *Analog* and *Digital* signals separately.

To change the settings for the audio AGC, see [Adjust Audio AGC](#)

Set Record ([BCD996XT](#) and [BCT15X](#) Only)

Set whether the audio from channels on the system come out the RECORD OUT jack on the back of the scanner. You have three options:

- All Channel -- All channels in the system go to the RECORD OUT jack.
- Marked Channel -- Only those channels that have the RECORD option turned on go to the RECORD OUT jack.
- Off -- No channels in the system go to the RECORD OUT jack (even those with the RECORD option turned on).

Conventional system options

The following options are available when you're editing a conventional system:

Set Quick Key

Assign this system or site to a Quick Key so you can easily enable or disable it during scanning. Enter a number from 0 to 99; tap NO (the decimal point) if you don't want to assign this system or site to a Quick Key. (For more information, see [Quick Keys](#).)

Set Startup Key

Assign this system or site to a Startup Key so you can lock or unlock it during power up. Enter a number from 0 to 9; tap NO (the decimal point) if you don't want to assign this system or site to a Startup Key. (For more information, see [Startup Keys](#).)

Set Lockout

Decide whether you want to lock out the system so the scanner will ignore it during Scan and Search modes. If you lock out a system, all channels within that system are locked out. Choose one of the following options:

- Unlocked: The system is not locked out.
- Temporary L/O: The system is locked out until you turn the scanner off and back on.
- Lockout: The system is permanently locked out.

Set Hold Time

Set the minimum number of seconds the scanner should spend checking this system or site even if there is no traffic on any channel. (The scanner always checks each channel in a system or site once even if the hold time is set to 0 seconds.) Select the number of seconds from 0 through 255 (2 is the default).

P25 Waiting Time ([BCD396XT](#) and [BCD996XT](#) Only)

On channels that contain a mix of analog and digital signals (i.e., where the *Audio Mode* is set to *All*), it is possible to have *false decode* problems caused by digital noise at the

beginning of transmissions. To prevent this, a user-configurable P25 wait time (from 0 to 1000 ms) has been added.

During the wait time, the scanner evaluates the received signal; if it detects P25 data, the scanner opens squelch immediately. If it does not detect any P25 data, the scanner opens squelch as soon as the wait time expires.

Note: Any analog transmissions on this channel will lose the first part of the transmission, up to the wait time you set here.

Select the number of milliseconds (after the start of a transmission) the scanner should wait while checking for P25 data. Choose a number from 0 through 1000 ms in 100 ms increments. The scanner only applies the wait time setting to Conventional or Motorola (non P25) systems, and only when the channel's *Audio Mode* setting is *All*.

Trunked system options

The following options are available when you're editing a trunked system:

ID Scan/Search

Choose whether the scanner only checks the Talk Group IDs that you program (*ID Scan*) or checks all the Talk Group IDs it can find (*ID Search*) when scanning this site.

Priority ID Scan

Choose *On* to have the scanner check any priority-labeled channels in this system during Priority ID Scan mode. Choose *Off* if you want the scanner to ignore this system when scanning priority channels.

Emergency Alert

This menu lets you configure whether the scanner triggers an alert tone and light when it detects an emergency flag within an active Talk Group. (Compare this to the channel setting [Set Alert](#), which can trigger an alert tone and light whenever a channel becomes active.) The settings for [Set Alert Tone](#) and [Set Alert Light](#) are common to both types of alerts.

Set ID Format (DEC/HEX) or (AFS/DEC)

Trunked systems have three different formats for the Talk Group ID, but not all formats are used by each system type. Choose the Talk Group ID format used by this system:

- *Dec* : The system uses a decimal (base 10) format for the Talk Group IDs (available for all trunked systems)
- *Hex* : The system uses a hexadecimal (base 16) format for the Talk Group IDs (available for P25 and Motorola systems only)
- *AFS* : The system uses the Agency-Fleet-Subfleet format for the Talk Group IDs (available for EDACS wide or narrow systems only)

Rvw ID:Srch L/O

This feature displays a list of all locked out Talk Group IDs. If you want to unlock a Talk Group ID, just select it from the list and press **YES** .

Clr All L/O IDs

Choose yes to unlock all the Talk Group IDs in this system or site. (Choose no to cancel and go back to the previous screen.)

Motorola system options

The following options are available when only when you're editing a Motorola system:

Edit Fleet Map

(Motorola Type I or Hybrid systems only) This menu lets you choose one of the 16 pre-programmed fleet maps; select *Custom* to manually program your own fleet map information. (See [Motorola fleet maps](#) for more information.)

Set Status Bit

Choose *Yes* to have the scanner check the status bit in each TalkGroup ID, or choose *Ignore* to ignore all status bits in this system.

Set End Code

Choose whether the scanner recognizes any end transmission codes when deciding to leave a channel. You have the following options:

[BCD396XT](#) and [BCD996XT](#):

- *Analog*: The scanner recognizes only analog end transmission codes.
- *Analog-Digital*: The scanner recognizes both analog and digital end codes.
- *Ignore*: The scanner waits for the carrier to drop before leaving a channel.

[BC346XT](#) and [BCT15X](#)

- *Yes*: The scanner recognizes end transmission codes.
- *Ignore*: The scanner waits for the carrier to drop before leaving a channel.

P25 System options ([BCD396XT](#) and [BCD996XT](#) Only)

The following options are available when only when you're editing a P25 system:

P25 NAC Option

(P25 single frequency systems only) Choose whether the scanner limits reception to transmissions that include a specific Network Access Code (NAC) for this system or frequency.

- *Search*: The scanner opens squelch for any digital signal, but displays the NAC being used.
- *Set P25 NAC*: The scanner opens squelch only for signals that include the NAC you enter here. Enter a hexadecimal number between *0* and *FFF*.

This page applies to the following scanner(s): [BCD996XT](#) [BCT15X](#) [BCD396XT](#)
[BC346XT Users Guide](#)

Edit Group

To determine whether the information on this page applies to your scanner, see the tags at the bottom of the page.

When you create a new channel group, the scanner automatically assigns a default name of Group XX, where XX is a 2-digit sequential number (1 through 20).

- [Options available for all groups:](#)
 - [Edit Name](#)
 - [Set Quick Key](#)
 - [Edit Channel](#)
 - [Set LocationInfo](#)
 - [Set Lockout](#)
 - [Delete Group](#)
 - [New Group](#)

Options available for all groups:

You have the following options for channel groups:

Edit Name

Enter a name or edit the existing one. Names can be 16 characters long, and they can contain upper and lower case letters, punctuation, and spaces. Turn the **SELECT-VOLUME-SQUELCH** knob on the handheld scanners or the **SCROLL / FUNCTION** knob on mobile scanners to choose the character you want, then press **6** (right cursor) to move the cursor to the next character.

Set Quick Key

Assign this group to a Quick Key so you can easily enable or disable it during scanning. Enter a number from 0 to 9; tap NO (the decimal point) if you don't want to assign this group to a Quick Key. (For more information, see [Quick Keys](#).)

Edit Channel

Use this menu to program channel information for this group. Click on your scanner model below to go the correct Edit channel menu:

- [BCD396XT and BCD996XT Edit Channel](#) menu
- [BC346XT and BCT15X Edit Channel](#) menu

Set LocationInfo

Use this menu to program location information for this group.

Set Lockout

Decide whether you want to lock out the channel group so the scanner will ignore it during Scan and Search modes. If you lock out the channel group, all channels in the group are also ignored during Scan and Search. Choose one of the following options:

- Unlocked: The channel group is not locked out.
- Temporary L/O: The channel group is locked out until you turn the scanner off and back on.
- Lockout: The channel group is permanently locked out.

Delete Group

Delete this group and all its settings, including any channels and frequencies.

New Group

Create a new group.

This page applies to the following scanner(s): [BCD996XT](#) [BCT15X](#) [BCD396XT](#)
[BC346XT](#) [Users Guide](#)

Set LocationInfo

Use this menu to configure geographic information for each system or site. With this information and a standard NMEA GPS input, the scanner can automatically change which systems, sites and channel groups it scans as you change location. You must set the location information if you want to use Location-based Scanning.

Set Latitude and Set Longitude

Enter the latitude and longitude of the center of this system or site. You can use any geographical coordinates as the center, but most often it will be the physical location of the antenna, the center of a city, county, or other geopolitical territory, or some combination of the two.

Geographical coordinates can be represented in a few different ways. The two most common representations are DMS and Deg.

DMS breaks the coordinate into Degrees, Minutes, and Seconds. This is typically represented like: 44° 58' 12.79" N. Your scanner uses this format.

Decimal degrees simply use the degrees expressed as a decimal number. 44° 59' 12" equates to 44.97381 Degrees. Mathematically, you can change DMS to Deg using the formula $DDD + MM/60 + SS.ss/3600$. You would perform the reverse calculation to convert Deg to DMS.

To more easily convert Decimal Degrees to the DDD° MM' SS.sss" format or vice versa, see the converter at this [link](#).

Set Range

Enter the maximum distance from the center that this site or channel will be active. As long as your position is within the radius you enter here, the scanner monitors this site or channel; when you leave the channel range, the scanner locks out this site or channel. The scanner treats the number you enter here as miles or kilometers depending on the value you selected in the Set Unit field in the Set GPS Format menu (under the main Settings menu). Enter a range from 0.5 through 125.0 mi/km, in 0.5 mi/km steps.

Set GPS Enable

(A GPS unit must be connected)

Turn this feature on if you want the scanner to lock out this site or channel group when you leave the range and enable the site or channel group when you are within the range.

This page applies to the following scanner(s): [BCD996XT](#) [BCT15X](#) [BCD396XT](#)
[BC346XT Users Guide](#)

Edit Channel

To determine whether the information on this page applies to your scanner, see the tags at the bottom of the page.

This menu lets you create channels and edit existing channels. All existing channels are listed in alphabetical order: select the channel you want to edit, or select New Channel to create a new one. You can have up to 1000 channels in a conventional system and 500 channels in a trunked system.

When you create a new channel, the scanner prompts you to enter the frequency (in a conventional system) or the Talk Group ID (in a trunked system) for the channel: you can edit these at any time through this menu.

- [Edit Frequency \(conventional systems\)](#)
- [Edit Talk Group ID \(trunked systems\)](#)
- [Options available for all channels:](#)
 - [Edit Name](#)
 - [Set Audio Type](#)
 - [Set Number Tag](#)
 - [Set Modulation](#)
 - [Set Attenuator](#)
 - [Set Priority](#)
 - [Set Alert](#)
 - [Set Record \(BCD996XT and BCT15X only\)](#)
 - [Set Lockout](#)
 - [Volume Offset](#)
 - [Copy Channel](#)
 - [Delete Channel](#)
 - [New Channel](#)
- [Analog channel options](#)
 - [Set CTCSS/DCS](#)
- [Digital channel options](#)
 - [P25 NAC Option](#)

Edit Frequency (conventional systems)

Enter a valid frequency for this band. If the frequency is invalid or if it already exists, the scanner sounds an error tone and prompts you enter the frequency again.

Edit Talk Group ID (trunked systems)

Options available for all channels:

You have the following options for channels (click on any setting for an explanation):

Edit Name

Enter a name or edit the existing one. Names can be 16 characters long, and they can contain upper and lower case letters, punctuation, and spaces. Turn the **SELECT-VOLUME-SQUELCH** knob on the handheld scanners or the **SCROLL / FUNCTION** knob on mobile scanners to choose the character you want, then press **6** (right cursor) to move the cursor to the next character.

Set Audio Type

Select the type of audio signal contained on this channel. Choose *Digital Only* or *Analog Only* according to the signal type; select *All* if this channel might contain both digital and analog signals.

Set Number Tag

Assign a number to this system or channel that you can use to tune directly to a specific channel. Choose a number from 0 to 999. (For more information, see [Number Tags](#).)

Set Modulation

Select what type of modulation the scanner should use for this frequency or channel. (Only the modulation types available for this frequency or channel are displayed.)

Auto	The scanner uses the default modulation type for this frequency's band.
AM	The scanner treats the frequency as an AM band.
NFM	The scanner treats the frequency as a Narrowband FM band.
FM	The scanner treats the frequency as an FM band.
WFM	The scanner treats the frequency as a Wideband FM band.
FMB	The scanner treats the frequency as an FM broadcast band.

Set Attenuator

Turn on attenuation to reduce the signal strength by 20 dB. You can turn on attenuation for individual frequencies and channels or for entire sites. If you turn on attenuation for a site, all frequencies within that site will be attenuated.

Set Priority

Choose whether this channel should be flagged as a priority channel so the scanner checks it during priority scans and searches.

Set Alert

This menu lets you configure whether the scanner triggers an alert tone and light whenever this channel or frequency becomes active. (Compare this to the system setting [Emergency Alert](#), which triggers a tone and light when a Talk Group contains an emergency flag.) The available options for [Set Alert Tone](#) and [Set Alert Light](#) are common to both types of alerts.

Set Record ([BCD996XT](#) and [BCT15X](#) only)

This item lets you select whether the channel's audio is output from the RECORD OUT jack on the back of the scanner. Note that you must also set the RECORD --> Marked Channel System Option to fully enable this function.

Set Lockout

Decide whether you want to lock out the channel so the scanner will ignore it during Scan and Search modes. Choose one of the following options:

- Unlocked: The channel is not locked out.
- Temporary L/O: The channel is locked out until you turn the scanner off and back on.
- Lockout: The channel is permanently locked out.

Volume Offset

The scanner can automatically adjust the volume when it tunes to this channel or frequency. Enter one of the following options:

Softer	No Change	Louder
-3, -2, - 1	0 (default)	+1, +2, +3

Copy Channel

Copy this channel and all its settings into the buffer. When a channel is stored in the buffer, the scanner adds *Paste Channel* to the bottom of the *Program Channel* menu whenever you are editing a compatible system (that is, a system that is the same type as the one you copied the channel from).

Delete Channel

Delete this frequency or channel and all associated settings.

New Channel

Create a new channel.

Analog channel options

The following options are available only when the Audio Type is set to *Analog* .

Set CTCSS/DCS

(Conventional systems only) Choose one of the following CTCSS/DSC options for this channel:

Off	The scanner ignores all CTCSS and DCS tones and opens squelch on any signal.
Search	The scanner displays any received CTCSS and DCS tones, but it opens squelch on any signal.
CTCSS	The scanner prompts you to enter a CTCSS code; it will only open squelch if the received signal contains a CTCSS tone that matches the one you enter here.
DCS	The scanner prompts you to enter a DCS code; it will only open squelch if the received signal contains a DCS tone that matches the one you enter here.
Set Lockout	The scanner prompts you to enter a CTCSS or DCS code that you want to lockout for this channel. The scanner will not open squelch if the received signal contains a matching CTCSS or DCS tone.

Digital channel options

The following options are available only when the Audio Type is set to *Digital* .

P25 NAC Option

Choose whether the scanner limits reception to transmissions that include a specific Network Access Code (NAC) for this system or frequency.

- *Search*: The scanner opens squelch for any digital signal, but displays the NAC being used.
- *Set P25 NAC*: The scanner opens squelch only for signals that include the NAC you enter here. Enter a hexadecimal number between *0* and *FFF*.

This page applies to the following scanner(s): [BCD996XT](#) [BCD396XT](#) [Users Guide](#)

The scanner can automatically adjust the volume when it tunes to this channel or frequency. Enter one of the following options:

Softer	No Change	Louder
-3, -2, - 1	0 (default)	+1, +2, +3

System Name:	Medley City Public Safety
Location:	Medley, FL
County:	Dade
System Type:	EDACS SCAT
System Voice:	Analog
Last Updated:	<i>Updated Function Tag assignments for 3 talkgroups</i>
Hits:	1742

System Frequencies

Red (c) are Primary Control Channels | **Blue (a)** are alternate control channels | Click a Site Name for additional site information | Site Map: [FCC Callsigns](#) [RR Locations](#)

Site Name	
000	Police 01 855.13750c

System Talkgroups

Updated in the last 7 days Updated in the last 24 hours [List All](#) in one table [Show New](#) Talkgroups

POLICE Talkgroups ▶

DEC	AFS	Mode	Alpha Tag	Description	Tag
100	00-124	A	DISPATCH	Police Dispatch	Law Dispatch

EDACS SCAT System

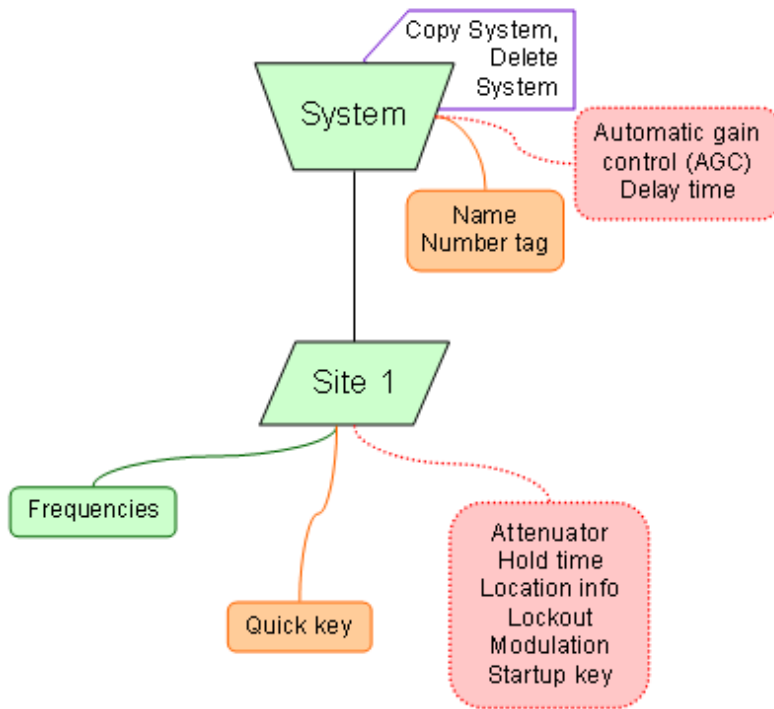

System Layout Legend

Items

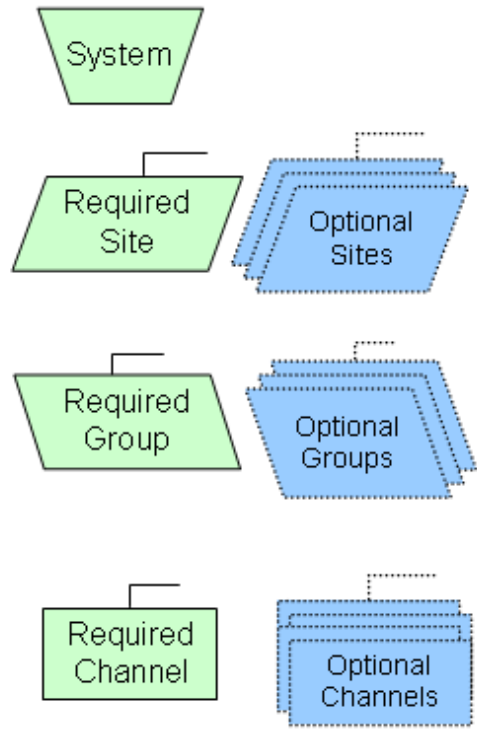

Properties

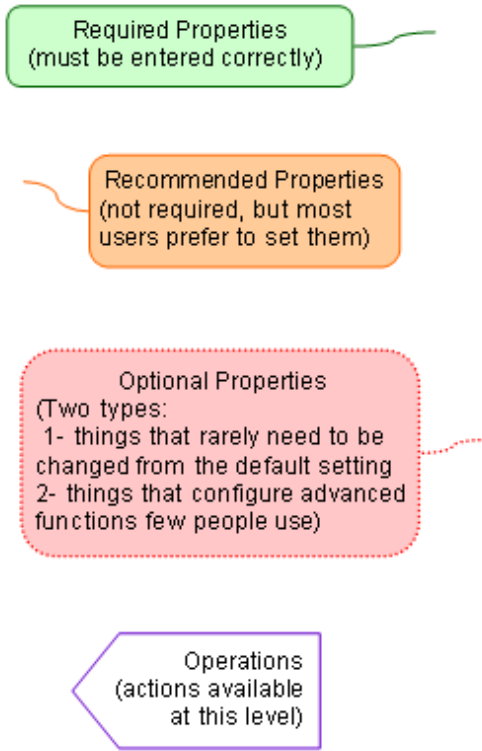

Edit Site

To determine whether the information on this page applies to your scanner, see the tags at the bottom of the page.

When you create a new site, the scanner automatically assigns a default site name using the following pattern

Site XXX-YYY TTT

where *XXX* is a 3-digit system index number, *YYY* is a sequential site number (1 through 256), and *TTT* is one of the following 3-letter type codes:

- *EDC* (any EDACS system)
- *LTR* (any LTR system)
- *MOT* (any Motorola system)
- *P25* (a standard P25 system)
- *1FQ* (a single-frequency P25 system)

- Options available for all sites:
 - [Edit Name](#)
 - [Set Quick Key](#)
 - [Set Startup Key](#)
 - [Set Frequencies](#)
 - [Set Modulation](#)
 - [Set Attenuator](#)
 - [Set Lockout](#)
 - [Set Hold Time](#)
 - [Set LocationInfo](#)
 - [Delete Site](#)
 - [New Site](#)

- Options available for Motorola systems
 - [Edit Band Plan](#)
 - [P25 Waiting Time \(BCD396XT and BCD996XT Only\)](#)
 - [Set C-Ch Only](#)

- Options available for P25 systems (BCD396XT and BCD996XT Only)

- [Edit Band Plan \(P25\)](#)
- [Options available for EDACS systems](#)
 - [Set Site Type](#)

Options available for all sites:

You have the following options for sites:

Edit Name

Enter a name or edit the existing one. Names can be 16 characters long, and they can contain upper and lower case letters, punctuation, and spaces. Turn the **SELECT-VOLUME-SQUELCH** knob on the handheld scanners or the **SCROLL / FUNCTION** knob on mobile scanners to choose the character you want, then press **6** (right cursor) to move the cursor to the next character.

Set Quick Key

Assign this system or site to a Quick Key so you can easily enable or disable it during scanning. Enter a number from 0 to 99; tap **NO** (the decimal point) if you don't want to assign this system or site to a Quick Key. (For more information, see [Quick Keys](#).)

Set Startup Key

Assign this system or site to a Startup Key so you can lock or unlock it during power up. Enter a number from 0 to 9; tap **NO** (the decimal point) if you don't want to assign this system or site to a Startup Key. (For more information, see [Startup Keys](#).)

[Set Frequencies](#)

Use this menu to program frequencies for this site.

Set Modulation

Select what type of modulation the scanner should use for this frequency or channel. (Only the modulation types available for this frequency or channel are displayed.)

Auto	The scanner uses the default modulation type for this frequency's band.
NFM	The scanner treats the frequency as a Narrowband FM band.
FM	The scanner treats the frequency as an FM band.

Set Attenuator

Turn on attenuation to reduce the signal strength by 20 dB. You can turn on attenuation for individual frequencies and channels or for entire sites. If you turn on attenuation for a site, all frequencies within that site will be attenuated.

Set Lockout

Decide whether you want to lock out the site so the scanner will ignore it during Scan and Search modes. Choose one of the following options:

- Unlocked: The site is not locked out.
- Temporary L/O: The site is locked out until you turn the scanner off and back on.
- Lockout: The site is permanently locked out.

Set Hold Time

Set the minimum number of seconds the scanner should spend checking this system or site even if there is no traffic on any channel. (The scanner always checks each channel in a system or site once even if the hold time is set to 0 seconds.) Select the number of seconds from 0 through 255 (2 is the default).

[Set LocationInfo](#)

Use this menu to program location information for this site.

Delete Site

Delete this site and all its settings; this includes any frequencies.

New Site

Create a new site.

Options available for Motorola systems

[Edit Band Plan](#)

[P25 Waiting Time](#) ([BCD396XT](#) and [BCD996XT](#) Only)

Set C-Ch Only

If you activate this feature, you can monitor this system by programming only the control channel (instead of programming the control channel and all the voice channels).

When you use C-Ch Only, you will not be able to use the Trunking Channel Activity Indicators, but you will save memory.

Options available for P25 systems ([BCD396XT](#) and [BCD996XT](#) Only)

Edit Band Plan (P25)

Most P25 systems include the band plan information in the control channel data. However, if a system does not include this information, you can program it manually.

The scanner will prompt you for the following information:

Band plan number	Select one of the 16 available band plan slots.
Input Base Freq	Enter the lower limit of the band frequency. Valid frequencies are between 25.00000 MHz and 1300.00000 MHz at each 5.0 Hz step (25.000000 MHz, 25.000005 MHz, 25.000010 MHz, etc.).

Input Spacing	Enter the number of kHz between each channel. Valid spacings range between 125 kHz and 128 kHz at each 125 Hz step (125.000 kHz, 125.125 kHz, 125.250 kHz, etc.)
----------------------	--

When you're finished, the scanner renames the band plan in the following pattern:

{band plan number} : {base frequency} / {spacing}

So a band plan label of *6:534.02585/127.750* means this is band plan number 6, with a base frequency of 534.02585 MHz and 127.750 kHz between each channel.

Options available for EDACS systems

Set Site Type

Select *Wide (standard)* or *Narrow* according to the EDACS site type.

This page applies to the following scanner(s): [BCD996XT](#) [BCT15X](#) [BCD396XT](#)
[BC346XT Users Guide](#)

Set Frequencies

To determine whether the information on this page applies to your scanner, see the tags at the bottom of the page.

This menu lets you create frequencies and edit existing ones. All existing frequencies are listed in the order they were created: select the frequency you want to edit, or select New Frequency to create a new one. When creating frequencies, keep the following rules in mind:

- You can't duplicate frequencies within a site.
- You can store at least 500 frequencies per site.
- You can store up to 1000 frequencies per site, depending on the number of TGID in the entire system.

- [Set Frequencies](#)
 - [Edit Frequency](#)
 - [Set Lockout](#)
 - [Delete Frequency](#)
 - [New Frequency](#)
- [LTR and EDACS system options](#)
 - [LCN \(Logical Channel Number\)](#)
- [EDACS SCAT system options](#)
 - [Set Number Tag](#)
 - [Volume Offset](#)
 - [Set Record \(BCD996XT and BCT15X Only\)](#)

Edit Frequency

Enter a valid frequency for this band. If the frequency is invalid or if it already exists, the scanner sounds an error tone and prompts you to re-enter the frequency.

Set Lockout

Decide whether you want to lock out a system, site, or channel so the scanner will ignore it during Scan and Search modes. If you lock out a system or site, all channels within

that system or site will be locked out. Choose one of the following options:

- *Unlocked*: The system, site, or channel is not locked out.
- *Temporary L/O*: The system, site or channel is locked out until you turn the scanner off and back on.
- *Lockout*: The system, site, or channel is permanently locked out.

Delete Frequency

Delete this frequency or channel and all associated settings.

New Frequency

Create a new frequency.

LTR and EDACS system options

When you're editing site frequencies within an LTR or EDACS wide or narrow system, you have the following additional options:

LCN (Logical Channel Number)

When you enter a new frequency or edit an existing frequency, the scanner prompts you enter a logical channel number (LCN). Enter a number from 1 through 20 for an LTR system or a number from 1 through 30 for an EDACS wide or narrow system.

EDACS SCAT system options

When you're editing site frequencies within an EDACS SCAT system, you have the following additional options:

Set Number Tag

Assign a number to this system or channel that you can use to tune directly to a specific channel. Choose a number from 0 to 999. (For more information, see [Number Tags](#).)

Volume Offset

The scanner can automatically adjust the volume when it tunes to this channel or frequency. Enter one of the following options:

Softer	No Change	Louder
-3, -2, - 1	0 (default)	+1, +2, +3

Set Record (BCD996XT and BCT15X Only)

Turn on this option to have the scanner output transmissions from the RECORD OUT jack.

This page applies to the following scanner(s): [BCD996XT](#) [BCT15X](#) [BCD396XT](#)
[BC346XT Users Guide](#)

System Name:	Irving Public Safety System
Location:	Irving, TX
County:	Dallas
System Type:	EDACS Standard
System Voice:	Analog
Last Updated:	11-08-2007 03:40

System Frequencies

Red* are Primary Control Channels **Blue*** are Secondary Control Channels

Site	Description							
001	Primary	01-868.53750*	02-868.08750	03-868.58750	04-855.46250	05-868.63750	06-857.21250	07-868.73750
		08-868.83750	09-868.58750	10-868.91250				

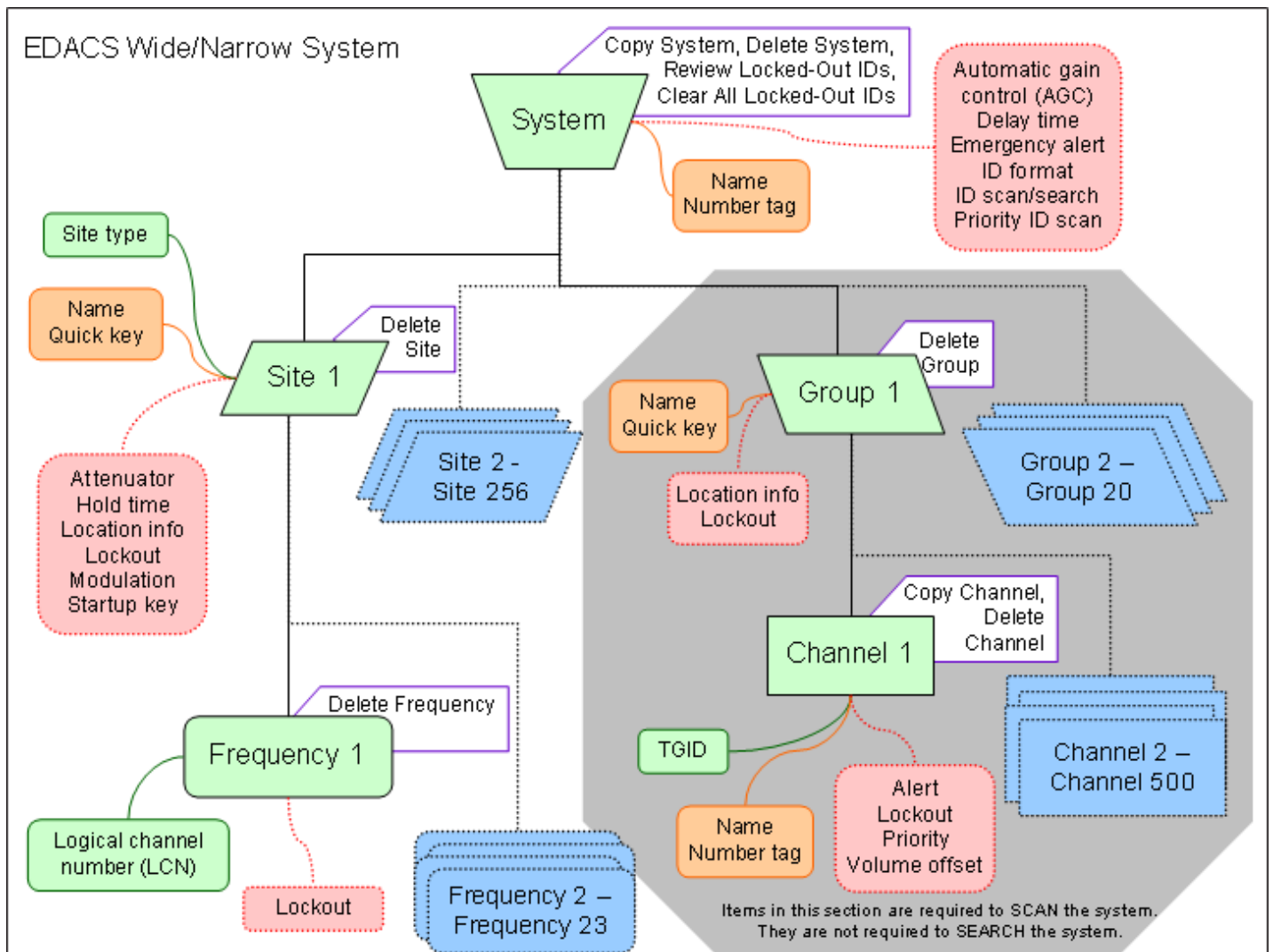

Scan mode

To determine whether the information on this page applies to your scanner, see the tags at the bottom of the page.

- [Scanning vs. Searching](#)
 - [Scanning trunked systems](#)
 - [Searching trunked systems](#)
- [Default Scan Mode](#)
- [Locked Items](#)
- [Key operation in Scan mode](#)
 - [Special keys](#)
 - [Keypad controls](#)
- [Key operation in Search mode](#)
 - [Special keys](#)
 - [Keypad controls](#)

Scanning vs. Searching

Scan and Search mode have very similar operations. In both Scan and Search modes, the scanner steps through a set of frequencies and checks for activity. For Scan mode, you program each individual frequency or Talk Group ID you want the scanner to check; for Search mode, you designate a range of frequencies, and the scanner will check each individual frequency that falls within that range.

With trunked systems, Scan mode and Search mode are very similar, so the scanner can combine the two in a single operation, switching from one to the other depending on the settings of each individual system:

Scanning trunked systems

- The scanner *scans* a system if the *ID Scan Search* option is set to *ID Scan*
- The scanner only checks for activity on unlocked Talk Group IDs *that are programmed for this system*.
- If any programmed Talk Group ID becomes active, the scanner switches to the voice channel and monitors the transmission until it ends or until the *Delay Time* expires.

- The scanner checks each unlocked Talk Group ID at least once; if the hold time has expired, it moves on to the next system.

Searching trunked systems

- The scanner *searches* a system if the *ID Scan Search* option is set to *ID Search* .
- When any Talk Group ID becomes active, the scanner checks to see if that ID is locked out.
- If the ID is unlocked, the scanner switches to the voice channel and monitors the transmission until it ends or until the *Delay Time* expires.
- The scanner monitors the system until the hold time expires, then moves on to the next system.

Default Scan Mode

In the default Scan mode, the scanner checks frequencies in the following order:

1. Scans or searches any unlocked systems programmed to system Quick Keys (SQKs) in ascending order starting with the system or site assigned to SQK #1.
2. *In the system, the scanner first checks any unlocked groups assigned to group Quick Keys (GQKs) in ascending order starting with the system or site assigned to SQK #1 (through GQK #0).
3. *The scanner then checks any remaining unlocked groups in that system in the order in which you created them. If none of the groups in the system have been assigned to GQKs, the scanner checks all unlocked groups in the order in which you created them.
4. *The scanner does not check systems if the SQK is disabled off.
5. *The scanner does not check groups if the GQK is turned off.
6. Scans any remaining unlocked conventional systems (not assigned to an SQK) in alphabetical order based on the system's Name. (The scanner checks groups within each system as described in step 1.)
7. Checks all unlocked trunked systems (not assigned to an SQK) in alphabetical order based on the system's Name. (The scanner checks groups within each system as described in step 1.)
8. Searches through the designated general service frequencies (Public safety, Military, Air, etc.).
9. Searches through any unlocked frequencies saved in the Custom Search list.
10. Checks any frequencies saved in the Close Call Hits list.

Locked Items

The scanner does not check locked out items in either scanning or searching:



- A *system* or *site* is considered locked if
 - its SQK is turned off
 - its [Set Lockout](#) field is set to *Locked Out* or *Temporary L/O*
- A *group* is considered locked if
 - the system or site containing it is locked
 - its GQK is turned off
 - its [Set Lockout](#) field is set to *Locked Out* or *Temporary L/O*
- A *channel* or *frequency* is considered locked if
 - the group containing it is locked
 - its [Set Lockout](#) field is set to *Locked Out* or *Temporary L/O*

Key operation in Scan mode



Special keys

- Turn the **SELECT-VOLUME-SCROLL** knob to change the direction of the scan.
- While monitoring a channel, turn the **SELECT-VOLUME-SCROLL** knob to resume scanning.
- **FUNCTION** + turn the **SELECT-VOLUME-SCROLL** knob to select a system.
The scanner starts scanning at the system you select here.
- **FUNCTION** + tap **MENU** to edit the current system.

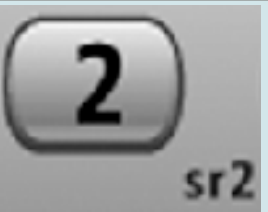
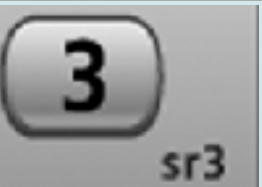
Keypad controls

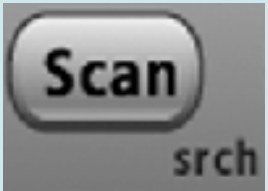
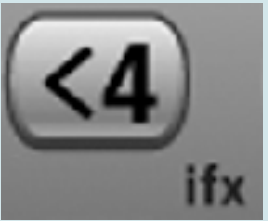
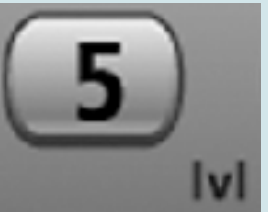
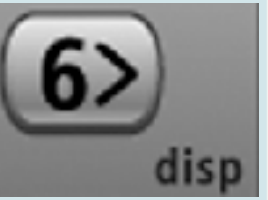
Key Name (2nd operation)				
Action On	HOLD (Close Call)	1 (Search 1)	2 (Search 2)	3 (Search 3)
Tap	Enter Hold mode (the scanner opens squelch).	Disable the systems or sites assigned to this System/ Site Quick Key (SQK). Tap again to enable.		

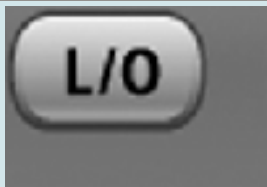
Press & Hold	Scan the current system only. Press & hold again to return to normal scan.	NA	NA	NA
FUNCTION + Tap	Toggle Close Call Modes	Disable the channel groups assigned to this Group Quick Key (GQK). Tap again to enable.		
FUNCTION + Press & hold	Enter Close Call Only mode.	NA	NA	NA
Key Name (2nd operation)				
Action on:	Scan (Search)	4 (IF exchange)	5 (Volume offset)	6 (Display mode)
Tap	Resume scanning.	Disable the systems or sites assigned to this System/ Site Quick Key (SQK). Tap again to enable.		
FUNCTION + Tap	When scanning a conventional system, display the Quick Search prompt (enter Search mode). When scanning a trunked system, switch between ID Scan and ID Search.	Disable the channel groups assigned to this Group Quick Key (GQK). Tap again to enable.		

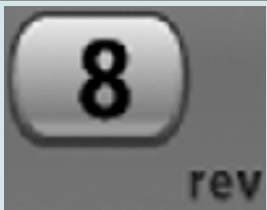
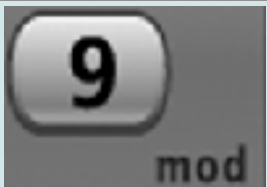
Key Name (2nd operation) Action on:	 Lockout	 7 (Attenuation)	 8 (Reverse freq.)	 9 (Modulation)
Tap	Temporarily lock out the current channel, frequency, or location (until you turn off the scanner).	Disable the systems or sites assigned to this System/ Site Quick Key (SQK). Tap again to enable.		
Double Tap	Permanently lock out the current channel, frequency, or location.	NA	NA	NA
Press & hold	Unlock all channels, groups, and frequencies in the current system.	NA	NA	NA
FUNCTION + Tap	Temporarily lock out the current channel, frequency, or location (until you turn off the scanner).	Disable the channel groups assigned to this Group Quick Key (GQK). Tap again to enable.		
FUNCTION + Double Tap	Permanently lock out the current system or site.	NA	NA	NA
FUNCTION + Press & hold	Unlock all items regardless of type.	NA	NA	NA

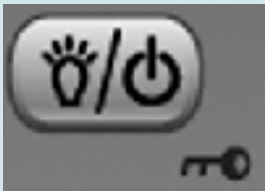
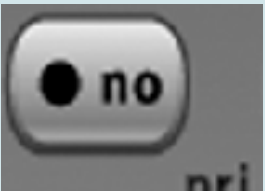
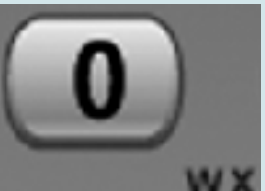
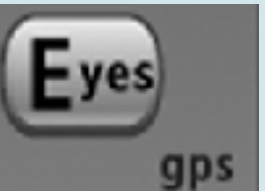
Key Name (2nd operation) Action on:	 Backlight (Power, Lock)	 No (Decimal, Priority)	 0 (Weather)	 Yes (Enter, GPS)
Tap	Turn on the LCD backlight.	Start a 2-digit SQK entry. The next two digits will be treated as the SQK. During a system message: Cancel the message and exit that screen.	Disable the systems or sites assigned to System/Site Quick Key 0. Tap again to enable.	Edit the current channel.
Press & hold	Turn the scanner on or off.	NA	NA	NA
FUNCTION + Tap	Lock or unlock the keypad.	Toggle Priority mode	NA	Enter GPS mode.
FUNCTION + Press & hold	NA	NA	NA	Store the current location information.







Key operation in Search mode



Special keys

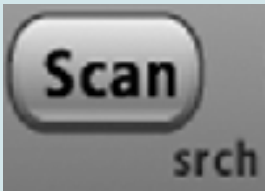

- Turn the **SELECT-VOLUME-SCROLL** knob to change the direction of the search.
- While monitoring a channel, turn the **SELECT-VOLUME-SCROLL** knob to resume searching.
- In Custom Search mode, **FUNCTION** + turn the **SELECT-VOLUME-SCROLL** knob to select a custom search range. The scanner starts at the custom search range you select here.
- **FUNCTION**+ tap **MENU** to go to the *Search for...* menu.

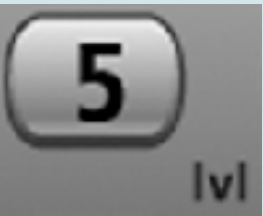
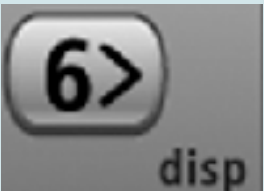
- During a Quick Search, **FUNCTION+** tap **MENU** to go to the *Srch/CloCall Opt* menu.

Keypad controls

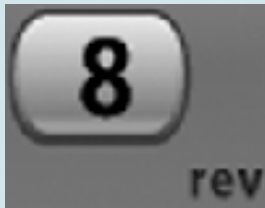
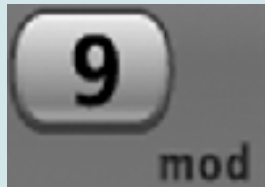
Key Name (2nd operation)				
Action On	HOLD (Close Call)	1 (Search 1)	2 (Search 2)	3 (Search 3)
Tap	Enter Hold mode.	Disable the custom search range assigned to this key. Tap again to enable.		
FUNCTION + Tap	Toggle Close Call modes.	Start the search range assigned to this Search Key.		
FUNCTION + Press & hold	Enter Close Call Only mode.	NA	NA	NA
Key Name (2nd operation)				
Action on:	Scan (Search)	4 (IF exchange)	5 (Volume offset)	6 (Display mode)
Tap	Switch to Scan mode.	Disable the custom search range assigned to this key. Tap again to enable.		
FUNCTION + Tap	Resume searching.	When monitoring a frequency, toggle the IF for that frequency.	NA	Switch the display mode.

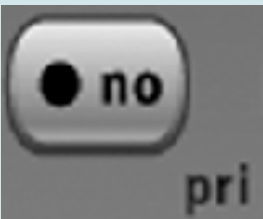
Key Name (2nd operation) Action on:	 Lockout	 7 (Attenuation)	 8 (Reverse freq.)	 9 (Modulation)
Tap	Temporarily lock out the current frequency (until you turn off the scanner).	Disable the custom search range assigned to this key. Tap again to enable.		
Double Tap	Permanently lock out the current frequency.	NA	NA	NA
Press & hold	Unlock all frequencies from search and Close Call modes.	NA	NA	NA
FUNCTION + Tap	Review the list of locked out frequencies.	Toggle the attenuator state for this channel.	NA	Change the modulation.
FUNCTION + Press & hold	NA	Toggle the attenuator state for all signals.	Show the repeater reverse frequency for the current frequency (the scanner returns to the original frequency when you release the key).	NA

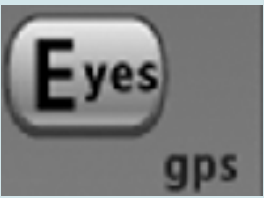
Key Name (2nd operation)				
Action on:	Backlight (Power, Lock)	No (Decimal, Priority)	0 (Weather)	Yes (Enter, GPS)
Tap	Turn on the LCD backlight.	During a system message: Cancel the message and exit that screen.	Disable the search range assigned to this key. Tap again to enable.	Store the current frequency.
Press & hold	Turn the scanner on or off.	NA	NA	NA
FUNCTION + Tap	Lock or unlock the keypad.	NA	Change the WX Alert Priority settings.	Enter GPS mode.
FUNCTION + Press & hold	NA	NA	Enter Weather mode.	NA

This page applies to the following scanner(s): [BCD396XT](#) [BC346XT](#) [Users Guide](#)

Edit Talk Group ID

To determine whether the information on this page applies to your scanner, see the tags at the bottom of the page.

All Talk Group IDs must be in the proper format for each system type.

- [Motorola Type I Systems](#)
- [Motorola Type II Systems](#)
- [P25 Single Frequency Systems \(BCD396XT and BCD996XT only\) or Standard System Trunk Site](#)
- [EDACS Wide or Narrow Systems](#)
 - [AFS format](#)
- [I-Call channel \(Motorola, P25 \(BCD396XT and BCD996XT Only\), or EDACS\)](#)
- [LTR systems](#)

Motorola Type I Systems

Enter the Talk Group ID in the following format:

BFFF-SS

- B = Block # (1 digit)
- F = Fleet # (2-3 digits)
- S = Sub-Fleet # (1-2 digits)

Press the decimal key to enter the hyphen.

(If you try to enter a hexadecimal TGID for a Type I system, the scanner treats the entry as a decimal number.)

Motorola Type II Systems

- Decimal format: Enter the TGID in numbers only, up to 5 digits
- Hexadecimal format: up to 3 characters

Select the first Hex character (0 through F), then move the cursor to the right and select the second character. Press yes when you're finished.

P25 Single Frequency Systems ([BCD396XT](#) and [BCD996XT](#) only) or Standard System Trunk Site

- Decimal format: Enter the TGID in numbers only, up to 8 digits
- Hexadecimal format: up to 6 characters

Select the first Hex character (0 through F), then move the cursor to the right and select the second character. Press yes when you're finished.

EDACS Wide or Narrow Systems

AFS format

Enter the Talk Group ID in the following format:

AA-FFS

- A = Agency # (00 - 15)
- F = Fleet # (00 - 15)
- S = Sub-fleet # (0 - 7)

Press the decimal key to enter the hyphen.

Enter 0 for the Sub-Fleet # to treat it as a wildcard (any Sub-Fleet within that Fleet). You can enter 000 for the Fleet # and Sub-Fleet # to treat them both as wildcards as long as the Agency # is not 00.

I-Call channel (Motorola, P25 ([BCD396XT](#) and [BCD996XT](#) Only), or EDACS)

Enter the Talk Group ID in the following format:

i { ID number }

Press the decimal key to enter the lower-case i, then enter the ID number.

To monitor all iCalls, enter the iCall wildcard i0 in decimal or i in HEX.

LTR systems

Enter the Talk Group ID in the following format:

AHHUUU

- A = Area Code (0 or 1)
- H = Home repeater (01 - 20)
- U = User ID (000 - 254)

This page applies to the following scanner(s): [BCD996XT](#) [BCT15X](#) [BCD396XT](#)
[BC346XT](#) [Users Guide](#)

System Name:	American Airlines Center System							
Location:	Dallas, TX							
County:	Dallas							
System Type:	LTR Standard							
System Voice:	Analog							
Last Updated:	08-15-2004 21:23							
System Frequencies								
Site	Description							
001	Site-1	01-461.50000	02-N/A	03-461.70000	04-N/A	05-462.17500	06-N/A	07-463.87500
		08-N/A	09-N/A	10-N/A	11-464.40000	12-N/A	13-N/A	14-463.33750
		15-N/A	16-464.08750	17-N/A	18-464.18750			

LTR System

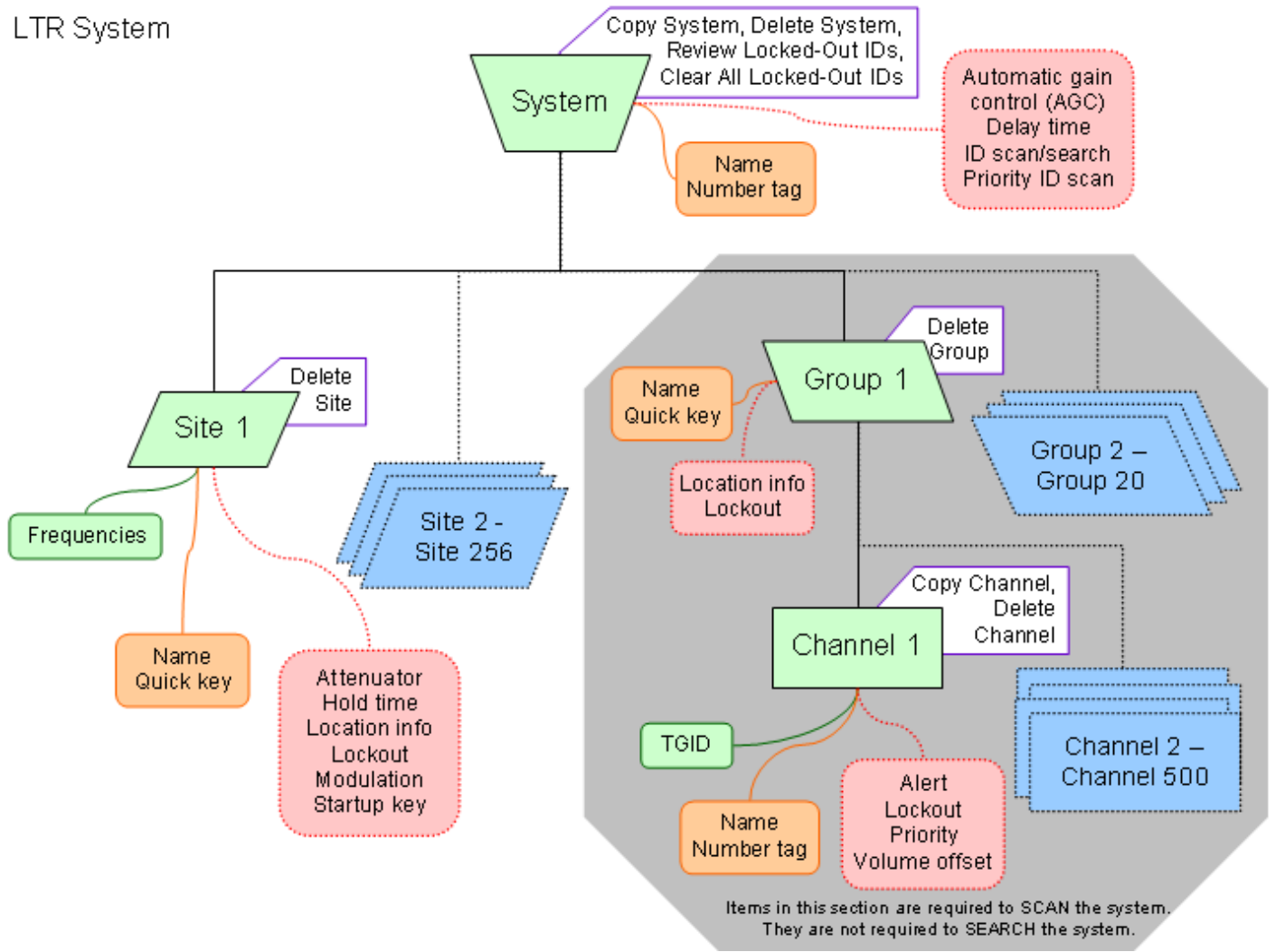

System Name:	Grand Prairie System		
Location:	Grand Prairie, TX		
County:	Dallas		
System Type:	Motorola Type II SmartZone		
System Voice:	Analog and APCO-25 Common Air Interface		
Last Updated:	06-19-2006 16:37		

System ID Table		
Sysid	CT	WACN
2515	105.88	

System Frequencies

Red* are Primary Control Channels **Blue*** are Secondary Control Channels

Site	Description	Freqs								
001	Primary	856.96250	857.96250*	858.96250*	859.96250*	860.96250*	868.23750	868.51250	868.76250	868.96250

System Name:	Arlington System
Location:	Arlington, TX
County:	Tarrant
System Type:	Motorola Type II Smartnet
System Voice:	Analog
Last Updated:	09-12-2006 14:37

System ID Table		
Sysid	CT	WACN
162A	105.88	

System Frequencies

Red* are Primary Control Channels **Blue*** are Secondary Control Channels

Site	Description	Freqs									
001	Primary	856.48750	856.71250	857.48750	857.71250*	858.48750	858.71250*	859.48750	859.71250*	860.48750	
		860.71250*	867.56250	868.26250							

System Name:	United Parcel Service (DFW Airport) System		
Location:	DFW Airport, TX		
County:	2 counties		
System Type:	Motorola Type II Smartnet		
System Voice:	Analog		
Last Updated:	06-04-2007 18:42		

Sysid	CT	WACN
7507	116.13	

Base	Spacing	Offset
461.5000	380	12.5
451.0000	560	12.5

System Frequencies
Red* are Primary Control Channels Blue* are Secondary Control Channels

Site	Description	Freqs								
001	Primary	451.31250	451.66250	451.68750	452.03750	452.53750	452.68750*	452.68750*	462.18750*	462.48750*

System Name:	Staffordshire Fire & Rescue System
Location:	Staffordshire, EN
County:	Staffordshire
System Type:	Motorola Type II Smartnet
System Voice:	Analog
Last Updated:	02-01-2008 11:17

Sysid	CT	WACN
1533		

Base	Spacing	Offset
152.0000	380	12.5
154.0000	461	12.5

System Frequencies

Red* are Primary Control Channels **Blue*** are Secondary Control Channels

Site	Description	Freqs								
001	North Simulcast	153.82500 155.61250	154.08750	154.72500	154.88750	155.07500	155.30000	155.41250*	155.43750	155.56250
002	South Simulcast	152.15000*	152.26250	152.31250	152.53750	152.82500	155.21250	155.52500	155.55000	155.87500
006	Site-6	152.83750 155.81250	154.08750	154.72500	154.88750	155.07500	155.30000	155.41250*	155.43750	155.56250
011	Site-11	152.02500*	154.57500	154.75000						

Motorola System

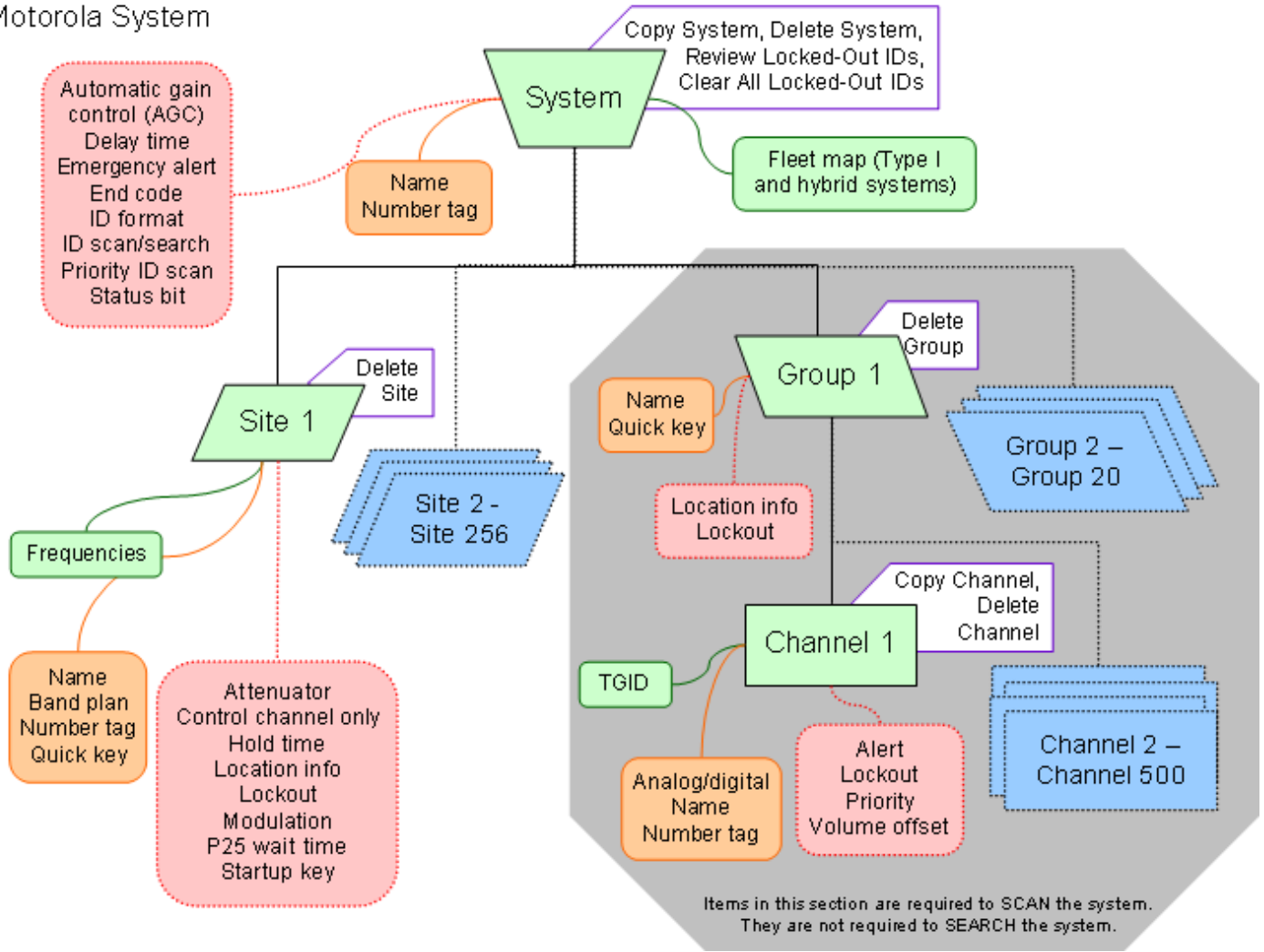

Motorola System Worksheet B (Fleet Maps)

Fleet Map #:	
Block Information:	
Block	Size Code
Block 0	
Block 1	
Block 2	
Block 3	
Block 4	
Block 5	
Block 6	
Block 7	

Fleet Map #:	
Block Information:	
Block	Size Code
Block 0	
Block 1	
Block 2	
Block 3	
Block 4	
Block 5	
Block 6	
Block 7	

Fleet Map #:	
Block Information:	
Block	Size Code
Block 0	
Block 1	
Block 2	
Block 3	
Block 4	
Block 5	
Block 6	
Block 7	

Fleet Map #:	
Block Information:	
Block	Size Code
Block 0	
Block 1	
Block 2	
Block 3	
Block 4	
Block 5	
Block 6	
Block 7	

Fleet Map #:	
Block Information:	
Block	Size Code
Block 0	
Block 1	
Block 2	
Block 3	
Block 4	
Block 5	
Block 6	
Block 7	

Fleet Map #:	
Block Information:	
Block	Size Code
Block 0	
Block 1	
Block 2	
Block 3	
Block 4	
Block 5	
Block 6	
Block 7	

Fleet Map #:	
Block Information:	
Block	Size Code
Block 0	
Block 1	
Block 2	
Block 3	
Block 4	
Block 5	
Block 6	
Block 7	

Fleet Map #:	
Block Information:	
Block	Size Code
Block 0	
Block 1	
Block 2	
Block 3	
Block 4	
Block 5	
Block 6	
Block 7	

Edit Band Plan

(Motorola systems only) The scanner prompts you to choose one of the two standard band plan types: *800/900 Standard* or *800 Splinter*. Choose *Custom* if you need to create your own band plan.

- [Creating a custom band plan](#)
 - [Band plan number](#)
 - [Set Base Freq](#)
 - [Set Offset](#)
 - [Set Spacing](#)
 - [Rebanded Motorola Systems](#)

Creating a custom band plan

You will need to create a custom band plan for a Motorola VHF, UHF, and 800 MHz Rebanded system. When you select *Custom*, the scanner prompts you for the following information:

Band plan number

Select one of the 6 available band plan numbers, from *Band Plan 1* through *Band Plan 6*.

Set Base Freq

1. Input the lower limit of the band frequency.
2. Input the upper limit of the band frequency.

(See [Calculating upper base frequencies](#) for more information.)

Set Offset

Enter the offset.

Set Spacing

Select the number of kHz between each channel. Your options are:

5.00	6.25	10.00	12.50	15.00	18.75	20.00	25.00
30.00	31.25	35.00	37.50	40.00	43.75	45.00	50.00
55.00	56.25	60.00	62.50	65.00	68.75	70.00	75.00
80.00	81.25	85.00	87.50	90.00	93.75	95.00	100.00

Rebanded Motorola Systems

When you create a system that has been rebanded to use the frequencies newly added for use by the FCC, you have the option now of selecting 800MHz Custom as the Motorola system type.

Once you create the system, you can set the custom band plan as follows:

1. Edit System Option --> Edit Band Plan
2. Select the band plan entry to edit.
3. Set each of the following entries for the band plan:
 - a. Set Base Freq (Lower and Upper)
 - b. Set Offset
 - c. Set Spacing

For standard rebanded systems, you need to set Band Plan 1 and Band Plan 2 as:

Band Plan	Base Freq (Lower)	Base Freq (Upper)	Offset	Polarity	Spacing
1	851.025MHz	854.000MHz	440	+	25 kHz
2	851.0125MHz	868.9875MHz	0	+	25 kHz

This page applies to the following scanner(s): [BCD996XT](#) [BCT15X](#) [BCD396XT](#)
[BC346XT Users Guide](#)

System Name:	Austin / Travis County / Williamson County / Middle Rio Grande System
Location:	Austin, TX
County	10 counties
System Type:	Project 25 Standard
System Voice:	APCO-25 Common Air Interface Exclusive
Last Updated:	02-28-2008 09:44

System Frequencies

Red* are Primary Control Channels **Blue*** are Secondary Control Channels

Site	Description	Freqs									
101	Simulcast 1	866.16250*	866.28750*	866.41250*	866.56250*	866.71250	866.81250	866.92500	867.08750	867.11250	
		867.31250	867.33750	867.57500	867.60000	867.82500	867.85000	868.10000	868.12500	868.36250	
		868.42500	868.62500	868.68750	868.95000						
102	Simulcast 2	866.13750*	866.31250*	866.38750*	866.58750*	866.73750	866.83750	867.16250	867.18750	867.41250	
		867.63750	867.68750	867.95000	868.05000	868.27500	868.32500	868.55000	868.57500	868.85000	
103	Marble Falls IR	866.46250	866.88750	867.28750	867.80000*	868.15000	868.75000				
104	Honeycomb IR	867.26250	867.72500*	868.17500	868.77500						
105	Burleson Manor IR	867.87500	868.22500*	868.50000	868.92500						
106	USGS Shingle IR	867.66250	867.92500*	868.40000	868.80000						

P25 Standard System

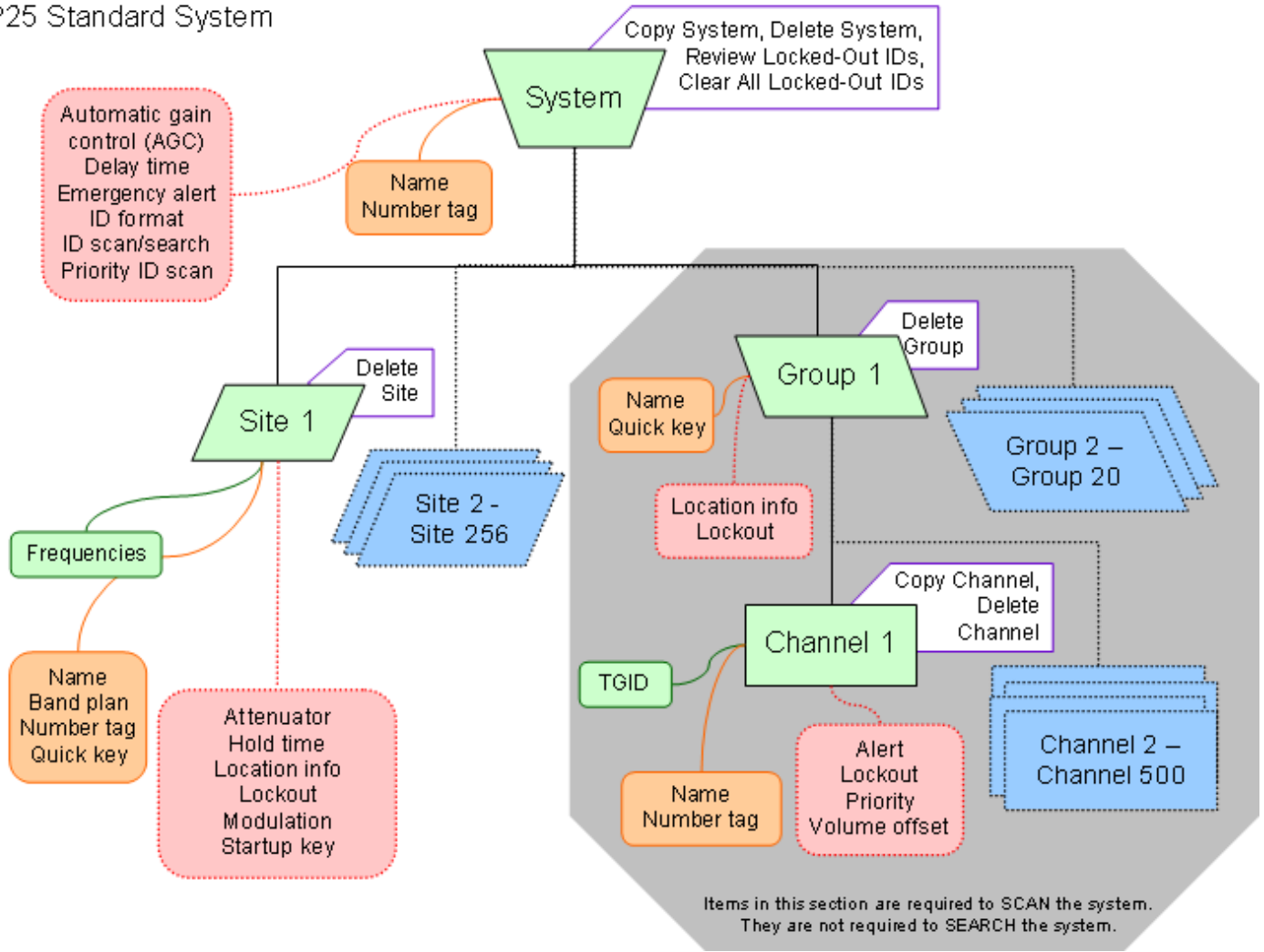

P25 Single Frequency System

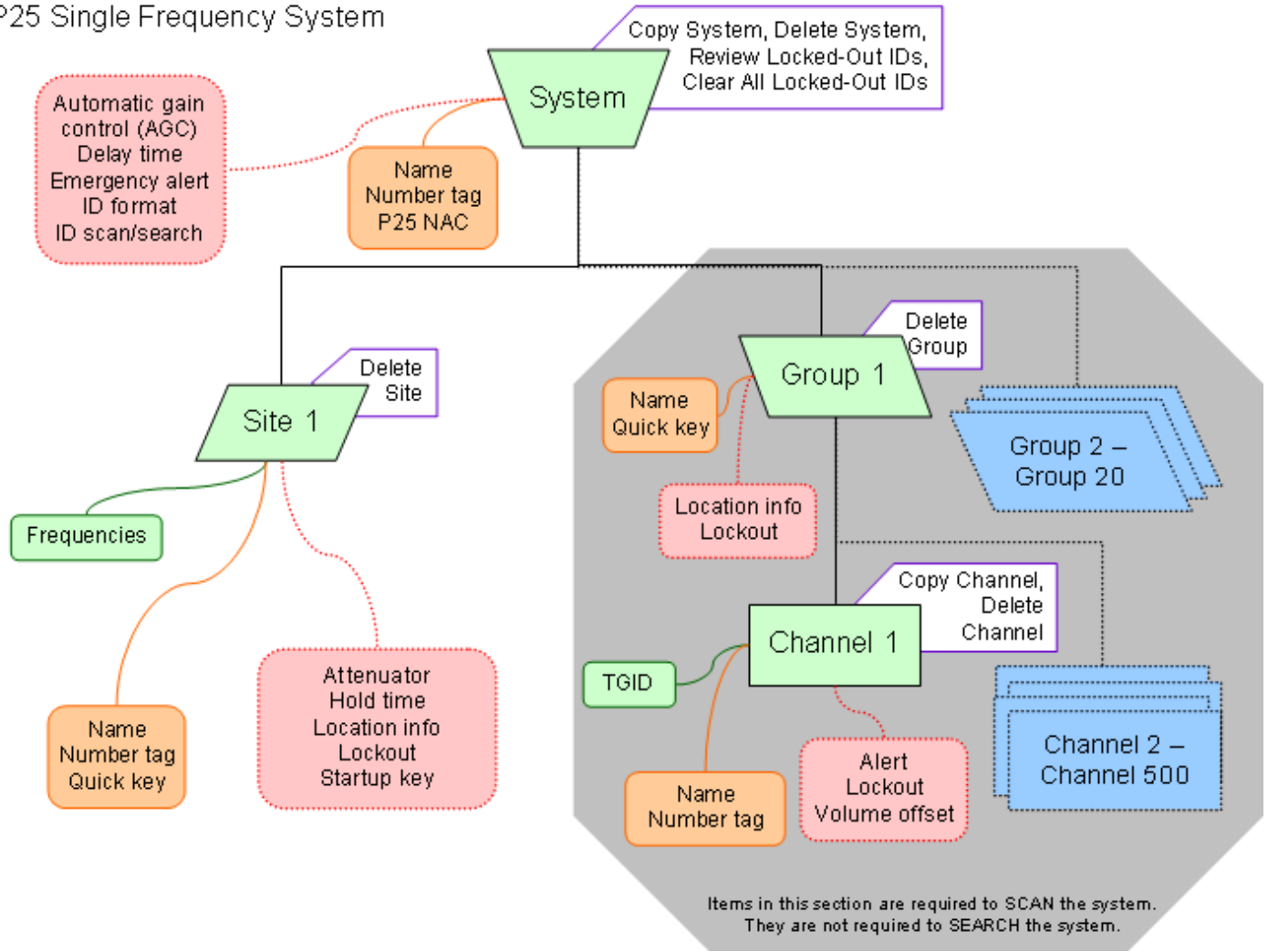









Hold mode









Please note that these pages are meant as general instructions. While most of the information here applies to all scanners, some options may not be available on certain scanner models. Model-specific options are indicated in the text.





Hold mode lets you edit the current frequency, system, site, or channel. You can access these functions by using the different key operations:



- [Key Operation in Hold Mode](#)
- [Reading the displays in Hold mode](#)
 - [Conventional system display](#)
 - [Trunked system display](#)
 - [Service search with scan hold display](#)

Key Operation in Hold Mode

Key Name (2nd operation)	 PRIORITY	 1 (Search 1)	 2 (Search 2)	 3 (Search 3)
Action On				
Tap	Toggle priority mode.	Enter the digit in Direct Entry.		
FUNCTION + Tap	Toggle priority mode.	Start the search range assigned to this Search Key.		
Key Name (2nd operation)	 Weather	 4 (IF exchange)	 5 (Level offset)	 6 (Display mode)
Action on:				
Tap	Toggle Weather Priority Mode	Enter the digit in Direct Entry.		
FUNCTION + Tap	Toggle Weather Priority Mode	Toggle the IF for that the current frequency.	Change the volume offset for the current channel.	Change the display mode.
Press & Hold	Go to Weather Scan mode.	NA	NA	NA

Key Name (2nd operation) Action on:	 GPS	 7 (Attenuation)	 8 (Reverse freq.)	 9 (Modulation)
Tap	Switch to the GPS Navigation display.	Enter the digit in Direct Entry.		
FUNCTION + Tap	Switch to the GPS Navigation display.	Toggle the attenuator state.	NA	Change the modulation.
FUNCTION + Press & hold	NA	Toggle the attenuator state for all signals.	If on a channel that has a valid reverse (input) frequency, show the repeater reverse frequency for the current frequency (the scanner returns to the original frequency when you release the key).	NA
Key Name (2nd operation) Action on:	 Menu	 ./ No (Decimal)	 0	 Yes (Enter)
Tap	Enter the Menu Mode. If you've entered a system number tag/channel number tag in Direct Entry, go to the specified system and channel.	Enter a decimal point, hyphen, or "i" for Direct Entry.	Enter 0 in Direct Entry.	Go to edit mode for the current channel or, if set to a trunked system frequency go to the edit mode for the system.
FUNCTION + Tap	Enter the Menu for the current system or search range.	NA	NA	NA

Key Name (2nd operation) Action on:	 SQUELCH	 VOLUME	 SCAN/SEARCH	 HOLD/RESUME
Rotate	Adjust Squelch.	Adjust volume. Turn fully counterclockwise past click to turn off scanner.	NA	NA
Tap	Change Close Call mode.	Change backlight level.	Resume scanning.	Resume scanning.
Press & Hold	Go to Close Call Only mode.	NA	NA	Hold on the current system and resume scanning.
FUNCTION + Tap	Go to Tone-Out Mode.	Go to P25 fine-tune mode.	Go to the Quick Search prompt.	NA

Key Name (2nd operation) Action on:	 LOCKOUT	 SCROLL - FUNCTION
Rotate	NA	Scroll through channels.
Function + Rotate	NA	Scroll through systems.

Tap	Temporary lockout the current channel. If the current channel is temporarily or permanently locked out, unlock it.	Activate the FUNCTION mode for the next keypress.
Function + Tap	Temporarily lockout the current system. If the current system is temporarily or permanently locked out, unlock it.	NA
Double Tap	Permanently lockout the current channel.	NA
Function + Double Tap	Permanently lockout the current system.	NA
Press & Hold	Unlock all channels in the current system.	"Latch" the FUNCTION mode. Scanner stays on the current system and all keypresses use the FUNCTION mode until you tap the control again.
Function + Press & Hold	Prompt to Unlock All Systems (Y/N)? If you press E/Yes the scanner unlocks and enables all systems, sites, and searches.	NA

Reading the displays in Hold mode

The display information in Hold mode varies depending on the type of system the scanner is Holding on.

Conventional system display

When the scanner is holding on a conventional system, it displays the following screens:

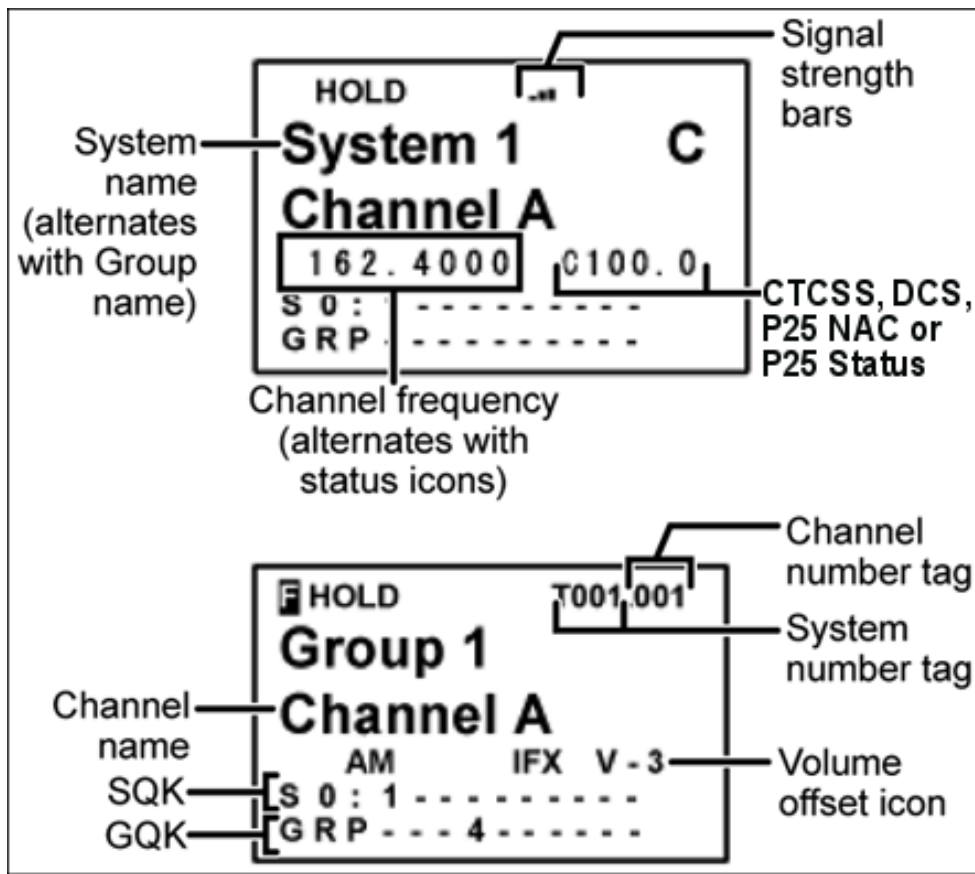

- To see the alternate information on the display at the top, cycle through the display modes.
- To see the display at the bottom of the diagram, tap **FUNCTION**.
- For an explanation of System and Channel Number Tags, see [Number Tags](#).
- For an explanation of the volume offset level, see [Volume Offset](#).

Trunked system display

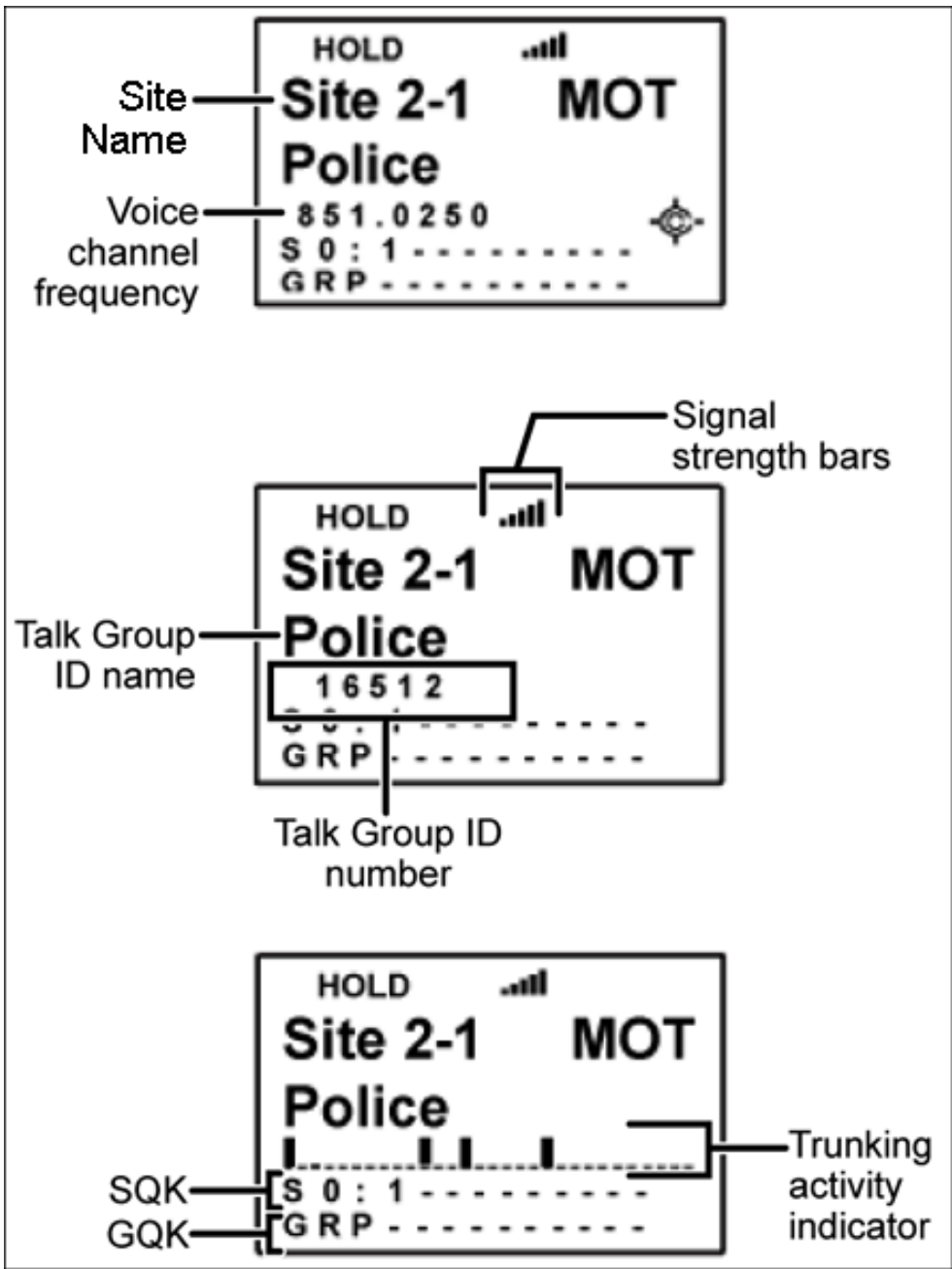

Service search with scan hold display

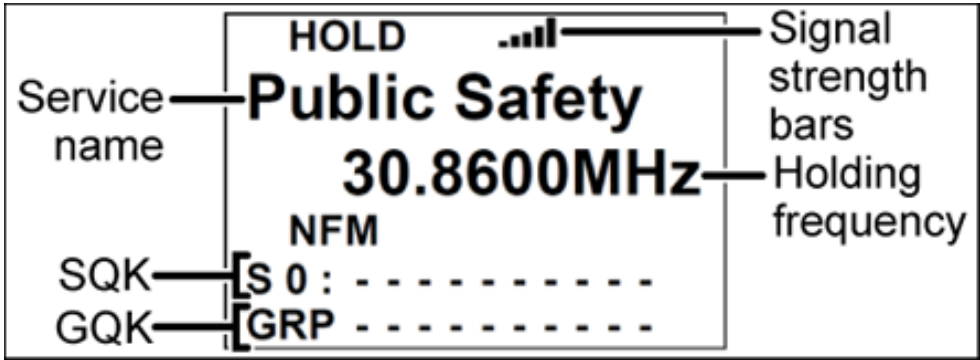

This page applies to the following scanner(s): [BCD996XT Users Guide](#)









Key Safe Mode









Key Safe mode locks out the programming menu and more advanced functions so the user can't accidentally "break" the scanner. This mode is ideal for any situation where you want another person to be able to use the scanner without changing any of the settings.





To turn Key Safe mode on (or off)



- Turn the scanner off.
- Press and hold **FUNCTION** while you turn the scanner back on.
- The scanner display shows *Key Safe Mode On* (or *Key Safe Mode Off*), then returns to the operation it was performing when you turned it off.
- While Key Safe mode is on, **MENU** is disabled along with the key combinations described in the table below.
- When you try to use a disabled key combination, the scanner display shows *Key Safe Mode. Press FUNC while Power On for Full Operation*.

The table below shows which key combinations are disabled and which ones operate normally (depending on the operating mode the scanner is in):

Key Name (2nd operation)	 PRIORITY	 1 (Search 1)	 2 (Search 2)	 3 (Search 3)
Action On				
Tap	Normal Operation			
FUNCTION + Tap while holding	Normal Operation	Disabled		
FUNCTION + Tap while scanning	Normal Operation			
Key Name (2nd operation)	 Weather	 4 (IF exchange)	 5 (Level offset)	 6 (Display mode)
Action on:				
Tap	Normal Operation			

FUNCTION + Tap while holding	Normal Operation	Disabled		Normal Operation
FUNCTION + Tap while scanning	Normal Operation	Normal Operation		
Press & Hold	Disabled	NA	NA	NA
Key Name (2nd operation) Action on:	 GPS	 7 (Attenuation)	 8 (Reverse freq.)	 9 (Modulation)
Tap	Disabled	Normal Operation		
Press & hold	Disabled	NA		
FUNCTION + Tap while holding	Disabled	Disabled	Normal Operation	Disabled
FUNCTION + Tap while scanning	Disabled	Normal Operation		
FUNCTION + Press & hold	NA	Disabled	Normal Operation	NA
Key Name (2nd operation) Action on:	 Menu	 . / No (Decimal)	 0	 Yes (Enter)
Tap	Disabled	Normal Operation		
FUNCTION + Tap	Disabled	Normal Operation		NA

Key Name (2nd operation) Action on:				
	SQUELCH	VOLUME	SCAN/SEARCH	HOLD/RESUME
Rotate	Normal Operation		NA	NA
Tap	Normal Operation		In Close Call, Tone-Out, WX, GPS, and Band Scope modes, this key is disabled. In Search mode, this operates as the Resume function.	Normal Operation
Press & Hold	Disabled	NA	NA	Normal Operation
FUNCTION + Tap	Disabled	NA	Disabled	Normal Operation

Key Name (2nd operation) Action on:		
	LOCKOUT	SCROLL - FUNCTION
Rotate	NA	Normal Operation
Tap	Normal Operation (temporary lockout only)	Normal Operation
Function + Tap	Normal Operation (temporary lockout only)	NA
Press & Hold	Disabled	Normal Operation

This page applies to the following scanner(s): [BCD996XT Users Guide](#)

Scan mode

To determine whether the information on this page applies to your scanner, see the tags at the bottom of the page.

- [Scanning vs. Searching](#)
 - [Scanning trunked systems](#)
 - [Searching trunked systems](#)
- [Default Scan Mode](#)
- [Locked Items](#)
- [Key operation in Scan mode](#)
 - [Special keys](#)
 - [Keypad controls](#)
- [Key operation in Search mode](#)
 - [Special keys](#)
 - [Keypad controls](#)

Scanning vs. Searching

Scan and Search mode have very similar operations. In both Scan and Search modes, the scanner steps through a set of frequencies and checks for activity. For Scan mode, you program each individual frequency or Talk Group ID you want the scanner to check; for Search mode, you designate a range of frequencies, and the scanner will check each individual frequency that falls within that range.

With trunked systems, Scan mode and Search mode are very similar, so the scanner can combine the two in a single operation, switching from one to the other depending on the settings of each individual system:

Scanning trunked systems

- The scanner *scans* a system if the *ID Scan Search* option is set to *ID Scan*
- The scanner only checks for activity on unlocked Talk Group IDs *that are programmed for this system*.
- If any programmed Talk Group ID becomes active, the scanner switches to the voice channel and monitors the transmission until it ends or until the *Delay Time* expires.
- The scanner checks each unlocked Talk Group ID at least once; if the hold time has expired, it moves on to the next system.

Searching trunked systems

- The scanner *searches* a system if the *ID Scan Search* option is set to *ID Search* .
- When any Talk Group ID becomes active, the scanner checks to see if that ID is locked out.
- If the ID is unlocked, the scanner switches to the voice channel and monitors the transmission until it ends or until the *Delay Time* expires.
- The scanner monitors the system until the hold time expires, then moves on to the next system.

Default Scan Mode

In the default Scan mode, the scanner checks frequencies in the following order:

1. Scans or searches any unlocked systems programmed to system Quick Keys (SQKs) in ascending order starting with the system or site assigned to SQK #1.
2. *In the system, the scanner first checks any unlocked groups assigned to group Quick Keys (GQKs) in ascending order starting with the system or site assigned to SQK #1 (through GQK #0).
3. *The scanner then checks any remaining unlocked groups in that system in the order in which you created them. If none of the groups in the system have been assigned to GQKs, the scanner checks all unlocked groups in the order in which you created them.
4. *The scanner does not check systems if the SQK is disabled off.
5. *The scanner does not check groups if the GQK is turned off.
6. Scans any remaining unlocked conventional systems (not assigned to an SQK) in alphabetical order based on the system's Name. (The scanner checks groups within each system as described in step 1.)
7. Checks all unlocked trunked systems (not assigned to an SQK) in alphabetical order based on the system's Name. (The scanner checks groups within each system as described in step 1.)
8. Searches through the designated general service frequencies (Public safety, Military, Air, etc.).
9. Searches through any unlocked frequencies saved in the Custom Search list.
10. Checks any frequencies saved in the Close Call Hits list.

Locked Items

The scanner does not check locked out items in either scanning or searching:











- A *system* or *site* is considered locked if
 - its SQK is turned off
 - its [Set Lockout](#) field is set to *Locked Out* or *Temporary L/O*
- A *group* is considered locked if
 - the system or site containing it is locked
 - its GQK is turned off
 - its [Set Lockout](#) field is set to *Locked Out* or *Temporary L/O*
- A *channel* or *frequency* is considered locked if
 - the group containing it is locked
 - its [Set Lockout](#) field is set to *Locked Out* or *Temporary L/O*





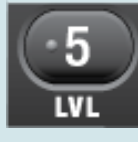
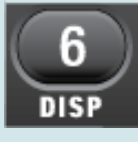



Key operation in Scan mode

Special keys



- Turn the **SCROLL** knob to change the direction of the scan.
- While monitoring a channel, rotate the **SCROLL** knob or press **SCAN** to resume scanning.
- **FUNCTION** + turn the **SCROLL** knob to select a system. The scanner starts scanning at the system you select here.
- **FUNCTION** + tap **MENU** to edit the current system.

Keypad controls

Key Name (2nd operation)	 PRI	 1 (Search 1)	 2 (Search 2)	 3 (Search 3)
Action On				
Tap	Toggle priority modes.	Disable the systems or sites assigned to this System/Site Quick Key (SQK). Tap again to enable.		
FUNCTION + Tap	Toggle priority modes.	Disable the channel groups in the current system assigned to this Group Quick Key (GQK). Tap again to enable.		
Key Name (2nd operation)	 Weather	 4 (IF exchange)	 5 (Level offset)	 6 (Display mode)
Action on:				
Tap	Toggle Weather Alert priority mode.	Disable the systems or sites assigned to this System/Site Quick Key (SQK). Tap again to enable.		
Press & Hold	Weather Scan	NA		
FUNCTION + Tap	Toggle Weather Alert priority Mode.	Disable the channel groups in the current system assigned to this Group Quick Key (GQK). Tap again to enable.		
FUNCTION + Press & Hold	Weather Scan	NA		
Key Name (2nd operation)	 GPS	 7 (Attenuation)	 8 (Reverse freq.)	 9 (Modulation)
Action on:				
Tap	Change to GPS Mode.	Disable the systems or sites assigned to this System/Site Quick Key (SQK). Tap again to enable.		
FUNCTION + Tap	Change to GPS Mode.	Disable the channel groups in the current system assigned to this Group Quick Key (GQK). Tap again to enable.		

Key Name (2nd operation) Action on:	 MENU	 . / No	 0	 Yes (Enter)
Tap	Go to the Menu Mode	Start a 2-digit SQK entry. The next two digits will be treated as the SQK. During a system message: Cancel the message and exit that screen.	Disable the systems or sites assigned to System/Site Quick Key 0. Tap again to enable.	If stopped on a channel, edit the current channel.
FUNCTION + Tap	Go to the editing menu for the current system.	Start a 2-digit SQK entry. The next two digits will be treated as the SQK. During a system message: Cancel the message and exit that screen.	Disable or enable the channel groups in the current system assigned to Group Quick Key 0 (GQK 0). Tap again to enable.	If stopped on a channel, edit the current channel.
Key Name (2nd operation) Action on:	 SQUELCH	 VOLUME	 SCAN/SEARCH	 HOLD/RESUME
Rotate	Adjust Squelch.	Adjust volume. Turn fully counterclockwise past click to turn off scanner.	NA	NA
Tap	Toggle Close Call modes.	Change backlight level.	Resume scanning (if stopped on a channel).	Hold on the current channel.
Press & Hold	Go to Close Call Only mode.	NA	NA	Hold on the current system. If already holding on a system, resume normal scanning.

FUNCTION + Tap	Go to Fire Tone- Out Mode.	Go to the P25 status mode.	When scanning a trunked system, toggle between ID Scan and ID Search mode. When scanning a conventional system, go to Quick Search mode.	Hold on the current channel.
--------------------------	-------------------------------	-------------------------------	--	---------------------------------











Key Name (2nd operation) Action on:	 LOCKOUT	 SCROLL - FUNCTION
Rotate	NA	Change scan direction. If stopped on a channel, resume scanning.
Tap	If stopped on a channel, temporarily lockout the channel.	Activate the FUNCTION mode for the next keypress.
Double Tap	If stopped on a channel, permanently lockout the channel.	NA
Press & Hold	If stopped on a channel, unlock all channels in the current system.	"Latch" the FUNCTION mode. Scanner stays on the current system and all keypresses use the FUNCTION mode until you tap the control again.
FUNCTION + Tap	Temporarily lockout the current system.	NA
FUNCTION + Double Tap	Permanently lockout the current system.	NA
FUNCTION + Press & Hold	Unlock all items, regardless of type.	NA





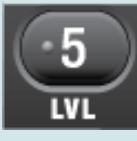
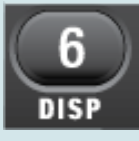



Key operation in Search mode

Special keys



- Turn the **SCROLL** knob to change the direction of the search.
- While monitoring a channel, rotate the **SCROLL** knob to resume searching.
- In Custom Search mode, **FUNCTION** + turn the **SCROLL** knob to select a custom search range. The scanner starts at the custom search range you select here.
- **FUNCTION**+ tap **MENU** to go to the *Search for...* menu.
- During a Quick Search, **FUNCTION**+ tap **MENU** to go to the *Srch/CloCall Opt* menu.

Keypad controls

Key Name (2nd operation)	 PRIORITY	 1 (Search 1)	 2 (Search 2)	 3 (Search 3)
Action On				
Tap	NA	Disable the custom search range assigned to this key. Tap again to enable.		
FUNCTION + Tap	NA	Start the search range assigned to this Search Key.		
Key Name (2nd operation)	 Weather	 4 (IF exchange)	 5 (Level offset)	 6 (Display mode)
Action on:				
Tap	Toggle Weather Priority Mode	Disable the custom search range assigned to this key. Tap again to enable.		
FUNCTION + Tap	Toggle Weather Priority Mode	When monitoring a frequency, toggle the IF for that frequency.	NA	Switch the display mode.
Press & Hold	Go to Weather Scan mode.	NA	NA	NA
Key Name (2nd operation)	 GPS	 7 (Attenuation)	 8 (Reverse freq.)	 9 (Modulation)
Action on:				

Tap	Switch to the GPS Navigation display.	Disable the custom search range assigned to this key. Tap again to enable.		
Press & hold	Unlock all frequencies from search and Close Call modes.	NA	NA	NA
FUNCTION + Tap	Switch to the GPS Navigation display.	Toggle the attenuator state.	NA	Change the modulation.
FUNCTION + Press & hold	NA	Toggle the attenuator state for all signals.	If stopped on a frequency that has a valid reverse (input) frequency, show the repeater reverse frequency for the current frequency (the scanner returns to the original frequency when you release the key).	NA
Key Name (2nd operation) Action on:	 Menu	 ./ No (Decimal)	 0	 Yes (Enter)
Tap	Enter the Menu Mode.	NA	Disable the search range assigned to this key. Tap again to enable.	If stopped on a frequency, store the current frequency.
FUNCTION + Tap	Enter the "Search for..." Menu.	NA	NA	If stopped on a frequency, store the current frequency.
Key Name (2nd operation) Action on:	 SQUELCH	 VOLUME	 SCAN/SEARCH	 HOLD/RESUME

Rotate	Adjust Squelch.	Adjust volume. Turn fully counterclockwise past click to turn off scanner.	NA	NA
Tap	Toggle Close Call modes.	Change backlight level.	Go to Scan mode.	Hold on the current frequency.
Press & Hold	Go to Close Call Only mode.	NA	NA	NA
FUNCTION + Tap	Go to Fire Tone-Out Mode.	Go to P25 status mode.	Resume Searching.	Hold on the current frequency.

Key Name (2nd operation) Action on:	 LOCKOUT	 SCROLL - FUNCTION
Rotate	NA	Change search direction. If stopped on a frequency, resume searching.
Tap	If stopped on a frequency, temporarily lockout the frequency.	Activate the FUNCTION mode for the next keypress.
Double Tap	If stopped on a frequency, permanently lockout the frequency.	NA
FUNCTION + Tap	Review the list of locked out frequencies.	NA
Press & Hold	If stopped on a frequency, unlock all search frequencies.	"Latch" the FUNCTION mode. Scanner stays on the current system and all keypresses use the FUNCTION mode until you tap the control again.

This page applies to the following scanner(s): [BCD996XT Users Guide](#)

BCD996XT Settings

To determine whether the information on this page applies to your scanner, see the tags at the bottom of the page.

- [Set Backlight](#)
 - [Set Dimmer](#)
 - [Auto: Select Polarity](#)
 - [Manual](#)
 - [Set Color](#)
- [Adjust Key Beep](#)
- [Adjust Audio AGC](#)
- [Set Upside-down](#)
- [Adjust Contrast](#)
- [Set C-CH Output](#)
- [Set GPS Format](#)
 - [Set POS Format](#)
 - [Set Time Format](#)
 - [Set Time Zone](#)
 - [Set Unit](#)
- [Set Serial Port](#)
- [Band Defaults](#)
 - [Set Modulation](#)
 - [Set Step](#)
- [P25 LP Filter](#)
- [See Scanner Info](#)
 - [% Memory Used](#)
 - [Firmware Version](#)

Set Backlight

This menu lets you configure the display and key backlight.

Set Dimmer

Selects whether the backlight brightness is set automatically or manually.

Auto: Select Polarity

+ Polarity	The backlight dims when +12V is applied to the orange lead.
- Polarity	The backlight dims when +12V is not being applied to the orange lead.

Manual

Manually select the brightness of the backlight. Your options are high (brightest), middle, and low (dimmiest).

Set Color

Select the color of the backlight. Your options are blue, red, magenta, green, cyan, yellow, and white.

Adjust Key Beep

Select the volume level (Level 1 through Level 15) you want the keybeep to use, or select *Auto* to have the scanner sound the keybeep without changing the volume. If you don't want the scanner to beep when you press the keys, select *Off*.

Adjust Audio AGC

Configure how the scanner handles the *Automatic Gain Control (AGC)* for Analog and Digital signals:

Parameter	Definition	Analog settings	Digital settings

Response Time	How frequently the AGC factor updates. Decrease this value to make AGC respond faster (but this could result in pumping). Increase this value to make AGC respond more slowly.	-4 to +6 (default=0)	-8 to +8 (default=0)
Reference Gain	The reference level that AGC attempts to adjust the volume to. If digital and analog volumes don't match, adjust this parameter.	-5 to +5 (default=0)	-5 to +5 (default=0)
Gain Range	The total dynamic range of the AGC adjustments. A larger value allows a wider variation in volume.	_0_ to 15 (default=6)	NA

Set Upside-down

Lets you invert the display. Useful if you are mounting the scanner in an overhead space.

Adjust Contrast

Select one of the 15 available contrast levels for the display. As you scroll through the options, the display adjusts to the highlighted contrast level; press **YES** when you see the display contrast you want to use.

Set C-CH Output

Choose how you want the scanner to handle control channel data:

- *Off* : The scanner will not output the control channel data.
- *On* : The scanner will output the control channel data.

- *Extend* : The scanner will output the control channel data along with any description.

Set GPS Format

Configure how the scanner displays position coordinates, time, and units during GPS operation:

Set POS Format

Select how the scanner displays longitude and latitude:

- *DMS: DDD° MM' SS.ss* : Display coordinates in degrees (DDD), minutes (MM), and seconds (SS.ss).
- *DEG: DDD.ddddd* : Display coordinates as decimal degrees.

Set Time Format

Select 12H for 12-hour (am/pm) time format or 24H for 24-hour time format.

Set Time Zone

Set the number of hours your local time zone differs from universal time (GMT/UTC). Select from -14 hours to +14 hours in half-hour (0.5 h) increments.

Set Unit

Select the unit used for distance: mile or kilometer (km).

Set Serial Port

Select the port you are adjusting (**Set Front Port** or **Set Rear Port**) Then, set the baud rate for the selected serial port. Choose from *4800, 9600, 19200, 38400, 57600* , or *115200* bps; select *Off* to disable the serial port.

The front port defaults to 115200 bps. The rear port defaults to 4800 bps to maintain compatibility with GPS units.

Band Defaults

Use this menu to change the default modulation and frequency step or spacing used for each band. The scanner displays the list of available bands in the following format:

{Frequency} : {modulation type} / {step}

Select the frequency band you want to edit. The scanner prompts you for the following information:

Set Modulation

Select the type of modulation you want the scanner to use as the default for this band: AM, Narrowband FM (NFM), FM, Wideband FM (WFM), or FM broadcast (FMB).

Set Step

Select the number of kHz between each frequency or channel step: 5.0, 6.25, 7.5, 8.33, 10.0, 12.5, 15.0, 20.0, 25.0, 50.0, or 100.0 kHz.

P25 LP Filter

This setting lets you set the scanner to apply a software filter that removes the 4kHz tone you can hear on some P25 systems. Note that turning on this setting increases the CPU load and could slightly degrade P25 decode performance on some systems.

See Scanner Info

This menu lets you see detailed information about the memory and firmware.

% Memory Used

See the percent of overall memory used (*Memory Used*) along with the number of programmed *Systems*, *Sites* , and channels (*CHN*) and the percent of available memory positions used for each.

Firmware Version

See the firmware version (*Version*), the electronic serial number (*SN*), checksum (*SUM*), and major firmware version number (*M-Ver*) of the scanner.

This page applies to the following scanner(s): [BCD996XT Users Guide](#)

Calculating upper base frequencies

Custom Band Plans (800 Custom, VHF, UHF) require that you enter both a lower and an upper base frequency value. Here's how to determine these values.

The *Lower Base Frequency* (or *Base*) is always the base frequency as provided in the RRDB. The *Upper Base Frequency* is calculated from the following formulas:

For sites with a single band plan:

$$Base + ((759 - Offset) \times Step)$$

Where:

- *Base* = the lower base frequency listed in RRDB.
- *Offset* = the offset for this entry.
- *Step* = the step for this entry.

For sites with multiple band plans:

$$Upper\ Base_n = Base_n + (Offset_{n+1} - 1 - Offset_n) \times Step_n$$

Where:

- *Base_n* is the lower base frequency for the entry.
- *Offset_{n+1}* is the Offset for the next band plan (for the last table, use 760)
- *Offset_n* is the offset for this band plan
- *Step_n* is the step for this band.

For example:

Custom Frequency Table

<u>Entry</u>	<u>Base</u>	<u>Spacing</u>	<u>Offset</u>
A	155.4150	15.0	380
B	157.2000	12.5	436
C	157.4700	15.0	454

Plugging these values into our formula, we get:

<i>For entry A:</i>					
Upper Base _A	=	$Base_A +$	$(Offset_B -$	$-$	$\times Step_A$
			1	$Offset_A)$	
Upper Base _A	=	155.415 MHz	(436 - 1	- 380)	× 15kHz
		+			
Upper Base _A	=	155.415 MHz	55		× 0.015 MHz
		+			
Upper Base _A	=	155.415 MHz	0.825 MHz		
		+			
Upper Base _A	=	156.240 MHz			

<i>For entry B:</i>					
Upper Base _B	=	$Base_B +$	$(Offset_C -$	$-$	$\times Step_B$
			1	$Offset_B)$	

Upper Base _B	=	157.200 MHz +	(454 – 1	– 436)	× 12.5 kHz
Upper Base _B	=	157.200 MHz +	17		× 0.0125 MHz
Upper Base _B	=	157.200 MHz +	0.2125 MHz		
Upper Base _B	=	157.4125 MHz			

<i>For entry C:</i>					
Upper Base _C	=	$Base_C +$	$(Offset_{C+1} -$	$-$	$× Step_C$
			1	$Offset_C)$	
Upper Base _C	=	157.470 MHz +	(760 – 1	– 454)	× 15 kHz
Upper Base _C	=	157.470 MHz +	305		× 0.015 MHz
Upper Base _C	=	157.470 MHz +	4.575 MHz		
Upper Base _C	=	162.045 MHz			

([Click here](#) to download a spreadsheet that will do all the math for you.)

This page applies to the following scanner(s): [BCD996XT](#) [BCT15X](#) [BCD396XT](#) [BC346XT](#) [Users Guide](#)

Close Call

To determine whether the information on this page applies to your scanner, see the tags at the bottom of the page.

The Close Call (CC) feature searches for signals that are stronger than other signals on the band (indicating the transmitter is probably somewhere close by). This menu lets you change the operation settings of the close call feature; you can change the overall close call options through the [Srch/CloCall Opt](#) menu.

- [Close Call Only](#)
- [CC Auto Store](#)
- [Hits with Scan](#)
 - [Set Quick Key](#)
 - [Set Number Tag](#)
 - [Set Lockout](#)
 - [Set Hold Time](#)
- [Set CC Mode](#)
- [Set CC Override](#)
- [Set CC Alert](#)
 - [Set Alert Tone](#)
 - [Set Alert Light](#)
 - [Set CC Pause](#)
- [Set CC Bands](#)

Close Call Only

Search the selected bands for close call hits; the scanner stops all other scanning for a close call only search.

CC Auto Store

Start a close call search. When a close call hit is detected, the scanner stores that frequency in the system named *Close Call* in the *Found Channels* group. The scanner saves found channels until it reaches the number set in the *Max Auto Store* setting on the

[Srch/CloCall Opt](#) menu.

Hits with Scan

The scanner stores the 10 most recent close call hits to a temporary system; you can set the options for this temporary system, just like you can for permanent systems. The scanner deletes the 10 saved frequencies in this temporary system when you turn the power off. If you want to save any of these frequencies permanently, you need to store them to a programmed system or use the CC Auto Store feature.

Set Quick Key

Assign this system or site to a Quick Key so you can easily enable or disable it during scanning. Enter a number from 0 to 99; tap NO (the decimal point) if you don't want to assign this system or site to a Quick Key. (For more information, see [Quick Keys](#).)

Set Number Tag

Assign a number to this system you can use to tune directly to the system. Choose a number from 0 to 999. (For more information, see [Number Tags](#).) Note that you can only set a system number tag for the Close Call system.

Set Lockout

Decide whether you want to lock out the system so the scanner will ignore it during Scan and Search modes. If you lock out the system none of the found channels will be scanned conventionally.

Unlocked: The system is not locked out.

Temporary L/O: The system is locked out until you turn the scanner off and back on.

Lockout: The system is permanently locked out.

Set Hold Time

Set the minimum number of seconds the scanner should spend checking this system or

site even if there is no traffic on any channel. (The scanner always checks each channel in a system or site once even if the hold time is set to 0 seconds.) Select the number of seconds from 0 through 255 (2 is the default).

Set CC Mode

Choose whether scanner runs close call checks in the background, while you're performing other scans or searches. (The scanner never runs close call checks when you're in weather mode or tone-out mode.)

- *Off*: The scanner does not run close call checks in the background.
- *CC DND*: The scanner runs close call checks every 2 seconds, but it will not leave an active channel for a close call check.
- *CC Pri*: The scanner runs close call checks every 2 seconds, even if the current channel is active. The scanner runs the close call check even while you are monitoring a transmission.

Set CC Override

Choose *On* if you want the scanner to stop its current operation and automatically jump to the frequency when it detects a close call hit. Choose *Off* if you want the scanner to alert you to the close call hit and prompt you to change frequency; if you choose not to change frequency, the scanner times out and returns to its previous operation.

Set CC Alert

Decide whether the scanner triggers an alert tone and light when it detects a close call hit. (Compare this to the system setting [Emergency Alert](#), which triggers a tone and light when a Talk Group contains an emergency flag.) The available options for [Set Alert Tone](#) and [Set Alert Light](#) are common to both types of alerts.

[Set Alert Tone](#)

[Set Alert Light](#)

Set CC Pause

Choose how long you want the scanner to pause on a close call hit before going back to its previous operation; this setting only applies when the Set CC Override feature is turned off. Choose a pause time of 3, 5, 10, 15, 30, 45, or 60 seconds. If you want the scanner to wait for your input whenever it detects a close call hit, select Infinite.

Set CC Bands

Choose whether you want the scanner to search for close call hits on the frequency bands listed below. Select each band you want to search, then press **YES** to turn that band *On* . The scanner only searches for close call hits on bands that are turned on.

<u>Band</u>	<u>BCD396XT and BCD996XT frequencies</u>	<u>BC346XT and BCT15X frequencies</u>
<i>VHF Low 1</i>	25.0000–53.9800 MHz	25.0000–53.9800 MHz
<i>VHF Low 2</i>	54.0000–107.9000 MHz	54.0000–107.9000 MHz
<i>Air Band</i>	108.0000–136.9916 MHz	108.0000–136.9916 MHz
<i>VHF High 1</i>	137.0000–224.9800 MHz	137.0000–224.9800 MHz
<i>VHF High 2</i>	225.0000–319.9500 MHz	Not available
<i>UHF</i>	320.0000–512.0000 MHz	400.0000–512.0000 MHz
<i>800 MHz +</i>	758.0000–823.9875 MHz 849.0125–868.9875 MHz 894.0125–960.0000 MHz 1240.0000–1300.0000 MHz	806.0000–823.9875 MHz 849.0125–868.9875 MHz 894.0125–960.0000 MHz 1240.0000–1300.0000 MHz

This page applies to the following scanner(s): [BCD996XT](#) [BCT15X](#) [BCD396XT](#)
[BC346XT Users Guide](#)

Introduction to SAME messages

Hazard alerts are transmitted with Specific Area Message Encoding (SAME) data, which includes:

- Nature of the alert
- Hazard level
- Affected counties
- Expiration time

Receivers that can decode the SAME data can filter alerts by area and/or hazard level and show details about the alert on a display. For a table of all the alerts and the code meanings, [click here](#).

FIPS Codes

The US National Weather Service uses 6-digit Federal Information Processing System (FIPS) codes to issue hazard alerts in specific areas. You can choose which areas you want to hear alerts for by programming the appropriate FIPS codes into your receiver: the receiver only sounds the alert tone if an incoming FIPS code matches one of the areas you entered.

Each county (or parish, etc.) is designated by a 5-digit FIPS code; parts of a county are marked by a section code inserted at the front:

<u>Code</u>	<u>Country area</u>
0	Entire County (default)
1	Northwest
2	North Central
3	Northeast
4	West Central

5	Central
6	East Central
7	Southwest
8	South Central
9	Southeast

- Very few counties are large enough to use the section code; most counties just code all hazards as 0 for the entire county.
- If you use 0 for the section code, you will receive all alerts for that county regardless of the transmitted section code (because the entire county includes all sections of the county).
- If you use any other section code, you will only receive alerts for that section and entire county alerts. For example, if you program the section code as 5 (Central), you will receive alerts transmitted with section code 0 and section code 5. You will not receive alerts that are transmitted with section codes 1 through 4 or 6 through 9.

For a complete index of the FIPS codes used in SAME broadcasts, see the [United States and Territories Table](#) at the National Weather Radio website, or call **1-888-NWR-SAME (1-888-697-7263)** for a voice menu.

This page applies to the following scanner(s): [BCD996XT](#) [BCT15X](#) [BCD396XT](#) [BC346XT](#) [Users Guide](#)

Wired Clone

This feature allows you to copy all the settings from one scanner to another of the same model:

1. Use one of the included data cables to connect the two scanners. Plug the DB9 end into the rear port of one scanner and the other end into the front port of the other scanner.
2. On the scanner you want to copy from, go to the *Wired Clone* menu and select *Master* then select the port (*Front Port* or *Rear Port*) that the cable is connected to on that scanner .
3. On the scanner you want to copy to, go to the *Wired Clone* menu and select *Slave* then select the port (*Front Port* or *Rear Port*) that the cable is connected to on that scanner .

The master scanner checks to make sure the slave is properly connected and ready to receive, then begins the data transfer. **Do not disconnect the data cable or turn off either scanner during the transfer.**

When the transfer is finished, both scanners display a *Complete* message. Reboot the slave scanner to load the new settings.

All settings and data saved on the Slave scanner will be erased!

This page applies to the following scanner(s): [BCD996XT](#) [BCT15X](#) [Users Guide](#)

Motorola fleet maps

- [Preset Fleet Maps](#)
- [Custom Fleet Maps](#)
- [How Fleet Maps Work](#)
 - [Blocks](#)
 - [Size Codes](#)

Preset Fleet Maps

The scanner contains 16 pre-programmed fleet maps you can select. The table below gives the size code for each block of the preset fleet maps:

Block number	0	1	2	3	4	5	6	7
Preset 1	11	11	11	11	11	11	11	11
Preset 2	4	4	4	4	4	4	4	4
Preset 3	4	4	4	4	4	4	12	
Preset 4	12		4	4	4	4	4	4
Preset 5	4	4	12		4	4	4	4
Preset 6	3	10	4	4	12		12	
Preset 7	10	10	11	4	4	4	4	4
Preset 8	1	1	2	2	3	3	4	4
Preset 9	4	4	0	0	0	0	0	0
Preset 10	0	0	0	0	0	0	4	4
Preset 11	4	0	0	0	0	0	0	0

Preset 12	0	0	0	0	0	0	0	4
Preset 13	3	3	11	4	4	0	0	0
Preset 14	4	3	10	4	4	4	12	
Preset 15	4	4	4	11	11	0	12	
Preset 16	3	10	10	11	0	0	12	

Custom Fleet Maps

To program a custom fleet map, select *Custom* under the *Edit Fleet Map* option. Then, select the appropriate size code for each block. Remember, not all size codes are available for all blocks:

Block	Valid Size Codes
Block 0	0 - 14
Block 1	0 - 13 (14 not valid)
Block 2	0 - 13 (14 not valid)
Block 3	0 - 13 (14 not valid)
Block 4	0 - 13 (14 not valid)
Block 5	0 - 12 (13, 14 not valid)
Block 6	0 - 12 (13, 14 not valid)

Block 7	0 - 11 (12, 13, 14 not valid)
------------	----------------------------------

How Fleet Maps Work

Blocks

Talk Group IDs can range from 0 to 65,535. To make it easier to handle this many IDs, the system divides the TGID range into 8 equal *blocks* :

Block	Starting ID	Ending ID
Block 0	0	8191
Block 1	8192	16383
Block 2	16384	24575
Block 3	24576	32767
Block 4	32768	40959
Block 5	40960	49151
Block 6	49152	57343
Block 7	57344	65535

Size Codes

Each block is assigned a *size code* based on the way the control channel sends the TGID data. Note that codes 12, 13, and 14 take up more than one block:

Size Code	Fleet / SubFleet? / ID	Number of Blocks Needed
0	(as Type II ID)	1
1	128 / 4 / 16	1
2	16 / 8 / 64	1
3	8 / 8 / 128	1
4	1 / 16 / 512	1
5	64 / 4 / 32	1
6	32 / 8 / 32	1
7	32 / 4 / 64	1
8	16 / 4 / 128	1
9	8 / 4 / 256	1
10	4 / 8 / 256	1
11	2 / 16 / 256	1
12	1 / 16 / 1024	2
13	1 / 16 / 2048	4
14	1 / 16 / 4096	8

This page applies to the following scanner(s): [BCD996XT](#) [BCT15X](#) [BCD396XT](#) [BC346XT](#) [Users Guide](#)

Priority Scan

To determine whether the information on this page applies to your scanner, see the tags at the bottom of the page.

This section applies to conventional system priority mode only. For priority on trunked systems, turn on the Priority ID system option and set the desired channels as priority channels.

Priority mode has two "sub modes" (similar to Close Call and Close Call Only):

- In *Priority Scan* mode, the scanner pauses the current operation at a designated interval to check for activity on any unlocked channels set as priority channels. After the priority channel check is complete, the scanner resumes the previous operation.
- In *Priority Plus Scan* mode, the scanner stops the current operation and only checks the priority channels.
- [Priority Scan menu](#)
 - [Set Priority](#)
 - [Set Interval](#)
 - [MaxCHs/Pri-Scan](#)

Priority Scan menu

Use the *Priority Scan* menu to control how Priority mode operates:

Set Priority

Choose one of the following priority scan methods:

- *On* : Enter Priority Scan mode; also, the scanner performs a normal priority scan whenever you enter Priority mode in the future.
- *Plus On* : Enter Priority Plus Scan mode; also, the scanner performs a priority plus scan whenever you enter Priority mode in the future.
- *Off* : Exit Priority mode, and do not go into Priority mode in the future.

Set Interval

Decide how many seconds you want the scanner to wait between priority channel checks. Enter a number between 1 and 10 seconds. (This setting is used in normal priority scans only.)

MaxCHs/Pri-Scan

Decide how many priority channels the scanner checks during each interval. Enter a number between 1 and 100. If the number of priority channels is greater than the number you enter here, the scanner divides them into groups. For example, if you set the maximum channels to 20 and there are 100 priority channels, the scanner checks those 100 channels in groups of 20 and takes a total of 5 intervals to complete the priority scan.

This page applies to the following scanner(s): [BCD996XT](#) [BCT15X](#) [BCD396XT](#)
[BC346XT Users Guide](#)

Program Location

The *Program Location* menu lets you create and edit points of interest (*POI*), intersections(*Dangerous Xing*), and roads (*Dangerous Road*). The available settings vary for each location type.

- [POI](#)
 - [Edit Name](#)
 - [Set Type](#)
 - [Set Alert](#)
 - [Set Alert Light](#)
 - [Set Alert Tone](#)
 - [Set Location Info](#)
 - [Set Range](#)
 - [Set Lockout](#)
 - [Delete Location](#)
 - [New Location](#)
- [Dangerous Xing and Dangerous Road menus](#)
 - [Edit Name](#)
 - [Set Type](#)
 - [Set Alert Volume](#)
 - [Set Alert Light](#)
 - [Set Location Info](#)
 - [Set Heading](#)
 - [Set Speed Limit](#)
 - [Set Lockout](#)
 - [Delete Location](#)
 - [New Location](#)

POI

Edit Name

Enter a name or edit the existing one. Names can be 16 characters long, and they can contain upper and lower case letters, punctuation, and spaces. Turn the **SELECT-**

VOLUME-SQUELCH knob on the handheld scanners or the **SCROLL / FUNCTION** knob on mobile scanners to choose the character you want, then press **6** (right cursor) to move the cursor to the next character.

Set Type

When you create a location, the location is created as the type you are currently viewing (POI, Dangerous Xing, or Dangerous Road). If you want to change the location type, you can select the new location type here.

When you change the location type, the scanner goes back to the *Program Location* menu. Select the new location type to edit this location; the scanner resets the available options based on the new location type.

Set Alert

This menu lets you configure whether the scanner triggers an alert tone and light when you approach this location.

[Set Alert Light](#)

This setting is exactly the same as its counterpart on the system, site, and channel menus. Click on the setting for a complete explanation.

Set Alert Tone

Choose one of the available alert tones for this POI:

- *Alert 1 :*

1047 Hz for 125 ms / Silence for 50 ms / 1047 Hz for 125 ms / Silence for 50 ms / 1319 Hz for 125 ms / Silence for 50 ms / 1568 Hz for 125 ms / Silence for 175 ms / 1319 Hz for 125 ms / Silence for 50 ms / 1568 Hz for 125 ms

- *Alert 2 :*

1047 Hz for 200 ms / Silence for 200 ms / 1760 Hz for 250 ms / Silence

for 100 ms / 1397 Hz for 250 ms

- *Alert 3 :*

2093 Hz for 125 ms / Silence for 50 ms / 1976 Hz for 125 ms / Silence for 50 ms / 2093 Hz for 125 ms

- *Alert 4 :*

1319 Hz for 25 ms / Silence for 50 ms / 1397 Hz for 25 ms / Silence for 50 ms / 1175 Hz for 25 ms / Silence for 50 ms / 1319 Hz for 25 ms

- *Off* (No alert tone sounded).

If you select an alert tone, the scanner prompts you to select the volume level (*Level 1* through *Level 15*) you want to the alert tone to use; leave the volume at *Auto* to have the scanner sound the alert tone without changing the volume.

Set Location Info

Enter the latitude and longitude for this location.

Set Range

Enter how far out from this location you want the scanner to alert you. You can configure the scanner to sound an alert tone and flash a light when you reach the radius entered here. The scanner treats the number you enter here as miles or kilometers depending on the value you selected in the *Set Unit* field in the *Set GPS Format* menu (under the main [Settings](#) menu). Enter a range from 0.05 through 4.0 mi/km, in 0.05 mi/km steps.

Set Lockout

Decide whether you want to lock out this location so the scanner no longer checks it.

Choose *Unlocked* (default), *Temporary L/O* (the location is locked out until you turn the scanner off and back on), or *Lockout* (the location is locked out until you change this setting).

Delete Location

Delete this location and its settings, including any alert settings.

New Location

Create a new location.

Dangerous Xing and Dangerous Road menus

(The settings and available options for dangerous crossings and dangerous roads are exactly the same.)

Edit Name

Enter a name or edit the existing one. Names can be 16 characters long, and they can contain upper and lower case letters, punctuation, and spaces. Turn the **SELECT-VOLUME-SQUELCH** knob on the handheld scanners or the **SCROLL / FUNCTION** knob on mobile scanners to choose the character you want, then press **6** (right cursor) to move the cursor to the next character.

Set Type

When you create a location, the location is created as the type you are currently viewing (POI, Dangerous Xing, or Dangerous Road). If you want to change the location type, you can select the new location type here. When you change the location type, the scanner goes back to the *Program Location menu* . Select the new location type to edit this location; the scanner resets the available options based on the new location type.

Set Alert Volume

Activate the alert tone for this location. Select the volume level (*Level 1* through *Level 15*) you want to the alert tone to use, or select *Auto* to have the scanner sound the alert tone without changing the volume. If you don't want the scanner to sound an alert as you approach this location, select *Off* .

The tone pattern varies depending on what type of location this is:

- Dangerous Xing alert tone:

1175 Hz for 250 ms / Silence for 50 ms / 1319 Hz for 50 ms / Silence for 50 ms / 1397 Hz for 250 ms

- Dangerous Road alert tone

1568 Hz for 250 ms / Silence for 50 ms / 1760 Hz for 50 ms / Silence for 50 ms / 1976 Hz for 250 ms / Silence for 50 ms / 2093 Hz for 50 ms / Silence for 50 ms / 1047 Hz for 250 ms

[Set Alert Light](#)

This setting is exactly the same as its counterpart on the system, site, and channel menus. Click on the setting for a complete explanation.

Set Location Info

Enter the latitude and longitude for this location.

Set Heading

Decide whether the scanner alerts you of this Dangerous Xing or Road each time you approach it or only when you are traveling in a particular direction. To make the alert direction-dependent, select the direction from the list; select *All Range* to be alerted regardless of your direction.

Set Speed Limit

Decide whether the scanner alerts you of this Dangerous Xing or Road each time you approach it or only when you are traveling above a certain speed. To make the alert speed-dependent, enter the speed limit for this location; leave the speed limit blank to be alerted regardless of your speed. The scanner treats the number you enter here as miles or kilometers depending on the value you selected in the Set Unit field in the Set GPS Format menu (under the main Settings menu). Enter a range from 0 through 200 mi/km, in 1 mi/km steps.

Set Lockout

Decide whether you want to lock out this location so the scanner no longer checks it.

Choose *Unlocked* (default), *Temporary L/O* (the location is locked out until you turn the scanner off and back on), or *Lockout* (the location is locked out until you change this setting).

Delete Location

Delete this location and its settings, including any alert settings.

New Location

Create a new location.

This page applies to the following scanner(s): [BCD996XT](#) [BCT15X](#) [BCD396XT](#)
[BC346XT Users Guide](#)

Search and Store

To determine whether the information on this page applies to your scanner, see the tags at the bottom of the page.

With this feature, the scanner searches a system and saves any frequencies it finds activity on. When the scanner detects activity on a frequency, it verifies that the frequency has not already been stored, then adds the frequency to the *Found Channels* group. (Since these frequencies are stored with individual systems, you must have at least one programmed system to use the Search and Store feature.)

The scanner displays a list of all programmed systems. Select the system you want to search and add found channels to. The options you have depend on the type of system you select:

- If the system you selected is a **conventional system** , the scanner prompts you to select a custom search or a preset service search range.
- If the system you selected is a **trunked system** , the scanner prompts you to select a site within that system. The scanner searches the site for active Talk Groups and stores the Talk Group ID to the *Found Channels* group. (If the site you selected is locked, the scanner automatically unlocks it and begins the search.)
- If the system you selected is an **EDACS SCAT system** , the scanner displays an error message: the search and store feature can't be used on EDACS SCAT systems.

[Back to Search menu](#)

This page applies to the following scanner(s): [BCD996XT](#) [BCT15X](#) [BCD396XT](#)
[BC346XT](#) [Users Guide](#)

Search for...

To determine whether the information on this page applies to your scanner, see the tags at the bottom of the page.

Use this menu to start a search, to change the options for the three different types of searches, and program the 3 search keys.

- [Service Search](#)
- [Edit Service](#)
 - [Set Delay Time](#)
 - [Set Attenuator](#)
 - [Set Audio AGC \(BCD996XT and BCD396XT Only\)](#)
 - [Set Record \(BCD996XT and BCT15X Only\)](#)
 - [P25 Waiting Time \(BCD996XT and BCD396XT Only\)](#)
 - [Search with Scan](#)
- [Custom Search](#)
- [Edit Custom](#)
 - [Edit Name](#)
 - [Edit Srch Limit](#)
 - [Set Delay Time](#)
 - [Set Modulation](#)
 - [Set Attenuator](#)
 - [Set Step](#)
 - [Set C-Ch Only](#)
 - [Set MOT Band Plan](#)
 - [Set Audio AGC \(BCD996XT and BCD396XT Only\)](#)
 - [Set Record \(BCD996XT and BCT15X Only\)](#)
 - [P25 Waiting Time \(BCD996XT and BCD396XT Only\)](#)
 - [Search with Scan](#)
- [Search and Store](#)
- [Set Search Key](#)

Service Search

Start a search of one of the 12 preset service bands. Choose from *Public Safety, News, HAM Radio, Marine, Railroad, Air, CB Radio, FRS/GMRS/MURS, Racing, FM Broadcast, Military Air* , or *Special* .

Edit Service

This menu lets you change the default settings for the 12 preset service bands. Select the service you want to edit from the list, then set the following options:

Set Delay Time

Set the number of seconds the scanner should wait after a transmission stops before moving on to the next channel. Select *0, 1, 2* (default), *5, 10*, or *30 seconds*.

To have scanner leave the channel after a designated number of seconds whether the transmission stops or not, select one of the negative values. Choose *-10* seconds to have the scanner leave the channel after 10 seconds even if the transmission is still going on; choose *-5 seconds* or *-2 seconds* to have the scanner leave after 5 seconds or 2 seconds, respectively.

Set Attenuator

Turn on attenuation to reduce the signal strength by 20 dB. All frequencies in the search range are attenuated during search.

Set Audio AGC (BCD996XT and BCD396XT Only)

Turn on Automatic Gain Control (AGC) for this system. When you activate this feature, the scanner automatically adjusts the volume for each channel based on the signal strength. You can turn on the gain control for *Analog* and *Digital* signals separately.

To change the settings for the audio AGC, see [Adjust Audio AGC](#)

Set Record (BCD996XT and BCT15X Only)

Set the scanner to provide the audio from found transmissions to the RECORD OUT jack on the back of the scanner.

P25 Waiting Time (BCD996XT and BCD396XT Only)

When searching in a band that has a mix of analog and digital signals (i.e., where the *Audio Mode* is set to *All*), it is possible to have *false decode* problems that results in digital noise at the beginning of transmissions. To prevent this, a user-configurable P25 wait time (from 0 to 1000 ms) has been added.

During the wait time, the scanner evaluates the received signal; if it detects P25 data, the scanner opens squelch immediately. If it does not detect any P25 data, the scanner opens squelch as soon as the wait time expires.

Note: Any analog transmissions on this channel will lose the first part of the transmission, up to the wait time you set here.

Select the number of milliseconds (after the start of a transmission) the scanner should wait while checking for P25 data. Choose a number from 0 through 1000 ms in 100 ms increments. The scanner only applies the wait time when *Tone/Code Search* in *Srch/CloCall Opt* is set to *Off*.

[Search with Scan](#)

Custom Search

Start a search of the 10 custom search ranges.

Edit Custom

This menu lets you program the ten custom search ranges. Select the custom search you want to edit from the list, then set the following options:

Edit Name

Enter a name or edit the existing one. Names can be 16 characters long, and they can contain upper and lower case letters, punctuation, and spaces. Turn the **SELECT-VOLUME-SQUELCH** knob on the handheld scanners or the **SCROLL / FUNCTION** knob on mobile scanners to choose the character you want, then press **6** (right cursor) to

move the cursor to the next character.

Edit Srch Limit

Change the range of frequencies covered by this custom search. The scanner prompts you to input the lower frequency limit and then the upper frequency limit.

Set Delay Time

Set the number of seconds the scanner should wait after a transmission stops before moving on to the next channel. Select *0*, *1*, *2* (default), *5*, *10*, or *30 seconds*.

To have scanner leave the channel after a designated number of seconds whether the transmission stops or not, select one of the negative values. Choose *-10* seconds to have the scanner leave the channel after 10 seconds even if the transmission is still going on; choose *-5 seconds* or *-2 seconds* to have the scanner leave after 5 seconds or 2 seconds, respectively.

Set Modulation

Select what type of modulation the scanner should use for this frequency or channel. (Only the modulation types available for this frequency or channel are displayed.)

Auto	The scanner uses the default modulation type for this frequency's band.
AM	The scanner treats the frequency as an AM band.
NFM	The scanner treats the frequency as a Narrowband FM band.
FM	The scanner treats the frequency as an FM band.
WFM	The scanner treats the frequency as a Wideband FM band.
FMB	The scanner treats the frequency as an FM broadcast band.

Set Attenuator

Turn on attenuation to reduce the signal strength by 20 dB. All frequencies in the search range are attenuated during search.

Set Step

Select the number of kHz between each channel. Choose *5.0, 6.25, 7.5, 8.33, 10.0, 12.5, 15.0, 20.0, 25.0, 50.0* or *100.0 kHz*. Select *Auto* to use the default step for this band.

Set C-Ch Only

If you activate this feature, you can monitor this system by programming only the control channel (instead of programming the control channel and all the voice channels).

When you use C-Ch Only, you will not be able to use the Trunking Channel Activity Indicators, but you will save memory.

Set MOT Band Plan

If this custom search is a Motorola system, you need to select a band plan, just like you do when you program a Motorola system for scanning. See [Edit Band Plan](#) for more information.

Set Audio AGC (BCD996XT and BCD396XT Only)

Turn on Automatic Gain Control (AGC) for this system. When you activate this feature, the scanner automatically adjusts the volume for each channel based on the signal strength. You can turn on the gain control for *Analog* and *Digital* signals separately.

To change the settings for the audio AGC, see [Adjust Audio AGC](#)

Set Record (BCD996XT and BCT15X Only)

Set the scanner to provide the audio from found transmissions to the RECORD OUT jack on the back of the scanner.

P25 Waiting Time (BCD996XT and BCD396XT Only)

When searching in a band that has a mix of analog and digital signals (i.e., where the *Audio Mode* is set to *All*), it is possible to have *false decode* problems that results in digital noise at the beginning of transmissions. To prevent this, a user-configurable P25 wait time (from 0 to 1000 ms) has been added.

During the wait time, the scanner evaluates the received signal; if it detects P25 data, the scanner opens squelch immediately. If it does not detect any P25 data, the scanner opens squelch as soon as the wait time expires.

Note: Any analog transmissions on this channel will lose the first part of the transmission, up to the wait time you set here.

Select the number of milliseconds (after the start of a transmission) the scanner should wait while checking for P25 data. Choose a number from 0 through 1000 ms in 100 ms increments. The scanner only applies the wait time when *Tone/Code Search* in *Srch/CloCall Opt* is set to *Off*.

[Search with Scan](#)

[Search and Store](#)

Search a stored system and save the frequency information of any active channels.

Set Search Key

The scanner has three one-touch search keys (number keys **1** , **2** , and **3**) that you can assign to any saved search range.

1. Select the search key you want to program (*Search Key 1* through *Search Key 3*).
2. Select the search range you want to assign to this key. The search range can be a service search, a custom search, a tone-out search, or a band scope search.
3. Press **YES** to confirm the selection.

Once you assign a search range to a key, you can start the search just by pressing the appropriate key.

This page applies to the following scanner(s): [BCD996XT](#) [BCD396XT](#) [Users Guide](#)

Search with Scan

To determine whether the information on this page applies to your scanner, see the tags at the bottom of the page.

- [Set Quick Key](#)
- [Set Startup Key](#)
- [Set Number Tag](#)
- [Set Lockout](#)
- [Set Hold Time](#)

Set Quick Key

Assign this search range to a Quick Key so you can easily enable or disable it during scanning. Enter a number from 0 to 99; tap NO (the decimal point) if you don't want to assign this search range to a Quick Key. (For more information, see [Quick Keys](#).)

Set Startup Key

Assign this search range to a Startup Key so you can lock or unlock it during power up. Enter a number from 0 to 9; tap NO (the decimal point) if you don't want to assign this search range to a Startup Key. (For more information, see [Startup Keys](#).)

Set Number Tag

Assign a number to this search range that you can use to quickly access the first frequency of the the search range. Choose a number from 0 to 999. (For more information, see [Number Tags](#).)

Set Lockout

Decide whether you want to lock out the search so the scanner will ignore it during Scan and Search modes. Choose one of the following options:

- *Unlocked*: The search range is included while scanning.
- *Temporary L/O*: The search range is locked out until you turn the scanner off and

back on.

- *Lockout*: The search range is permanently locked out.

Set Hold Time

Set how long the scanner spends checking this search range before moving to the next search range or system. (2 seconds is the default).

This page applies to the following scanner(s): [BCD996XT](#) [BCT15X](#) [BCD396XT](#)
[BC346XT Users Guide](#)

Set Alert Tone

Choose one of the 9 different tone patterns for the scanner to use for the alert tone:

Alert 1	4000 Hz for 50 ms » Silence for 20 ms » 4000 Hz for 50 ms » Silence for 20 ms » 4000 Hz for 50 ms
Alert 2	800 Hz for 50 ms » Silence for 20 ms » 1050 Hz for 50 ms » Silence for 20 ms » (repeat twice)
Alert 3	800 Hz for 50 ms » Silence for 20 ms » 1050 Hz for 50 ms » Silence for 20 ms » 4000 Hz for 100 ms
Alert 4	120 Hz for 10 ms » 800 Hz for 10 ms » 1200 Hz for 10 ms (repeat 5 times)
Alert 5	1200 Hz for 150 ms
Alert 6	1200 Hz for 70 ms » Silence for 50 ms » 1200 Hz for 70 ms
Alert 7	2000 Hz for 200 ms » Silence for 10 ms » 800 Hz for 150 ms (repeat 3 times)
Alert 8	500 Hz for 40 ms » Silence for 10 ms » 500 Hz for 40 ms » Silence for 10 ms » 500 Hz for 40 ms
Alert 9	2400 Hz for 70 ms » Silence for 20 ms » 3000 Hz for 70 ms » Silence for 70 ms (repeat twice)
Off	No alert tone sounded.

If you select an alert tone, the scanner prompts you to select the volume level (*Level 1* through *Level 15*) you want the alert tone to use; leave the volume at *Auto* to have the scanner sound the alert tone without changing the volume.

This page applies to the following scanner(s): [BCD996XT](#) [BCT15X](#) [BCD396XT](#) [BC346XT](#) [Users Guide](#)

Srch/CloCall Opt

To determine whether the information on this page applies to your scanner, see the tags at the bottom of the page.

This menu lets you set general options for how the scanner operates in Search and Close Call modes.

- [Freq Lockouts](#)
- [Broadcast Screen](#)
 - [Set All Band On](#)
 - [Set All Band Off](#)
 - [Set Each Band](#)
 - [Program Band](#)
- [Tone/Code Search](#)
- [Repeater Find](#)
- [Max Auto Store](#)
- [Set Delay Time](#)
- [Set Attenuator](#)
- [Set Audio AGC](#)
- [Set Record \(BCD996XT and BCT15X only\)](#)
- [P25 Waiting Time](#)

Freq Lockouts

- *Rvw Search L/O* : This option displays a list of all locked out frequencies. To unlock any frequency on the list, just select it and press **YES** .
- *Unlock All* : This option removes the locks on all frequencies at once.

Broadcast Screen

Choose whether you want the scanner to screen out common broadcast bands and ignore hits on these bands. You can screen out signals on 5 preset bands and up to 10 custom bands. The preset bands are:

- *Pager*
- *FM* (88.1000 - 107.9000 MHz)
- *UHF TV* (470.0000 - 512.0000 MHz)
- *VHF TV* (54.0000 - 72.0000, 76.0000 - 88.0000, and 174.0000 - 216.0000 MHz)
- *NOAA WX* (161.6500, 161.7750, 162.4000, 162.4250, 162.4500, 162.4750, 162.5000, 162.5250, 162.5500, and 163.2750 MHz)

Your options for broadcast screening are listed below:

Set All Band On

Turn on screening for all broadcast bands and ignore any hits on these frequencies.

Set All Band Off

Turn off screening for all broadcast bands, and treat hits on these frequencies the same as any other band.

Set Each Band

Turn screening on or off for each band individually. The scanner displays the bands listed above. Select the band you want to change, then press **YES** to toggle the setting.

Program Band

Create up to 10 custom bands that you want the scanner to screen out hits on.

1. Select a custom band slot (Band 1 through Band 10).
2. When the scanner prompts you, input the lower frequency limit.
3. When the scanner prompts you, input the upper frequency limit.
4. Once you create the custom band, turn screening on or off the same way you did for the preset bands.

Tone/Code Search

Choose whether the scanner searches an active frequency for CTCSS/DSC tones (*CTCSS/DSC Search*), P25 NAC codes (*P25 NAC Search*), or neither (*Off*). (The

scanner ignores this setting in AM, WFM, and FMB bands.)

Repeater Find

If you turn this feature on, whenever the scanner detects a signal on a common repeater input frequency, it automatically searches for that signal on the output frequency. If it finds the signal on the output frequency, the scanner displays *Repeater Found* and switches to monitor the output frequency.

Max Auto Store

Enter the maximum number of hits you want the scanner to store during Search and Store mode or Close Call Auto Store mode. When the number of stored hits reaches the number you enter here, the scanner stops storing hits. Enter a number from *1* to *256* .

Set Delay Time

Set the number of seconds the scanner should wait after a transmission stops before moving on to the next channel. Select *0*, *1*, *2* (default), *5*, *10*, or *30 seconds*.

To have scanner leave the channel after a designated number of seconds whether the transmission stops or not, select one of the negative values. Choose *-10* seconds to have the scanner leave the channel after 10 seconds even if the transmission is still going on; choose *-5 seconds* or *-2 seconds* to have the scanner leave after 5 seconds or 2 seconds, respectively.

Set Attenuator

Turn on attenuation to reduce the signal strength by 20 dB. When you turn on this setting, all frequencies in Quick Search mode, Close Call mode, and the Band Scope will be attenuated.

Set Audio AGC

Turn on Automatic Gain Control (AGC) for this system. When you activate this feature, the scanner automatically adjusts the volume for each channel based on the signal strength. You can turn on the gain control for *Analog* and *Digital* signals separately.

To change the settings for the audio AGC, see [Adjust Audio AGC](#)

Set Record (BCD996XT and BCT15X only)

Set this to *On* to have the audio from active frequencies included on the scanners rear RECORD OUT jack.

P25 Waiting Time

During search and Close Call operation, it is possible to have *false decode* problems that result in digital noise at the beginning of transmissions. To prevent this, a user-configurable P25 wait time (from 0 to 1000 ms) has been added.

During the wait time, the scanner evaluates the received signal; if it detects P25 data, the scanner opens squelch immediately. If it does not detect any P25 data, the scanner opens squelch as soon as the wait time expires.

Note: Any analog transmissions will lose the first part of the transmission, up to the wait time you set here.

Select the number of milliseconds (after the start of a transmission) the scanner should wait while checking for P25 data. Choose a number from 0 through 1000 ms in 100 ms increments. This setting will be applied in Close Call, Quick Search, and Band Scope modes.

This page applies to the following scanner(s): [BCD996XT](#) [BCD396XT](#) [Users Guide](#)

Startup Keys

Startup Keys let you change the lockout state for several systems, sites, and search ranges all at the same time. When you activate the Startup Key, the scanner checks all systems, sites, or search ranges and locks or unlocks them according to these rules:

- If any systems, sites, or search ranges *do not have* a Startup Key assigned, the scanner does not change their locked/unlocked state (i.e., if they are unlocked, it leaves them unlocked).
- If any systems, sites, or search ranges *do have* an assigned Startup Key, the scanner compared the assigned Startup Key to the one you activated:
 - If a system's Startup Key *does not match* the one you activated, the scanner *locks* that system.
 - If a system's Startup Key *matches* the one you activated, the scanner *unlocks* that system and enables all of its Quick Keys.

Assigning Startup Keys

- Multiple systems, sites, and search ranges can share the same Startup Key.
- Startup Keys range from 0 to 9 .
- If you do not want a system, site, or search range to be affected by any Startup Keys, enter the decimal point for the Startup Key (this is the default setting).

To a conventional system:

1. Open the [Program System](#) menu.
2. Select the system you want to assign the Startup Key to.
3. Select [Edit Sys Option](#), then select [Set Startup Key](#).
4. Enter the Startup Key you want to use for this system.

To a trunked system:

1. Open the [Program System](#) menu.
2. Select the system you want to assign the Startup Key to.
3. Select [Edit Site](#), then select the site you want.
4. Select [Set Startup Key](#), then enter the Startup Key you want to use for this site.

To a service search range :

1. Open the [Search for...](#) menu.
2. Select [Edit Service](#), then select the service search range you want to assign the Startup Key to.
3. Select [Search with Scan](#), then select [Set Startup Key](#).
4. Enter the Startup Key you want to use for this search range.

To a custom search range :

1. Open the [Search for...](#) menu.
2. Select [Edit Custom](#), then select the custom search range you want to assign the Startup Key to.
3. Select [Search with Scan](#), then select [Set Startup Key](#).
4. Enter the Startup Key you want to use for this custom search range.

Using Startup Keys

To activate a Startup Key:

1. Turn the scanner off.
2. Press & hold the number key that corresponds to the Startup Key while you power the scanner on. (e.g. To activate Startup Key configuration # 2, press & hold **2** on the number pad while turning the scanner on.)
3. Continue holding the number key until the scanner display shows the number of the Startup Key configuration (In the example above, the display shows *Startup Config. Key No. 2*).

For example, say you have 4 systems programmed according to the table below:

Assigned Startup Key	State
3	Locked
None (.)	Unlocked
None (.)	Locked

9	Unlocked
---	----------

Here is the result if you power on the scanner while you press and hold **3** :

Assigned Startup Key	Previous state	Resulting state
3	Locked	Unlocked
None (.)	Unlocked	Unlocked (no change)
None (.)	Locked	Locked (no change)
9	Unlocked	Locked

Here is the result if you power on the scanner while you press and hold **5** :

Assigned Startup Key	Previous state	Resulting state
3	Locked	Locked
None (.)	Unlocked	Unlocked (no change)
None (.)	Locked	Locked (no change)
9	Unlocked	Locked

This page applies to the following scanner(s): [BCD996XT](#) [BCT15X](#) [BCD396XT](#) [BC346XT](#) [Users Guide](#)

Tone A and Tone B Settings

You can configure the scanner to search for tones in several different ways, based on the values you enter for Tone A and Tone B:

	Tone A setting	Positive number	Tone B Setting	Positive number
Operation	Monitor the channel for two-tone pages only. The scanner opens squelch and displays the tone information when the following occur: <ol style="list-style-type: none"> 1. The scanner detects a tone that matches the value you set for Tone A. 2. The tone is at least 250 ms long. 3. Within 500 ms, the scanner detects a second tone that matches the value set for Tone B. 4. The second tone is at least 100 ms long. 			
	Tone A setting	Positive number	Tone B Setting	0.0 Hz
Operation	Monitor the channel for single-tone pages only. The scanner opens squelch and displays the tone information when the following occur: <ol style="list-style-type: none"> 1. The scanner detects a tone that matches the value you set for Tone A. 2. The tone is at least 1.25 seconds long and not more than 3.75 seconds long. 			
	Tone A setting	0.0 Hz	Tone B Setting	Positive number

Operation	<p>Monitor the channel for group tones only. The scanner opens squelch and displays the tone information when the following occur:</p> <ol style="list-style-type: none"> 1. The scanner detects a tone that matches the value you set for Tone B. 2. The tone is at least 3.75 seconds long. 			
	Tone A setting	0.0 Hz	Tone B Setting	0.0 Hz
Operation	<p>Monitor the channel for two-tone pages, single-tone pages, and group tones. This tone out search mode works as follows:</p> <ol style="list-style-type: none"> 1. All detected tones are compared to the three criteria listed above. 2. If the tone meets any one of the criteria, the scanner checks to see if this tone frequency is already saved to a tone out channel with the same frequency, modulation, and attenuator settings. 3. If the detected tone matches a saved tone, the scanner opens squelch. 4. If the detected tone does not match any saved tones, the scanner opens squelch, flashes the tone information on the display, and asks if you want to save the tone information. 			

This page applies to the following scanner(s): [BCD996XT](#) [BCT15X](#) [BCD396XT](#) [BC346XT](#) [Users Guide](#)

Tone-Out for...

To determine whether the information on this page applies to your scanner, see the tags at the bottom of the page.

- [Tone-Out Standby](#)
- [Tone-Out Setup](#)
 - [Edit Name](#)
 - [Set Frequencies](#)
 - [Set Tone](#)
 - [Set Delay Time](#)
 - [Set Alert](#)
 - [Set Alert Tone](#)
 - [Set Alert Light](#)
 - [Set Audio AGC \(BCD396XT and BCD996XT Only\)](#)
 - [Set Record \(BCD996XT and BCT15X Only\)](#)
- [Tone-Out Search](#)

Tone-Out Standby

Check the tone out channels for paging tones, according to each channel's individual settings.

Tone-Out Setup

This menu lets you configure the 10 tone-out channels. Select the channel you want to edit from the list, then set the frequency, tone, and other options for that channel.

Edit Name

Enter a name or edit the existing one. Names can be 16 characters long, and they can contain upper and lower case letters, punctuation, and spaces. Turn the **SELECT-VOLUME-SQUELCH** knob on the handheld scanners or the **SCROLL / FUNCTION** knob on mobile scanners to choose the character you want, then press **6** (right cursor) to move the cursor to the next character.

[Set Frequencies](#)

Use this menu to program frequencies for this Tone Out channel.

Set Tone

This menu lets you configure the type of tone out search. Select the tone you want to edit (*Edit Tone A* or *Edit Tone B*), then set the frequency for that tone. Enter a frequency between 250 Hz and 3500 Hz, or set the frequency to 0 Hz. (See [Tone A and Tone B Settings](#) for more information.)

Set Delay Time

Set the number of seconds the scanner should wait after a transmission stops before moving on to the next channel. Select *0*, *1*, *2* (default), *5*, *10*, or *30 seconds* . To have the scanner wait for your input before moving on to the next channel, select *Infinite* .

Set Alert

Decide whether the scanner triggers an alert tone and light when it detects a tone on this channel. (Compare this to the system setting [Emergency Alert](#), which triggers a tone and light when a Talk Group contains an emergency flag.) The available options for [Set Alert Tone](#) and [Set Alert Light](#) are common to both types of alerts.

[Set Alert Tone](#)

[Set Alert Light](#)

Set Audio AGC (BCD396XT and BCD996XT Only)

Turn on Automatic Gain Control (AGC) for this Tone-Out channel. When you activate this feature, the scanner automatically adjusts the volume for the channel based on the signal strength.

To change the settings for the audio AGC, see [Settings#Adjust Audio AGC](#).

Set Record (BCD996XT and BCT15X Only)

Turn this setting on to have the audio from received tone-outs included on the rear RECORD OUT jack.

Tone-Out Search

You can set the scanner to search for and identify the tones used in tone-outs. To do so, you set both the A and B tones to a value of "0". See [Tone A and Tone B Settings](#) for more information.

This page applies to the following scanner(s): [BCD996XT](#) [BCT15X](#) [BCD396XT](#)
[BC346XTUsers Guide](#)

WX Operation

To determine whether the information on this page applies to your scanner, see the tags at the bottom of the page.

This menu lets you configure how the scanner operates in Weather (WX) mode and Weather Alert (WX Alert) mode.

- [Weather Scan](#)
- [Weather Alert](#)
 - [Alert Only](#)
 - [SAME 1 through SAME 5](#)
 - [All FIPS](#)
- [Program SAME](#)
 - [Edit Name \(SAME\)](#)
 - [Edit County](#)
- [Set Delay Time](#)
- [Set Attenuator](#)
- [Set Audio AGC](#)
- [Set Record \(BCD996XT and BCT15 Only\)](#)
- [WX Alt Priority](#)

Weather Scan

Start a normal weather scan. In normal weather scan mode, the scanner does not react to alert tones on weather channels.

Weather Alert

Choose how you want the scanner to filter any alerts it detects on the weather channels:

Alert Only

The scanner responds to all alert tones detected on the weather channels, regardless of region or hazard level. When an alert is detected, the scanner sounds an alert siren and

opens squelch on the weather channel.

SAME 1 through SAME 5

Choose one of 5 programmable regions to filter alerts by. The scanner only responds to alerts that affect the selected region you select here, and only if the hazard level is an Advisory, a Watch, or a Warning. When an alert is detected, the scanner sounds an alert siren, displays available information (hazard level, type, etc.) on the screen, and opens squelch on the weather channel.

All FIPS

The scanner responds to alerts regardless of region, but only if the hazard level is an Advisory, a Watch, or a Warning. When an alert is detected, the scanner sounds an alert siren, displays available information (hazard level, type, etc.) on the screen, and opens squelch on the weather channel.

Program SAME

You can pre-program up to 5 regions for filtering hazard alerts, then select one of these regions on the Weather Alert menu. The scanner will only respond to alerts in the selected region.

Edit Name (SAME)

Enter the name you want to use for each region. The default names are SAME 1 through SAME 5.

Edit County

Enter the designated FIPS code for up to 8 counties. To edit a FIPS code, select it from the list. Use the number keypad to enter the 6-digit code, and press YES when you're finished. If you don't enter all 6 digits, the scanner can't store the code and displays it as "-----" on the county list.

(See [Introduction to SAME messages](#) for more information.)

Set Delay Time

Set the number of seconds the scanner should wait after a transmission stops before moving on to the next channel. Select *0*, *1*, *2* (default), *5*, *10*, or *30 seconds*.

To have scanner leave the channel after a designated number of seconds whether the transmission stops or not, select one of the negative values. Choose *-10* seconds to have the scanner leave the channel after 10 seconds even if the transmission is still going on; choose *-5 seconds* or *-2 seconds* to have the scanner leave after 5 seconds or 2 seconds, respectively.

Note that since weather broadcasts are continuous, the scanner does not apply negative delays. If you select a negative delay in this mode, the scanner will treat it as a 2 second delay.

Set Attenuator

Turn on attenuation to reduce the signal strength by 20 dB. You can turn on attenuation for individual frequencies and channels or for entire sites. If you turn on attenuation for a site, all frequencies within that site will be attenuated.

Set Audio AGC

Turn on Automatic Gain Control (AGC) for this system. When you activate this feature, the scanner automatically adjusts the volume for each channel based on the signal strength. You can turn on the gain control for *Analog* and *Digital* signals separately.

To change the settings for the audio AGC, see [Adjust Audio AGC](#)

Set Record (BCD996XT and BCT15 Only)

Turn on this option if you want the weather mode audio to be included on the rear RECORD OUT jack.

WX Alt Priority

Select *On* if you want the scanner to check the weather channels in the background

during Scan, Search, or Close Call mode. The scanner can't run Weather Alert Priority check in Search and Store, Close Call Auto Store, Tone-Out or Band Scope modes.

This page applies to the following scanner(s): [BCD996XT](#) [BCD396XT](#) [Users Guide](#)

Weather mode

Since the 10 NOAA weather channels now cooperate with the FCC and DHS to alert you of other hazards besides weather, it's important to understand how weather mode works:

- Weather channels cannot be locked out.
- The scanner does not run close call checks in the background while monitoring the weather channels.
- *Normal weather scan* treats the weather channels like any other channel: the scanner cycles through the channels, pausing whenever it detects a signal. In normal weather scan, the scanner does not react to alert tones on these channels.
- With a *Weather alert scan*, the scanner checks the weather channels for alert tones and only opens squelch when it detects one. You can program the scanner to filter alerts by region through the Weather Alert menu.
- With a *Weather alert priority scan*, the scanner checks the weather channels every 5 seconds when you are in scan or search mode or close call mode. Weather alert priority scan does not function in the search and store modes ([Search and Store](#) or [Close Call Auto Store](#)), in [Tone Out mode](#), or in [Band Scope mode](#).

Weather menus

- [BCD396XT and BCD996XT WX Operation](#) menu
- [BC346XT and BCT15X WX Operation](#) menu

This page applies to the following scanner(s): [BCD996XT](#) [BCT15X](#) [BCD396XT](#)
[BCD346XT Users Guide](#)

To determine whether the information on this page applies to your scanner, see the tags at the bottom of the page.

This menu lets you create channels and edit existing channels. All existing channels are listed in alphabetical order: select the channel you want to edit, or select New Channel to create a new one. You can have up to up to 1000 channels in a conventional system and 500 channels in a trunked system.

When you create a new channel, the scanner prompts you to enter the frequency (in a conventional system) or the Talk Group ID (in a trunked system) for the channel: you can edit these at any time through this menu.

- [Edit Frequency \(conventional systems\)](#)
- [Edit Talk Group ID \(trunked systems\)](#)
- [Global channel options](#)
 - [Edit Name](#)
 - [Set Number Tag](#)
 - [Set Priority](#)
 - [Set Alert](#)
 - [Set Lockout](#)
 - [Volume Offset](#)
 - [Copy Channel](#)
 - [Delete Channel](#)
 - [New Channel](#)
- [Conventional system channel options](#)
 - [Set CTCSS/DCS](#)
 - [Set Modulation](#)
 - [Set Attenuator](#)

Edit Frequency (conventional systems)

Enter a valid frequency for this band. If the frequency is invalid or if it already exists, the scanner sounds an error tone and prompts you enter the frequency again.

Edit Talk Group ID (trunked systems)

- BC346XT Edit Talk Group ID? menu

Global channel options

You have the following options when editing channels in any system:

Edit Name

Enter a name or edit the existing one. Names can be 16 characters long, and they can contain upper and lower case letters, punctuation, and spaces. Turn the **SELECT-VOLUME-SQUELCH** knob on the handheld scanners or the **SCROLL / FUNCTION** knob on mobile scanners to choose the character you want, then press **6** (right cursor) to move the cursor to the next character.

Set Number Tag

Assign a number to this system or channel that you can use to tune directly to a specific channel. Choose a number from 0 to 999. (For more information, see [Number Tags](#).)

Set Priority

Choose whether this channel should be flagged as a priority channel so the scanner checks it during priority scans and searches.

Set Alert

This menu lets you configure whether the scanner triggers an alert tone and light whenever this channel or frequency becomes active. (Compare this to the system setting [Emergency Alert](#), which triggers a tone and light when a Talk Group contains an emergency flag.) The available options for [Set Alert Tone](#) and [Set Alert Light](#) are common to both types of alerts.

Set Lockout

Decide whether you want to lock out a system, site, or channel so the scanner will ignore it during Scan and Search modes. If you lock out a system or site, all channels within that system or site will be locked out. Choose one of the following options:

- *Unlocked*: The system, site, or channel is not locked out.
- *Temporary L/O*: The system, site or channel is locked out until you turn the scanner off and back on.
- *Lockout*: The system, site, or channel is permanently locked out.

Volume Offset

The scanner can automatically adjust the volume when it tunes to this channel or frequency. Enter one of the following options:

Softer	No Change	Louder
-3, -2, - 1	0 (default)	+1, +2, +3

Copy Channel

Copy this channel and all its settings into the buffer. When a channel is stored in the buffer, the scanner adds *Paste Channel* to the bottom of the *Program Channel* menu whenever you are editing a compatible system (that is, a system that is the same type as the one you copied the channel from).

Delete Channel

Delete this frequency or channel and all associated settings.

New Channel

Create a new channel.

Conventional system channel options

You have the following additional options when editing channels in a conventional system:

Set CTCSS/DCS

(Conventional systems only) Choose one of the following CTCSS/DSC options for this channel:

Off	The scanner ignores all CTCSS and DCS tones and opens squelch on any signal.
Search	The scanner displays any received CTCSS and DCS tones, but it opens squelch on any signal.
CTCSS	The scanner prompts you to enter a CTCSS code; it will only open squelch if the received signal contains a CTCSS tone that matches the one you enter here.
DCS	The scanner prompts you to enter a DCS code; it will only open squelch if the received signal contains a DCS tone that matches the one you enter here.
Set Lockout	The scanner prompts you to enter a CTCSS or DCS code that you want to lockout for this channel. The scanner will not open squelch if the received signal contains a matching CTCSS or DCS tone.

Set Modulation

Select what type of modulation the scanner should use for this frequency or channel. (Only the modulation types available for this frequency or channel are displayed.)

Auto	The scanner uses the default modulation type for this frequency's band.
AM	The scanner treats the frequency as an AM band.
NFM	The scanner treats the frequency as a Narrowband FM band.
FM	The scanner treats the frequency as an FM band.
WFM	The scanner treats the frequency as a Wideband FM band.
FMB	The scanner treats the frequency as an FM broadcast band.

Set Attenuator

Turn on attenuation to reduce the signal strength by 20 dB. You can turn on attenuation for individual frequencies and channels or for entire sites. If you turn on attenuation for a site, all frequencies within that site will be attenuated.

This page applies to the following scanner(s): [BCT15X BC346XT Users Guide](#)

To determine whether the information on this page applies to your scanner, see the tags at the bottom of the page.

All Talk Group IDs must be in the proper format for each system type.

- [Motorola Type I Systems](#)
- [Motorola Type II Systems](#)
- [EDACS Wide or Narrow Systems](#)
 - [AFS format](#)
- [I-Call system \(Motorola or EDACS\)](#)
- [LTR systems](#)

Motorola Type I Systems

Enter the Talk Group ID in the following format:

BFFF-SS

- B = Block # (1 digit)
- F = Fleet # (2-3 digits)
- S = Sub-Fleet # (1-2 digits)

Press the decimal key to enter the hyphen.

(If you try to enter a hexadecimal TGID for a Type I system, the scanner treats the entry as a decimal number.)

Motorola Type II Systems

- Decimal format: Enter the TGID in numbers only, up to 5 digits
- Hexadecimal format: up to 3 characters

Select the first Hex character (0 through F), then move the cursor to the right and select the second character. Press yes when you're finished.

EDACS Wide or Narrow Systems

AFS format

Enter the Talk Group ID in the following format:

AA-FFS

- A = Agency # (00 - 15)
- F = Fleet # (00 - 15)
- S = Sub-fleet # (0 - 7)

Press the decimal key to enter the hyphen.

Enter 0 for the Sub-Fleet # to treat it as a wildcard (any Sub-Fleet within that Fleet). You can enter 000 for the Fleet # and Sub-Fleet # to treat them both as wildcards as long as the Agency # is not 00.

I-Call system (Motorola or EDACS)

Enter the Talk Group ID in the following format:

i { ID number }

Press the decimal key to enter the lower-case i, then enter the ID number.

LTR systems

Enter the Talk Group ID in the following format:

AHHUUU

- A = Area Code (0 or 1)
- H = Home repeater (01 - 20)
- U = User ID (000 - 254)

This page applies to the following scanner(s): [BC346XT](#) [BCT15X](#) [Users Guide](#)

Site Options

To determine whether the information on this page applies to your scanner, see the tags at the bottom of the page.

When you create a new site, the scanner automatically assigns a default site name using the following pattern

Site XXX-YYY TTT

where *XXX* is a 3-digit system index number, *YYY* is a sequential site number (1 through 256), and *TTT* is one of the following 3-letter type codes:

- *EDC* (any EDACS system)
- *LTR* (any LTR system)
- *MOT* (any Motorola system)

- [Global site options](#)
 - [Edit Name](#)
 - [Set Quick Key](#)
 - [Set Startup Key](#)
 - [Set Frequencies](#)
 - [Set Modulation](#)
 - [Set Attenuator](#)
 - [Set Lockout](#)
 - [Set Hold Time](#)
 - [Set LocationInfo](#)
 - [Delete Site](#)
 - [New Site](#)

- [Options available for Motorola systems](#)
 - [Edit Band Plan](#)
 - [Set C-Ch Only](#)

- [Options available for EDACS systems](#)
 - [Set Site Type](#)

Global site options

You have the following options for all sites:

Edit Name

Enter a name or edit the existing one. Names can be 16 characters long, and they can contain upper and lower case letters, punctuation, and spaces. Turn the **SELECT-VOLUME-SQUELCH** knob on the handheld scanners or the **SCROLL / FUNCTION** knob on mobile scanners to choose the character you want, then press **6** (right cursor) to move the cursor to the next character.

Set Quick Key

Assign this system or site to a Quick Key so you can easily enable or disable it during scanning. Enter a number from 0 to 99; tap **NO** (the decimal point) if you don't want to assign this system or site to a Quick Key. (For more information, see [Quick Keys](#).)

Set Startup Key

Assign this system or site to a Startup Key so you can lock or unlock it during power up. Enter a number from 0 to 9; tap **NO** (the decimal point) if you don't want to assign this system or site to a Startup Key. (For more information, see [Startup Keys](#).)

Set Frequencies

Use this menu to program frequencies for this site.

Set Modulation

Select what type of modulation the scanner should use for this frequency or channel. (Only the modulation types available for this frequency or channel are displayed.)

Auto	The scanner uses the default modulation type for this frequency's band.
NFM	The scanner treats the frequency as a Narrowband FM band.
FM	The scanner treats the frequency as an FM band.

Set Attenuator

Turn on attenuation to reduce the signal strength by 20 dB. You can turn on attenuation for individual frequencies and channels or for entire sites. If you turn on attenuation for a site, all frequencies within that site will be attenuated.

Set Lockout

Decide whether you want to lock out a system, site, or channel so the scanner will ignore it during Scan and Search modes. If you lock out a system or site, all channels within that system or site will be locked out. Choose one of the following options:

- *Unlocked*: The system, site, or channel is not locked out.
- *Temporary L/O*: The system, site or channel is locked out until you turn the scanner off and back on.
- *Lockout*: The system, site, or channel is permanently locked out.

Set Hold Time

Set the minimum number of seconds the scanner should spend checking this system or site even if there is no traffic on any channel. (The scanner always checks each channel in a system or site once even if the hold time is set to 0 seconds.) Select the number of seconds from 0 through 255 (2 is the default).

[Set LocationInfo](#)

Use this menu to program location information for this site.

Delete Site

Delete this site and all its settings; this includes any frequencies.

New Site

Create a new site.

Options available for Motorola systems

The following options are available when you are editing a site within a Motorola system.

[Edit Band Plan](#)

Set C-Ch Only

If you activate this feature, you can monitor this system by programming only the control channel (instead of programming the control channel and all the voice channels).

When you use C-Ch Only, you will not be able to use the Trunking Channel Activity Indicators, but you will save memory.

Options available for EDACS systems

The following options are available when you are editing a site within an EDACS system.

Set Site Type

Select *Wide (standard)* or *Narrow* according to the EDACS site type.

[System menu](#) / [Main menu](#)

This page applies to the following scanner(s): [BCT15X BC346XT Users Guide](#)

To determine whether the information on this page applies to your scanner, see the tags at the bottom of the page.

- [Tone-Out Standby](#)
- [Tone-Out Setup](#)
 - [Edit Name](#)
 - [Set Frequencies](#)
 - [Set Tone](#)
 - [Set Delay Time](#)
 - [Set Alert](#)
 - [Set Alert Tone](#)
 - [Set Alert Light](#)
- [Tone-Out Search](#)

Tone-Out Standby

Check the tone out channels for paging tones, according to each channel's individual settings.

Tone-Out Setup

This menu lets you configure the 10 tone-out channels. Select the channel you want to edit from the list, then set the frequency, tone, and other options for that channel.

Edit Name

Enter a name or edit the existing one. Names can be 16 characters long, and they can contain upper and lower case letters, punctuation, and spaces. Turn the **SELECT-VOLUME-SQUELCH** knob on the handheld scanners or the **SCROLL / FUNCTION** knob on mobile scanners to choose the character you want, then press **6** (right cursor) to move the cursor to the next character.

[Set Frequencies](#)

Use this menu to program frequencies for this Tone Out channel.

Set Tone

This menu lets you configure the type of tone out search. Select the tone you want to edit (*Edit Tone A* or *Edit Tone B*), then set the frequency for that tone. Enter a frequency between 250 Hz and 3500 Hz, or set the frequency to 0 Hz. (See [Tone A and Tone B Settings](#) for more information.)

Set Delay Time

Set the number of seconds the scanner should wait after a transmission stops before moving on to the next channel. Select *0*, *1*, *2* (default), *5*, *10*, or *30 seconds* . To have the scanner wait for your input before moving on to the next channel, select *Infinite* .

Set Alert

Decide whether the scanner triggers an alert tone and light when it detects a tone on this channel. (Compare this to the system setting [Emergency Alert](#), which triggers a tone and light when a Talk Group contains an emergency flag.) The available options for [Set Alert Tone](#) and [Set Alert Light](#) are common to both types of alerts.

[Set Alert Tone](#)

[Set Alert Light](#)

Tone-Out Search

You can set the scanner to search for and identify the tones used in tone-outs. To do so, you set both the A and B tones to a value of "0". See [Tone A and Tone B Settings](#) for more information.

This page applies to the following scanner(s): [BCT15X BC346XT Users Guide](#)

WX Operation

To determine whether the information on this page applies to your scanner, see the tags at the bottom of the page.

This menu lets you configure how the scanner operates in Weather (WX) mode and Weather Alert (WX Alert) mode.

- [Weather Scan](#)
- [Weather Alert](#)
 - [Alert Only](#)
 - [SAME 1 through SAME 5](#)
 - [All FIPS](#)
- [Program SAME](#)
 - [Edit Name \(SAME\)](#)
 - [Edit County](#)
- [Set Delay Time](#)
- [Set Attenuator](#)
- [WX Alt Priority](#)

Weather Scan

Start a normal weather scan. In normal weather scan mode, the scanner does not react to alert tones on weather channels.

Weather Alert

Choose how you want the scanner to filter any alerts it detects on the weather channels:

Alert Only

The scanner responds to all alert tones detected on the weather channels, regardless of region or hazard level. When an alert is detected, the scanner sounds an alert siren and opens squelch on the weather channel.

SAME 1 through SAME 5

Choose one of 5 programmable regions to filter alerts by. The scanner only responds to alerts that affect the selected region you select here, and only if the hazard level is an Advisory, a Watch, or a Warning. When an alert is detected, the scanner sounds an alert siren, displays available information (hazard level, type, etc.) on the screen, and opens squelch on the weather channel.

All FIPS

The scanner responds to alerts regardless of region, but only if the hazard level is an Advisory, a Watch, or a Warning. When an alert is detected, the scanner sounds an alert siren, displays available information (hazard level, type, etc.) on the screen, and opens squelch on the weather channel.

Program SAME

You can pre-program up to 5 regions for filtering hazard alerts, then select one of these regions on the Weather Alert menu. The scanner will only respond to alerts in the selected region.

Edit Name (SAME)

Enter the name you want to use for each region. The default names are SAME 1 through SAME 5.

Edit County

Enter the designated FIPS code for up to 8 counties. To edit a FIPS code, select it from the list. Use the number keypad to enter the 6-digit code, and press YES when you're finished. If you don't enter all 6 digits, the scanner can't store the code and displays it as "-----" on the county list.

(See [Introduction to SAME messages](#) for more information.)

Set Delay Time

Set the number of seconds the scanner should wait after a transmission stops before moving on to the next channel. Select *0*, *1*, *2* (default), *5*, *10*, or *30 seconds*.

To have scanner leave the channel after a designated number of seconds whether the transmission stops or not, select one of the negative values. Choose *-10* seconds to have the scanner leave the channel after 10 seconds even if the transmission is still going on; choose *-5 seconds* or *-2 seconds* to have the scanner leave after 5 seconds or 2 seconds, respectively.

Set Attenuator

Turn on attenuation to reduce the signal strength by 20 dB. You can turn on attenuation for individual frequencies and channels or for entire sites. If you turn on attenuation for a site, all frequencies within that site will be attenuated.

WX Alt Priority

Select *On* if you want the scanner to check the weather channels in the background during Scan, Search, or Close Call mode. The scanner can't run Weather Alert Priority check in Search and Store, Close Call Auto Store, or Tone-Out modes.

This page applies to the following scanner(s): [BCT15X BC346XT Users Guide](#)

To determine whether the information on this page applies to your scanner, see the tags at the bottom of the page.

System options vary depending on the system type.

- [Global system options](#)
 - [Set Number Tag](#)
 - [Set Delay Time](#)
- [Conventional system options](#)
 - [Set Quick Key](#)
 - [Set Startup Key](#)
 - [Set Lockout](#)
 - [Set Hold Time](#)
- [Trunked system options](#)
 - [ID Scan/Search](#)
 - [Priority ID Scan](#)
 - [Emergency Alert](#)
 - [Set ID Format \(DEC/HEX\) or \(AFS/DEC\)](#)
 - [Rvw ID:Srch L/O](#)
 - [Clr All L/O IDs](#)
- [Motorola system options](#)
 - [Edit Fleet Map](#)
 - [Set Status Bit](#)
 - [Set End Code](#)

Global system options

The following options are available for all types of systems.

Set Number Tag

Assign a number to this system or channel that you can use to tune directly to a specific channel. Choose a number from 0 to 999. (For more information, see [Number Tags](#).)

Set Delay Time

Set the number of seconds the scanner should wait after a transmission stops before moving on to the next channel. Select *0*, *1*, *2* (default), *5*, *10*, or *30 seconds*.

To have scanner leave the channel after a designated number of seconds whether the transmission stops or not, select one of the negative values. Choose *-10* seconds to have the scanner leave the channel after 10 seconds even if the transmission is still going on; choose *-5 seconds* or *-2 seconds* to have the scanner leave after 5 seconds or 2 seconds, respectively.

Conventional system options

The following options are available when you're editing a conventional system:

Set Quick Key

Assign this system or site to a Quick Key so you can easily enable or disable it during scanning. Enter a number from 0 to 99; tap NO (the decimal point) if you don't want to assign this system or site to a Quick Key. (For more information, see [Quick Keys](#).)

Set Startup Key

Assign this system or site to a Startup Key so you can lock or unlock it during power up. Enter a number from 0 to 9; tap NO (the decimal point) if you don't want to assign this system or site to a Startup Key. (For more information, see [Startup Keys](#).)

Set Lockout

Decide whether you want to lock out a system, site, or channel so the scanner will ignore it during Scan and Search modes. If you lock out a system or site, all channels within that system or site will be locked out. Choose one of the following options:

- *Unlocked*: The system, site, or channel is not locked out.
- *Temporary L/O*: The system, site or channel is locked out until you turn the scanner off and back on.
- *Lockout*: The system, site, or channel is permanently locked out.

Set Hold Time

Set the minimum number of seconds the scanner should spend checking this system or site even if there is no traffic on any channel. (The scanner always checks each channel in a system or site once even if the hold time is set to 0 seconds.) Select the number of seconds from 0 through 255 (2 is the default).

Trunked system options

The following options are available when you're editing a trunked system:

ID Scan/Search

Choose whether the scanner only checks the Talk Group IDs that you program (*ID Scan*) or checks all the Talk Group IDs it can find (*ID Search*) when scanning this site.

Priority ID Scan

Choose *On* to have the scanner check any priority-labeled channels in this system during Priority Scan mode. Choose *Off* if you want the scanner to ignore this system when scanning priority channels.

Emergency Alert

This menu lets you configure whether the scanner triggers an alert tone and light when it detects an emergency flag within an active Talk Group. (Compare this to the channel setting [Set Alert](#), which can trigger an alert tone and light whenever a channel becomes active.) The settings for [Set Alert Tone](#) and [Set Alert Light](#) are common to both types of alerts.

Set ID Format (DEC/HEX) or (AFS/DEC)

Trunked systems have three different formats for the Talk Group ID, but not all formats are used by each system type. Choose the Talk Group ID format used by this system":

- *Dec* : The system uses a decimal (base 10) format for the Talk Group IDs (available for all trunked systems)
- *Hex* : The system uses a hexadecimal (base 16) format for the Talk Group IDs (available for Motorola systems only)

- *AFS* : The system uses the Agency-Fleet-Subfleet format for the Talk Group IDs (available for EDACS wide or narrow systems only)

Rvw ID:Srcch L/O

This feature displays a list of all locked out Talk Group IDs. If you want to unlock a Talk Group ID, just select it from the list and press **YES** .

Clr All L/O IDs

Choose yes to unlock all the Talk Group IDs in this system or site. (Choose no to cancel and go back to the previous screen.)

Motorola system options

The following options are available when only when you're editing a Motorola system:

Edit Fleet Map

(Motorola Type I or Hybrid systems only) This menu lets you choose one of the 16 pre-programmed fleet maps; select *Custom* to manually program your own fleet map information. (See [Motorola fleet maps](#) for more information.)

Set Status Bit

Choose *Yes* to have the scanner check the status bit in each TalkGroup? ID, or choose *Ignore* to ignore all status bits in this system.

Set End Code

Choose *Yes* to have the scanner respond to the transmission end code, or choose *Ignore* to have the scanner wait for the carrier signal to drop.

This page applies to the following scanner(s): [BCT15X BC346XT Users Guide](#)



Hold mode







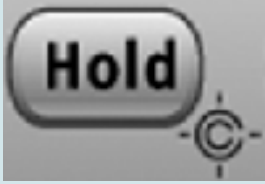

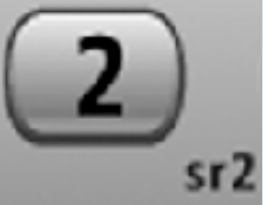
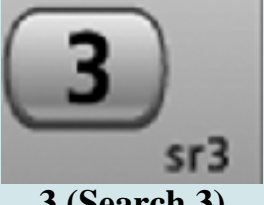

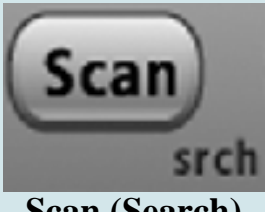
Please note that these pages are meant as general instructions. While most of the information here applies to all scanners, some options may not be available on certain scanner models. Model-specific options are indicated in the text.

Hold mode lets you edit the current frequency, system, site, or channel. You can access these functions by using the different key operations:

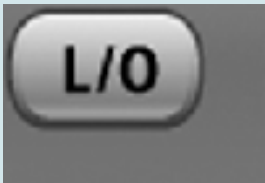
- [Key operation in Hold mode](#)
- [Reading the displays in Hold mode](#)
 - [Conventional system display](#)
 - [Trunked system display](#)
 - [Service search with scan hold display](#)

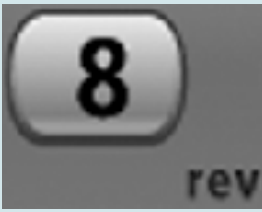
Key operation in Hold mode

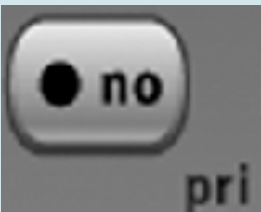
Key Name (2nd operation)				
Action on:	Hold (Close call)	1 (Search 1)	2 (Search 2)	3 (Search 3)
Tap	Enter Hold mode.	Enter the number on the key		
FUNCTION + Tap	Enter Close Call mode.	NA	NA	NA
FUNCTION + Press & hold	Enter Close Call Only mode.	Start the Quick Search assigned to this key.		

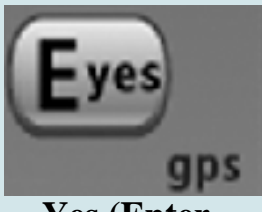
Key Name (2nd operation) Action on:	 Scan (Search)	 4 (IF exchange)	 5 (Volume offset)	 6 (Display mode)
Tap	Enter Scan mode.	NA	NA	NA
FUNCTION + Tap	Enter Search mode.	Switch to an alternate intermediate frequency to avoid interference.	Change the volume offset for the current signal.	Rotate through the three available display modes.
Key Name (2nd operation) Action on:	 Lockout	 7 (Attenuation)	 8 (Reverse freq.)	 9 (Modulation)
FUNCTION + Tap	NA	Toggle the attenuator state for the current signal.	NA	Change the modulation type.
FUNCTION + Press & hold	Unlock all items regardless of type.	Toggle the attenuator state for all signals.	Switch to the reverse repeater frequency of the current signal.	NA
Key Name (2nd operation) Action on:	 Backlight (Power, Lock)	 No (Decimal, Priority)	 0 (Weather)	 Yes (Enter, GPS)

Tap	Turn on the LCD backlight.	During a system message: Cancel the message and exit that screen.	NA	Save the current frequency into memory.
Press & hold	Turn the scanner on or off.	NA	NA	NA
FUNCTION + Tap	Lock or unlock the keypad.	Turn Priority scan on or off.	Change the weather alert priority setting.	Enter GPS mode.
FUNCTION + Press & hold	NA	NA	Enter Weather mode.	NA

Reading the displays in Hold mode

The display information in Hold mode varies depending on the type of system the scanner is Holding on.

Conventional system display

When the scanner is holding on a conventional system, it displays the following screens:

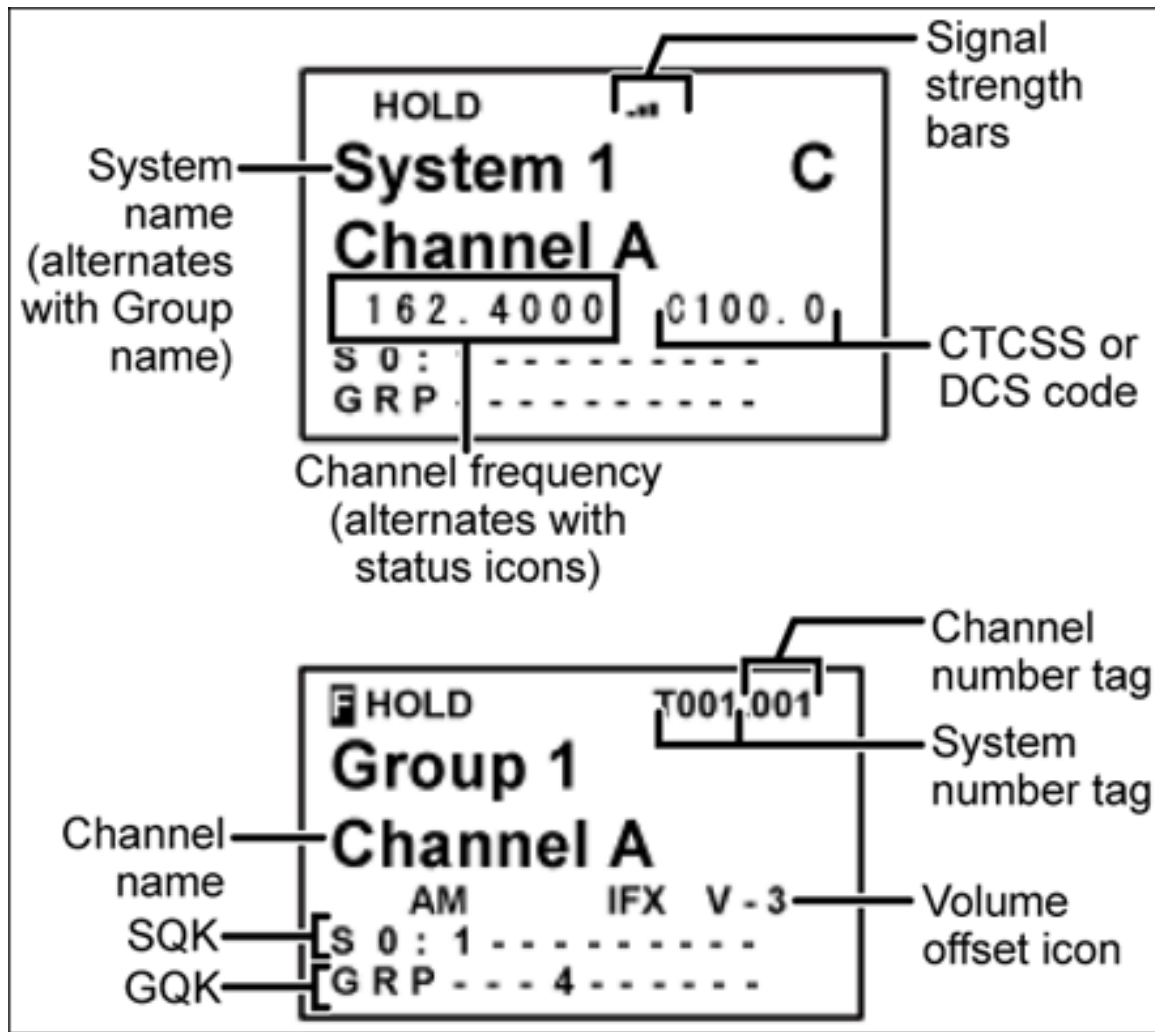

- To see the alternate information on the display at the top, cycle through the display modes.
- To see the display at the bottom of the diagram, tap **FUNCTION** .
- For an explanation of System and Channel Number Tags, see [Number Tags](#).
- For an explanation of the volume offset level, see [Volume Offset](#).

Trunked system display

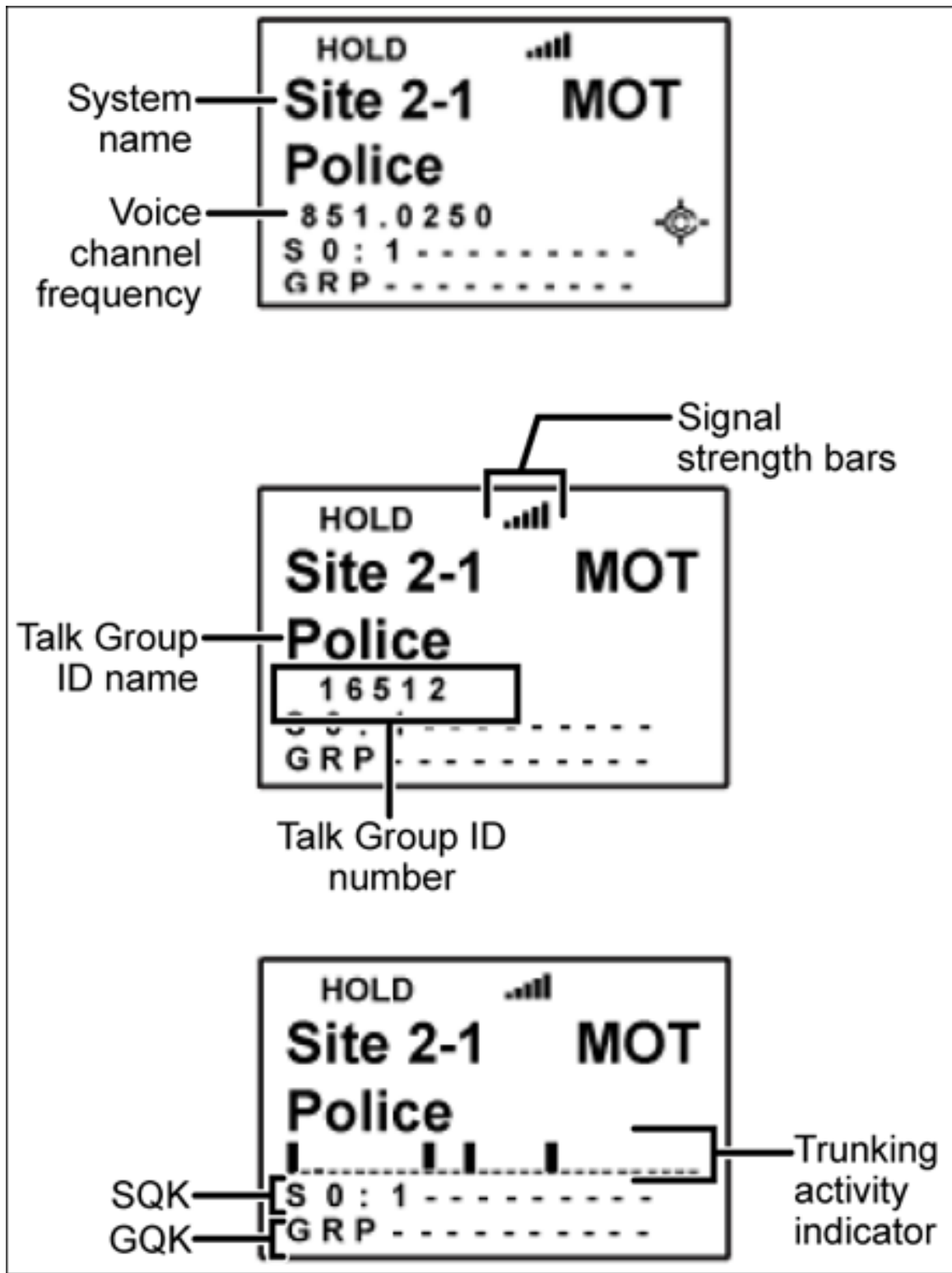

Service search with scan hold display

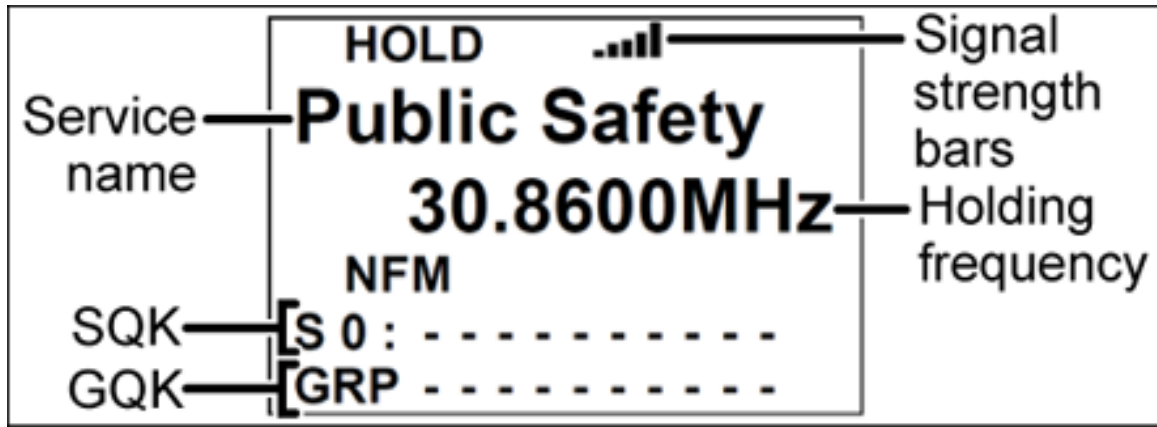

This page applies to the following scanner(s): [BCD396XT](#) [BC346XT](#) [Users Guide](#)



Key Safe Mode







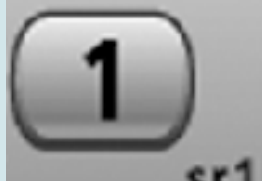
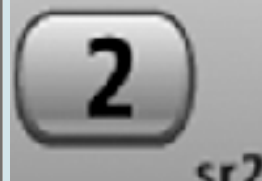

Key Safe mode locks out the programming menu and more advanced functions so the user can't accidentally "break" the scanner. This mode is ideal for any situation where you want another person to be able to use the scanner without changing any of the settings.

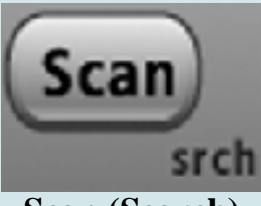
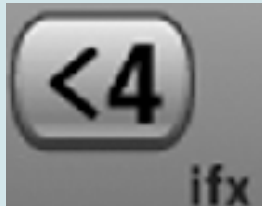
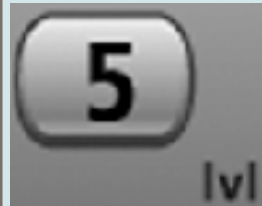
To turn Key Safe mode on (or off)

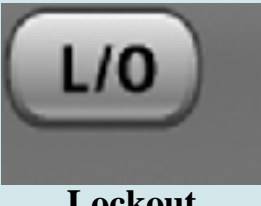
- Turn the scanner off.
- Press and hold **FUNCTION** while you turn the scanner back on.
- The scanner display shows *Key Safe Mode On* (or *Key Safe Mode Off*), then returns to the operation it was performing when you turned it off.
- While Key Safe mode is on, **MENU** is disabled along with the key combinations described in the table below.
- When you try to use a disabled key combination, the scanner display shows *Key Safe Mode. Press FUNC while Power On for Full Operation* .

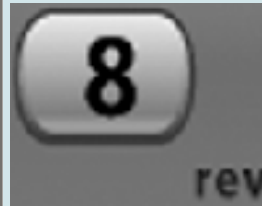
The table below shows which key combinations are disabled and which ones operate normally (depending on the operating mode the scanner is in):

Key Name (2nd operation) Action on:	 Hold (Close call)	 1 (Search 1)	 2 (Search 2)	 3 (Search 3)
Tap	Normal operation			
Press & hold	Normal operation			
FUNCTION + Tap	Normal operation	Disabled		
FUNCTION + Press & hold	Disabled			

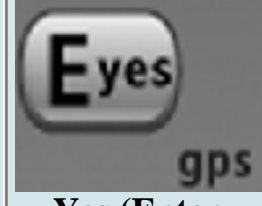
Key Name (2nd operation)				
Action on:	Scan (Search)	4 (IF exchange)	5 (Volume offset)	6 (Display mode)
Tap	Resume function only.	Normal operation.		
FUNCTION + Tap	Disabled			Normal operation
Key Name (2nd operation)				
Action on:	Lockout	7 (Attenuation)	8 (Reverse freq.)	9 (Modulation)
Tap	Normal operation.			
Double tap	Normal operation.			
Press & hold	Disabled	Normal operation.		
FUNCTION + Tap	Disabled			
FUNCTION + Double tap	Disabled			
FUNCTION + Press & hold	Disabled			
Key Name (2nd operation)				
Action on:	Backlight (Power, Lock)	No (Decimal, Priority)	0 (Weather)	Yes (Enter, GPS)
Tap	Normal operation			Disabled

Press & hold	Normal operation		Disabled
FUNCTION + Tap	Normal operation	Disabled	
FUNCTION + Press & hold	Normal operation		Disabled

This page applies to the following scanner(s): [BCD396XT](#) [BC346XT](#) [Users Guide](#)

Settings

To determine whether the information on this page applies to your scanner, see the tags at the bottom of the page.

- [Set Backlight](#)
 - [Set Mode](#)
 - [Set Dimmer](#)
 - [Set Color](#)
- [Adjust Key Beep](#)
- [Battery Option](#)
 - [Set Battery Save](#)
 - [Set Charge Time](#)
- [Adjust Audio AGC](#)
- [Adjust Contrast](#)
- [Set C-CH Output](#)
- [Set GPS Format](#)
 - [Set POS Format](#)
 - [Set Time Format](#)
 - [Set Time Zone](#)
 - [Set Unit](#)
- [Set Serial Port](#)
- [Band Defaults](#)
 - [Set Modulation](#)
 - [Set Step](#)
- [P25 LP Filter](#)
- [See Scanner Info](#)
 - [% Memory Used](#)
 - [Firmware Version](#)

Set Backlight

This menu lets you configure the display and key backlight.

Set Mode

Choose how you want the backlight to operate:

10 sec	The scanner keeps the backlight on for 10 seconds after the last operation.
30 sec	The scanner keeps the backlight on for 30 seconds after the last operation.
Squelch	The scanner turns on the backlight when a signal breaks squelch.
Keypress	The scanner turns on the backlight when you press a key.
Infinite	The scanner leaves the backlight on all the time.

Set Dimmer

Select the brightness of the backlight. Your options are high (brightest), middle, and low (dimmiest).

Set Color

Select the color of the backlight. Your options are blue, red, magenta, green, cyan, yellow, and white.

Adjust Key Beep

Select the volume level (Level 1 through Level 15) you want the keybeep to use, or select *Auto* to have the scanner sound the keybeep without changing the volume. If you don't want the scanner to beep when you press the keys, select *Off*.

Battery Option

This menu lets you configure the advanced battery control features:

Set Battery Save

Turn the battery save feature on or off.

Set Charge Time

Enter the amount of time you want the battery to draw power while charging.

Adjust Audio AGC

Configure how the scanner handles the *Automatic Gain Control (AGC)* for Analog and Digital signals:

Parameter	Definition	Analog settings	Digital settings
Response Time	How frequently the AGC factor updates. Decrease this value to make AGC respond faster (but this could result in pumping). Increase this value to make AGC respond more slowly.	-4 to +6 (default=0)	-8 to +8 (default=0)
Reference Gain	The reference level that AGC attempts to adjust the volume to. If digital and analog volumes don't match, adjust this parameter.	-5 to +5 (default=0)	-5 to +5 (default=0)
Gain Range	The total dynamic range of the AGC adjustments. A larger value allows a wider variation in volume.	0 to 15	NA

Adjust Contrast

Select one of the 15 available contrast levels for the display. As you scroll through the options, the display adjusts to the highlighted contrast level; press **YES** when you see the display contrast you want to use.

Set C-CH Output

Choose how you want the scanner to handle control channel data:

- *Off* : The scanner will not output the control channel data.
- *On* : The scanner will output the control channel data.
- *Extend* : The scanner will output the control channel data along with any description.

Set GPS Format

Configure how the scanner displays position coordinates, time, and units during GPS operation:

Set POS Format

Select how the scanner displays longitude and latitude:

- *DMS: DDD° MM' SS.ss* : Display coordinates in degrees (DDD), minutes (MM), and seconds (SS.ss).
- *DEG: DDD.ddddd* : Display coordinates as decimal degrees.

Set Time Format

Select 12H for 12-hour (am/pm) time format or 24H for 24-hour time format.

Set Time Zone

Set the number of hours your local time zone differs from universal time (GMT/UTC). Select from -14 hours to +14 hours in half-hour (0.5 h) increments.

Set Unit

Select the unit used for distance: mile or kilometer (km).

Set Serial Port

Set the baud rate for the scanner's serial port. Choose from *4800*, *9600*, *19200*, *38400*, *57600*, or *115200* bps; select *Off* to disable the serial port.

Band Defaults

Use this menu to change the default modulation and frequency step or spacing used for each band. The scanner displays the list of available bands in the following format:

{Frequency} : {modulation type} / {step}

Select the frequency band you want to edit. The scanner prompts you for the following information:

Set Modulation

Select the type of modulation you want the scanner to use as the default for this band: AM, Narrowband FM (NFM), FM, Wideband FM (WFM), or FM broadcast (FMB).

Set Step

Select the number of kHz between each frequency or channel step: 5.0, 6.25, 7.5, 8.33, 10.0, 12.5, 15.0, 20.0, 25.0, 50.0, or 100.0 khz.

P25 LP Filter

This setting lets you set the scanner to apply a software filter that removes the 4kHz tone you can hear on some P25 systems. Note that turning on this setting increases the CPU load and could slightly degrade P25 decode performance on some systems.

See Scanner Info

This menu lets you see detailed information about the memory and firmware.

% Memory Used

See the percent of overall memory used (*Memory Used*) along with the number of programmed *Systems*, *Sites*, and channels (*CHN*) and the percent of available memory

positions used for each.

Firmware Version

See the firmware version (*Version*) and the serial number (*SN*) of the scanner.

This page applies to the following scanner(s): [BCD396XT Users Guide](#)

Wired Clone

This feature allows you to copy all the settings from one scanner to another of the same model:

1. Use the included data cables to connect the two scanners. Plug each of the cables DB9 connector into one side of a Gender Changer/Null-Modem Adapter.
2. On the scanner you want to copy from, go to the *Wired Clone* menu and select *Master* .
3. On the scanner you want to copy to, go to the *Wired Clone* menu and select *Slave* .

The master scanner checks to make sure the slave is properly connected and ready to receive, then begins the data transfer. **Do not disconnect the data cable or turn off either scanner during the transfer.**

When the transfer is finished, both scanners display a *Complete* message. Reboot the slave scanner to load the new settings.

All settings and data saved on the Slave scanner will be erased!

This page applies to the following scanner(s): [BCD396XT](#) [BCD346XT](#) [Users Guide](#)

To determine whether the information on this page applies to your scanner, see the tags at the bottom of the page.

The *Program System* menu lets you create systems and edit existing systems. All existing systems are listed in alphabetical order: select the system you want to edit, or select *New System* to create a new one.

When you create a new system, the scanner prompts you to select a system type; the system type you select controls what options are available for the system setup. You can't change a system type once the system is created: if you need to change the system type, delete the system and create it all over again as a new system.

The *System Type* options are:

- *MOT* : Use for any Motorola system.
- *EDCS* : Use for any EDACs system. When you select this system type, the scanner prompts you to choose *WIDE/NARROW* or *SCAT* .
- *LT* : Use for any LTR system.
- *Conventional* : Use for any non-trunked system.

REMEMBER: once you select a system type, you cant change it!

- [Edit Name](#)
- [Edit Sys Option](#)
- [Edit Site](#)
- [Edit Group](#)
- [Copy System](#)
- [Delete System](#)
- [New System](#)

Edit Name

Enter a name or edit the existing one. Names can be 16 characters long, and they can contain upper and lower case letters, punctuation, and spaces. Turn the **SELECT-VOLUME-SQUELCH** knob on the handheld scanners or the **SCROLL / FUNCTION** knob on mobile scanners to choose the character you want, then press **6** (right cursor) to move the cursor to the next character.

Edit Sys Option

This menu lets you set the options for each system.

Edit Site

(trunked systems only) This menu lets you create sites and edit existing sites. All existing sites are listed in alphabetical order: select the site you want to edit, or select New Site to create a new one.

Edit Group

This menu lets you create groups and edit existing groups. All existing groups are listed in alphabetical order: select the group you want to edit, or select New Group to create a new one. You can have up to 20 groups in each system.

Copy System

Make a copy of this system and all its settings including all sites, groups, channels, and frequencies. The scanner prompts you to enter a new system name.

Delete System

Delete this system and all its settings; this includes sites, groups, channels, and frequencies.

New System

Create a new system.

This page applies to the following scanner(s): [BCT15X BC346XT Users Guide](#)



BC346XT Hold mode





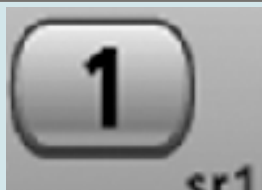
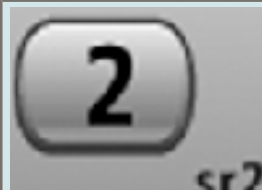
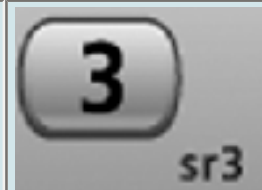
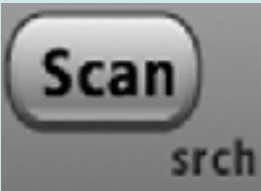
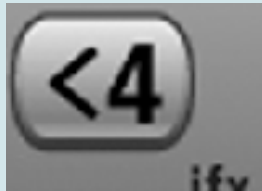
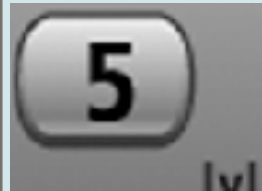

To determine whether the information on this page applies to your scanner, see the tags at the bottom of the page.

Hold mode lets you edit the current frequency, system, site, or channel. You can access these functions by using the different key operations:

- [Key operation in Hold mode](#)
- [Reading the displays in Hold mode](#)
 - [Conventional system display](#)
 - [Trunked system display](#)
 - [Service search with scan hold display](#)

Key operation in Hold mode

Key Name (2nd operation)				
Action on:	Hold (Close call)	1 (Search 1)	2 (Search 2)	3 (Search 3)
Tap	Enter Hold mode.	Enter the number on the key		
FUNCTION + Tap	Enter Close Call mode.	NA	NA	NA
FUNCTION + Press & hold	Enter Close Call Only mode.	Start the Quick Search assigned to this key.		
Key Name (2nd operation)				
Action on:	Scan (Search)	4 (IF exchange)	5 (Volume offset)	6 (Display mode)

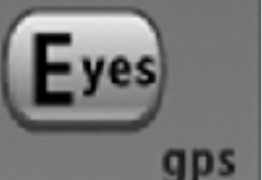
Tap	Enter Scan mode.	Enter the number on the key.		
FUNCTION + Tap	Enter Search mode.	Switch to an alternate intermediate frequency to avoid interference.	Change the volume offset for the current signal.	Rotate through the three available display modes.
Key Name (2nd operation) Action on:	 Lockout	 7 (Attenuation)	 8 (Reverse freq.)	 9 (Modulation)
Tap	Unlock (if locked) or Temporary Lockout (double tap for permanent lockout)	Enter the number on the key.		
FUNCTION + Tap	NA	Toggle the attenuator state for the current signal.	NA	Change the modulation type.
FUNCTION + Press & hold	Unlock all items regardless of type.	Toggle the attenuator state for all signals.	Switch to the reverse repeater frequency of the current signal.	NA
Key Name (2nd operation) Action on:	 Backlight (Power, Lock)	 No (Decimal, Priority)	 0 (Weather)	 Yes (Enter, GPS)

Tap	Turn on the LCD backlight.	During a system message: Cancel the message and exit that screen.	NA	Save the current frequency into memory.
Press & hold	Turn the scanner on or off.	NA	NA	NA
FUNCTION + Tap	Lock or unlock the keypad.	Turn Priority scan on or off.	Change the weather alert priority setting.	Enter GPS mode.
FUNCTION + Press & hold	NA	NA	Enter Weather mode.	NA

Reading the displays in Hold mode

The display information in Hold mode varies depending on the type of system the scanner is Holding on.

Conventional system display

When the scanner is holding on a conventional system, it displays the following screens:

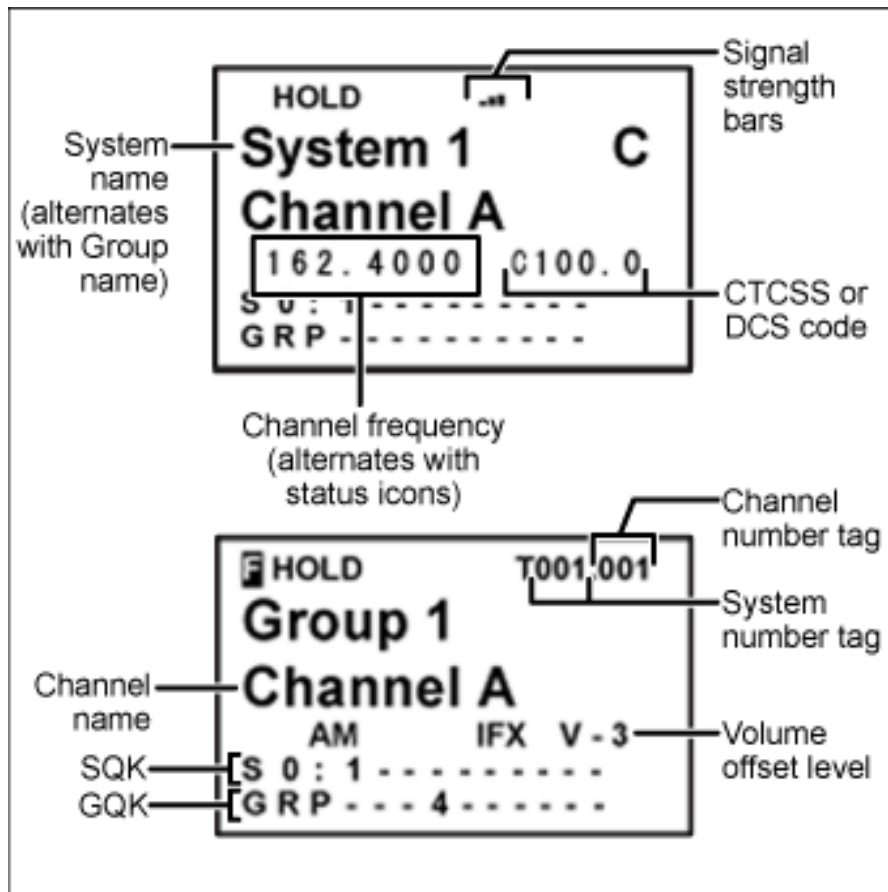

- To see the alternate information on the display at the top, cycle through the display modes.
- To see the display at the bottom of the diagram, tap **FUNCTION**.
- For an explanation of System and Channel Number Tags, see [Number Tags](#).
- For an explanation of the volume offset level, see [Volume Offset](#).

Trunked system display

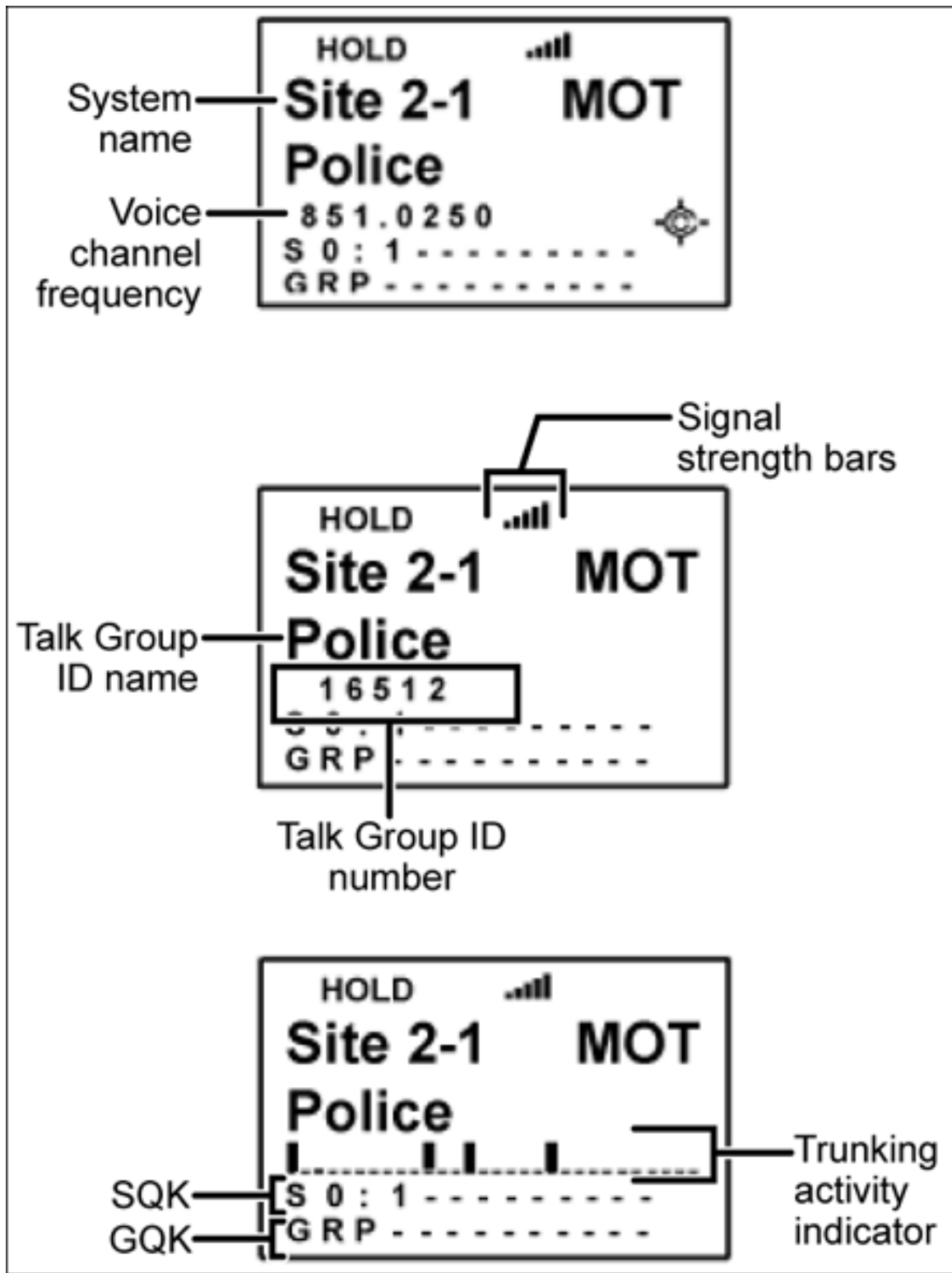

Service search with scan hold display

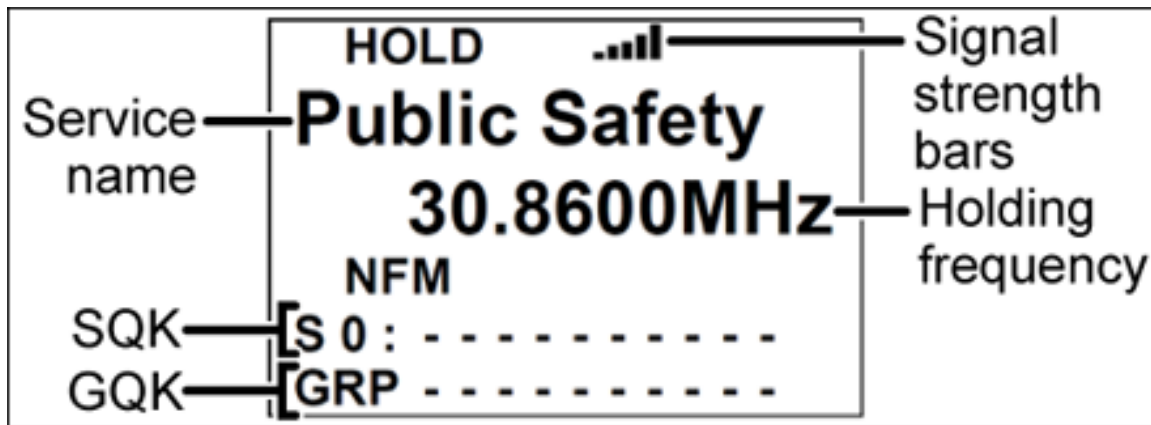

This page applies to the following scanner(s): [BC346XT Users Guide](#)

BC346XT Search for...

To determine whether the information on this page applies to your scanner, see the tags at the bottom of the page.

Use this menu to start a search, to change the options for the three different types of searches, and program the 3 search keys.

- [Service Search](#)
- [Edit Service](#)
 - [Set Delay Time](#)
 - [Set Attenuator](#)
 - [Search with Scan](#)
- [Custom Search](#)
- [Edit Custom](#)
 - [Edit Name](#)
 - [Edit Srch Limit](#)
 - [Set Delay Time](#)
 - [Set Modulation](#)
 - [Set Attenuator](#)
 - [Set Step](#)
 - [Set C-Ch Only](#)
 - [Set MOT BandPlan](#)
 - [Search with Scan](#)
- [Search and Store](#)
- [Set Search Key](#)

Service Search

Start a search of one of the 12 preset service bands. Choose from *Public Safety, News, HAM Radio, Marine, Railroad, Air, CB Radio, FRS/GMRS/MURS, Racing, FM Broadcast, Military Air, or Special* .

Edit Service

This menu lets you change the default settings for the 12 preset service bands. Select the service you want to edit from the list, then set the following options:

Set Delay Time

Set the number of seconds the scanner should wait after a transmission stops before moving on to the next channel. Select *0*, *1*, *2* (default), *5*, *10*, or *30 seconds*.

To have scanner leave the channel after a designated number of seconds whether the transmission stops or not, select one of the negative values. Choose *-10* seconds to have the scanner leave the channel after 10 seconds even if the transmission is still going on; choose *-5 seconds* or *-2 seconds* to have the scanner leave after 5 seconds or 2 seconds, respectively.

Set Attenuator

Turn on attenuation to reduce the signal strength by 20 dB. You can turn on attenuation for individual frequencies and channels or for entire sites. If you turn on attenuation for a site, all frequencies within that site will be attenuated.

Search with Scan

Custom Search

Start a search of the 10 custom search ranges.

Edit Custom

This menu lets you program the ten custom search ranges. Select the custom search you want to edit from the list, then set the following options:

Edit Name

Enter a name or edit the existing one. Names can be 16 characters long, and they can contain upper and lower case letters, punctuation, and spaces. Turn the **SELECT-VOLUME-SQUELCH** knob on the handheld scanners or the **SCROLL / FUNCTION**

knob on mobile scanners to choose the character you want, then press **6** (right cursor) to move the cursor to the next character.

Edit Srch Limit

Change the range of frequencies covered by this custom search. The scanner prompts you to input the lower frequency limit and then the upper frequency limit.

Set Delay Time

Set the number of seconds the scanner should wait after a transmission stops before moving on to the next channel. Select *0*, *1*, *2* (default), *5*, *10*, or *30 seconds*.

To have scanner leave the channel after a designated number of seconds whether the transmission stops or not, select one of the negative values. Choose *-10* seconds to have the scanner leave the channel after 10 seconds even if the transmission is still going on; choose *-5 seconds* or *-2 seconds* to have the scanner leave after 5 seconds or 2 seconds, respectively.

Set Modulation

Select what type of modulation the scanner should use for this frequency or channel. (Only the modulation types available for this frequency or channel are displayed.)

Auto	The scanner uses the default modulation type for this frequency's band.
AM	The scanner treats the frequency as an AM band.
NFM	The scanner treats the frequency as a Narrowband FM band.
FM	The scanner treats the frequency as an FM band.
WFM	The scanner treats the frequency as a Wideband FM band.
FMB	The scanner treats the frequency as an FM broadcast band.

Set Attenuator

Turn on attenuation to reduce the signal strength by 20 dB. You can turn on attenuation for individual frequencies and channels or for entire sites. If you turn on attenuation for a site, all frequencies within that site will be attenuated.

Set Step

Select the number of kHz between each channel. Choose *5.0, 6.25, 7.5, 8.33, 10.0, 12.5, 15.0, 20.0, 25.0, 50.0* or *100.0 kHz*. Select *Auto* to use the default step for this band.

Set C-Ch Only

If you activate this feature, you can monitor this system by programming only the control channel (instead of programming the control channel and all the voice channels).

When you use C-Ch Only, you will not be able to use the Trunking Channel Activity Indicators, but you will save memory.

Set MOT BandPlan?

If this custom search is a Motorola system, you need to select a band plan, just like you do when you program a Motorola system for scanning. See [Edit Band Plan](#) for more information.

Search with Scan

Search and Store

Search a stored system and save the frequency information of any active channels.

Set Search Key

The scanner has three one-touch search keys (number keys **1** , **2** , and **3**) that you can assign to any saved search range.

1. Select the search key you want to program (*Search Key 1* through *Search Key 3*).
2. Select the search range you want to assign to this key. The search range can be a service search, a custom search, a tone-out search, or a band scope search.
3. Press **YES** to confirm the selection.

Once you assign a search range to a key, you can start the search just by pressing and

holding the appropriate key.

[Main menu](#)

This page applies to the following scanner(s): [BC346XT Users Guide](#)

BC346XT Settings

- [Set Backlight](#)
 - [Set Mode](#)
 - [Set Dimmer](#)
- [Adjust Key Beep](#)
- [Battery Option](#)
 - [Set Battery Save](#)
 - [Set Charge Time](#)
- [Adjust Contrast](#)
- [Set C-CH Output](#)
- [Set GPS Format](#)
 - [Set POS Format](#)
 - [Set Time Format](#)
 - [Set Time Zone](#)
 - [Set Unit](#)
- [Set Serial Port](#)
- [Band Defaults](#)
 - [Set Modulation](#)
 - [Set Step](#)
- [See Scanner Info](#)
 - [% Memory Used](#)
 - [Firmware Version](#)

Set Backlight

This menu lets you configure the display and key backlight.

Set Mode

Choose how you want the backlight to operate:

10 sec	The scanner keeps the backlight on for 10 seconds after the last operation.
--------	---

30 sec	The scanner keeps the backlight on for 30 seconds after the last operation.
Squelch	The scanner turns on the backlight when a signal breaks squelch.
Keypress	The scanner turns on the backlight when you press a key.
Infinite	The scanner leaves the backlight on all the time.

Set Dimmer

Select the brightness of the backlight. Your options are high (brightest), middle, and low (dimpest).

Adjust Key Beep

Select the volume level (Level 1 through Level 15) you want the keybeep to use, or select *Auto* to have the scanner sound the keybeep without changing the volume. If you don't want the scanner to beep when you press the keys, select *Off*.

Battery Option

This menu lets you configure the advanced battery control features:

Set Battery Save

Turn the battery save feature on or off.

Set Charge Time

Enter the amount of time you want the battery to draw power while charging.

Adjust Contrast

Select one of the 15 available contrast levels for the display. As you scroll through the options, the display adjusts to the highlighted contrast level; press **YES** when you see the display contrast you want to use.

Set C-CH Output

Choose how you want the scanner to handle control channel data:

- *Off* : The scanner will not output the control channel data.
- *On* : The scanner will output the control channel data.
- *Extend* : The scanner will output the control channel data along with any description.

Set GPS Format

Configure how the scanner displays position coordinates, time, and units during GPS operation:

Set POS Format

Select how the scanner displays longitude and latitude:

- *DMS: DDD° MM' SS.ss* : Display coordinates in degrees (DDD), minutes (MM), and seconds (SS.ss).
- *DEG: DDD.ddddd* : Display coordinates as decimal degrees.

Set Time Format

Select 12H for 12-hour (am/pm) time format or 24H for 24-hour time format.

Set Time Zone

Set the number of hours your local time zone differs from universal time (GMT/UTC). Select from -14 hours to +14 hours in half-hour (0.5 h) increments.

Set Unit

Select the unit used for distance: mile or kilometer (km).

Set Serial Port

Set the baud rate for the scanner's serial port. Choose from 4800, 9600, 19200, 38400, 57600 , or 115200 bps; select *Off* to disable the serial port.

Band Defaults

Use this menu to change the default modulation and frequency step or spacing used for each band. The scanner displays the list of available bands in the following format:

{Frequency} : {modulation type} / {step}

Select the frequency band you want to edit. The scanner prompts you for the following information:

Set Modulation

Select the type of modulation you want the scanner to use as the default for this band: AM, Narrowband FM (NFM), FM, Wideband FM (WFM), or FM broadcast (FMB).

Set Step

Select the number of kHz between each frequency or channel step: 5.0, 6.25, 7.5, 8.33, 10.0, 12.5, 15.0, 20.0, 25.0, 50.0, or 100.0 kHz.

See Scanner Info

This menu lets you see detailed information about the memory and firmware.

% Memory Used

See the percent of overall memory used (*Memory Used*) along with the number of programmed *Systems*, *Sites* , and channels (*CHN*) and the percent of available memory positions used for each.

Firmware Version

See the firmware version (*Version*) and the serial number (*SN*) of the scanner.

This page applies to the following scanner(s): [BC346XT Users Guide](#)

```
<!--  
zjq  
-->
```

BC346XT Srch/CloCall Opt

To determine whether the information on this page applies to your scanner, see the tags at the bottom of the page.

This menu lets you set general options for how the scanner operates in Search and Close Call modes.

- [Freq Lockouts](#)
- [Broadcast Screen](#)
 - [Set All Band On](#)
 - [Set All Band Off](#)
 - [Set Each Band](#)
 - [Program Band](#)
- [CTCSS/DCS Search](#)
- [Repeater Find](#)
- [Max Auto Store](#)
- [Set Delay Time](#)
- [Set Attenuator](#)

Freq Lockouts

- *Rvw Search L/O* : This option displays a list of all locked out frequencies. To unlock any frequency on the list, just select it and press **YES** .
- *Unlock All* : This option removes the locks on all frequencies at once.

Broadcast Screen

Choose whether you want the scanner to screen out common broadcast bands and ignore hits on these bands. You can screen out signals on 5 preset bands and up to 10 custom bands. The preset bands are:

- *Pager*
- *FM* (88.1000 - 107.9000 MHz)

- *UHF TV* (470.0000 - 512.0000 MHz)
- *VHF TV* (54.0000 - 72.0000, 76.0000 - 88.0000, and 174.0000 - 216.0000 MHz)
- *NOAA WX* (161.6500, 161.7750, 162.4000, 162.4250, 162.4500, 162.4750, 162.5000, 162.5250, 162.5500, and 163.2750 MHz)

Your options for broadcast screening are listed below:

Set All Band On

Turn on screening for all broadcast bands and ignore any hits on these frequencies.

Set All Band Off

Turn off screening for all broadcast bands, and treat hits on these frequencies the same as any other band.

Set Each Band

Turn screening on or off for each band individually. The scanner displays the bands listed above. Select the band you want to change, then press **YES** to toggle the setting.

Program Band

Create up to 10 custom bands that you want the scanner to screen out hits on.

1. Select a custom band slot (Band 1 through Band 10).
2. When the scanner prompts you, input the lower frequency limit.
3. When the scanner prompts you, input the upper frequency limit.
4. Once you create the custom band, turn screening on or off the same way you did for the preset bands.

CTCSS/DCS Search

Turn this feature on if you want the scanner to search an active frequency for CTCSS/DCS tones. (The scanner ignores this setting in AM, WFM, and FMB bands.)

Repeater Find

If you turn this feature on, whenever the scanner detects a signal on a common repeater input frequency, it automatically searches for that signal on the output frequency. If it finds the signal on the output frequency, the scanner displays *Repeater Found* and switches to monitor the output frequency.

Max Auto Store

Enter the maximum number of hits you want the scanner to store during Search and Store mode or Close Call Auto Store mode. When the number of stored hits reaches the number you enter here, the scanner stops storing hits. Enter a number from *1* to *256* .

Set Delay Time

Set the number of seconds the scanner should wait after a transmission stops before moving on to the next channel. Select *0*, *1*, *2* (default), *5*, *10*, or *30 seconds*.

To have scanner leave the channel after a designated number of seconds whether the transmission stops or not, select one of the negative values. Choose *-10* seconds to have the scanner leave the channel after 10 seconds even if the transmission is still going on; choose *-5 seconds* or *-2 seconds* to have the scanner leave after 5 seconds or 2 seconds, respectively.

Set Attenuator

Turn on attenuation to reduce the signal strength by 20 dB. You can turn on attenuation for individual frequencies and channels or for entire sites. If you turn on attenuation for a site, all frequencies within that site will be attenuated.

This page applies to the following scanner(s): [BC346XT Users Guide](#)

Results from UnidenManBeta web retrieved at 20:07 (GMT)

[AdminMap](#)

[PaulOpitz](#)

r3 - [01 Apr 2009 - 19:23](#)

[BC246TFirmwareUpdate](#)

[PaulOpitz](#)

r6 - [10 Feb 2009 - 21:39](#)

[BC246TUpdate260ReleaseNotes](#)

[PaulOpitz](#)

r2 - [24 Mar 2009 - 15:16](#)

[BC296DFirmwareUpdate](#)

[PaulOpitz](#)

r5 - [12 Feb 2009 - 22:21](#)

[BC296DRebandUpdateBetaComments](#)

[PaulOpitz](#)

r18 - [24 Mar 2009 - 15:17](#)

[BC346XTFirmwareUpdate](#)

[PaulOpitz](#)

r2 - [18 Feb 2009 - 16:14](#)

[BC346XTFirmwareUpdateBetaComments](#)

[DavidMcCormick](#)

r14 - [14 Mar 2009 - 17:56](#)

[BC796DFirmwareUpdate](#)

[PaulOpitz](#)

r5 - [12 Feb 2009 - 22:28](#)

[BC796DRebandUpdateBetaComments](#)

[PaulOpitz](#)

r17 - [24 Mar 2009 - 16:27](#)

[BC898TFirmwareUpdate](#)

[PaulOpitz](#)

r8 - [09 Feb 2009 - 12:17](#)

[BC898TRebandingUpdate](#)

[PaulOpitz](#)

r2 - [24 Mar 2009 - 16:28](#)

[BCD396T301Update](#)

[PaulOpitz](#)

r2 - [24 Mar 2009 - 16:28](#)

[BCD396TFirmwareUpdate](#)

[PaulOpitz](#)

r11 - [16 Feb 2009 - 02:51](#)

[BCD396TICallBetaComments](#)

[PaulOpitz](#)

r11 - [24 Mar 2009 - 16:29](#)

[BCD996T301Update](#)

[PaulOpitz](#)

r4 - [24 Mar 2009 - 16:36](#)

[BCD996TFirmwareUpdate](#)

[PaulOpitz](#)

r10 - [14 Feb 2009 - 21:48](#)

[BCD996TICallBetaComments](#)

[PaulOpitz](#)

r12 - [24 Mar 2009 - 16:35](#)

[BCD996XTFeatures](#)

[PaulOpitz](#)

r2 - [14 Apr 2009 - 18:23](#)

[BCT15FirmwareUpdate](#)

[PaulOpitz](#)

r5 - [10 Feb 2009 - 16:49](#)

[BCT15Update106ReleaseNotes](#)

[PaulOpitz](#)

r2 - [24 Mar 2009 - 16:36](#)

[BCT15X](#)

[PaulOpitz](#)

r2 - [01 Apr 2009 - 19:16](#)

[BCT15XBandScopeMode](#)

[PaulOpitz](#)

r2 - [01 Apr 2009 - 17:21](#)

[BCT15XCloseCallMode](#)

[PaulOpitz](#)

r2 - [01 Apr 2009 - 17:23](#)

[BCT15XGPSMode](#)

[PaulOpitz](#)

r2 - [01 Apr 2009 - 17:25](#)

[BCT15XHoldMode](#)

[PaulOpitz](#)

r2 - [01 Apr 2009 - 17:43](#)

[BCT15XPriorityScan](#)

[PaulOpitz](#)

r2 - [01 Apr 2009 - 17:53](#)

[BCT15XScanMode](#)

[PaulOpitz](#)

r2 - [01 Apr 2009 - 18:31](#)

[BCT15XToneOutMode](#)

[PaulOpitz](#)

r2 - [01 Apr 2009 - 18:38](#)

[BCT8FirmwareUpdate](#)

[PaulOpitz](#)

r8 - [09 Feb 2009 - 12:17](#)

[BCT8RebandingUpdate](#)

[PaulOpitz](#)

r2 - [24 Mar 2009 - 16:36](#)

[BR330T106UpdateBetaComments](#)

[PaulOpitz](#)

r36 - [24 Mar 2009 - 16:37](#)

[BR330TFirmwareUpdate](#)

[DavidMcCormick](#)

r7 - [24 Mar 2009 - 19:15](#)

[Errata](#)

[GastonMascarenas](#)

r4 - [15 Apr 2009 - 01:15](#)

[Erratta](#)

[PaulOpitz](#)

NEW - [26 Mar 2009 - 22:10](#)

[PartsRequest](#)

[PaulOpitz](#)

r6 - [24 Mar 2009 - 20:23](#)

[PublishWeb](#)

[PaulOpitz](#)

r10 - [16 Apr 2009 - 16:24](#)

[RebandVolunteers](#)

[PaulOpitz](#)

r47 - [24 Mar 2009 - 20:49](#)

[ScannerFinder](#)

[PaulOpitz](#)

r2 - [24 Mar 2009 - 20:50](#)

ScannerManuals

PaulOpitz

r22 - 24 Mar 2009 - 20:53

SiteExport

PaulOpitz

r5 - 16 Apr 2009 - 17:45

UnfinishedPages

PaulOpitz

r2 - 24 Mar 2009 - 15:40

Number of topics: 41

NEED TO ADD

NEED TO ADD

NEED TO ADD

NEED TO ADD

NEED TO ADD

NEED TO ADD

Assign a number to this system or channel that you can use to tune directly to a specific channel. Choose a number from 0 to 999. (For more information, see [Number Tags](#).)

Assign this system or site to a Quick Key so you can easily enable or disable it during scanning. Enter a number from 0 to 99; tap NO (the decimal point) if you don't want to assign this system or site to a Quick Key. (For more information, see [Quick Keys](#).)

Assign this group to a Quick Key so you can easily enable or disable it during scanning. Enter a number from 0 to 9; tap NO (the decimal point) if you don't want to assign this group to a Quick Key. (For more information, see [Quick Keys](#).)

This menu lets you configure whether the scanner triggers an alert tone and light whenever this channel or frequency becomes active. (Compare this to the system setting [Emergency Alert](#), which triggers a tone and light when a Talk Group contains an emergency flag.) The available options for [Set Alert Tone](#) and [Set Alert Light](#) are common to both types of alerts.

Monocolor backlights

The following scanners have only one backlight color

- [BC346XT](#)
- [BCT15X](#)

For these scanners, decide whether it triggers a light when the alert condition occurs. Choose the flash pattern (steady *On*, *Slow Blink*, or *Fast Blink*) you want the scanner to use for the alert light. Leave this option at *Off* if you don't want the scanner to flash an alert light.

Multicolor backlights

The following scanners have 7 different backlight colors (blue, red, magenta, green, cyan, yellow, or white)

- [BCD396XT](#)
- [BCD996XT](#)

For these scanners, choose one of backlight colors for the scanner to use for the alert light. Leave this option at *Off* if you don't want the scanner to flash an alert light.

If you select a light color, the scanner prompts you to select the flash pattern (steady *On*, *Slow Blink*, or *Fast Blink*) you want to the alert light to use.

On channels that contain a mix of analog and digital signals (i.e., where the *Audio Mode* is set to *All*), it is possible to have *false decode* problems caused by digital noise at the beginning of transmissions. To prevent this, a user-configurable P25 wait time (from 0 to 1000 ms) has been added.

During the wait time, the scanner evaluates the received signal; if it detects P25 data, the scanner opens squelch immediately. If it does not detect any P25 data, the scanner opens squelch as soon as the wait time expires.

Note: Any analog transmissions on this channel will lose the first part of the transmission, up to the wait time you set here.

Select the number of milliseconds (after the start of a transmission) the scanner should wait while checking for P25 data. Choose a number from 0 through 1000 ms in 100 ms increments. The scanner only applies the wait time setting to Conventional or Motorola (non P25) systems, and only when the channel's *Audio Mode* setting is *All*.

Decide whether you want to lock out a system, site, or channel so the scanner will ignore it during Scan and Search modes. If you lock out a system or site, all channels within that system or site will be locked out. Choose one of the following options:

- *Unlocked*: The system, site, or channel is not locked out.
- *Temporary L/O*: The system, site or channel is locked out until you turn the scanner off and back on.
- *Lockout*: The system, site, or channel is permanently locked out.

CEA Specific Area Message Encoding (SAME) Event Codes

Received Code	Event Name	Event Level	Short Name (Scanner Display)
ADR	Administrative Message	Advisory	Admin Message
AVA	Avalanche Watch	Watch	Avalanche
AVW	Avalanche Warning	Warning	Avalanche
BHW	Biological Hazard Warning	Warning	Biological
BWW	Boil Water Warning	Warning	Boil Water
BZW	Blizzard Warning	Warning	Blizzard
CAE	Child Abduction Emergency	Advisory	Child Emergency
CDW	Civil Danger Warning	Warning	Civil Danger
CEM	Civil Emergency Message	Warning	Civil Emergency
CFA	Coastal Flood Watch	Watch	Coastal Flood
CFW	Coastal Flood Warning	Warning	Coastal Flood
CHW	Chemical Hazard Warning	Warning	Chemical Hazard
CWW	Contaminated Water Warning	Warning	Contam. Water
DBA	Dam Watch	Watch	Dam Break
DBW	Dam Break Warning	Warning	Dam Break
DEW	Contagious Disease Warning	Warning	Contagious
DMO	Practice/demo	Advisory	System Demo
DSW	Dust Storm Warning	Warning	Dust Storm
EAN	Emergency Action Notification	Warning	EMG Notify
EAT	Emergency Action Termination	Advisory	EMG End
EQW	Earthquake Warning	Warning	Earthquake
EVA	Evacuation Watch	Watch	Evacuate Note
EVI	Immediate Evacuation	Warning	Evacuate Note
FCW	Food Contamination Warning	Warning	Food
FFA	Flash Flood Watch	Watch	Flash Flood
FFS	Flash Flood Statement	Advisory	Flash Flood
FFW	Flash Flood Warning	Warning	Flash Flood
FLA	Flood Watch	Watch	Flood
FLS	Flood Statement	Advisory	Flood
FLW	Flood Warning	Warning	Flood
FRW	Fire Warning	Warning	Fire
FSW	Flash Freeze Warning	Warning	Flash Freeze
FZW	Freeze Warning	Warning	Freeze
HLS	Hurricane Statement	Advisory	Hurricane
HMW	Hazardous Material Warning	Warning	Hazardous
HUW	Hurricane Watch	Watch	Hurricane
HWA	High Wind Watch	Watch	High Wind
HWW	High Wind Warning	Warning	High Wind
IBW	Iceberg Warning	Warning	Iceberg
IFW	Industrial Fire Warning	Warning	Industrial Fire

Received Code	Event Name	Event Level	Short Name (Scanner Display)
LAE	Local Area Emergency	Advisory	Local EMG
LEW	Law Enforcement Warning	Warning	Law Enforcement
LSW	Land Slide Warning	Warning	Land Slide
NAT	National Audible Test	Advisory	National Audible
NIC	National Information Center	Advisory	National Info
NMN	Network Notification Message	Advisory	Network Message
NPT	National Periodic Test	Advisory	Nation Periodic
NST	National Silent Test	Advisory	Nation Silent
NUW	Nuclear Power Plant Warning	Warning	Nuclear Plant
POS	Power Outage Advisory	Advisory	Power Outage
RHW	Radiological Hazard	Warning	Radiological
RMT	Required Monthly Test	Advisory	Monthly
RWT	Required Weekly Test	Advisory	Weekly
SMW	Special Marine Warning	Warning	Special Marine
SPS	Special Weather Statement	Advisory	Special WX
SPW	Shelter In-place Warning	Warning	Shelter
SVA	Severe Thunderstorm Watch	Watch	Thunderstorm
SVR	Severe Thunderstorm Warning	Warning	Thunderstorm
SVS	Severe Weather Statement	Advisory	Severe WX
TOA	Tornado Watch	Watch	Tornado
TOE	911 Telephone Outage Emergency	Advisory	911 Phone Outage
TOR	Tornado Warning	Warning	Tornado
TRA	Tropical Storm Watch	Watch	Tropic Storm
TRW	Tropical Storm Warning	Warning	Tropic Storm
TSA	Tsunami Watch	Watch	Tsunami
TSW	Tsunami Warning	Warning	Tsunami
TXB	Transmitter Backup On	Advisory	TX Backup On
TXF	Transmitter Carrier Off	Advisory	TX Carrier Off
TXO	Transmitter Carrier On	Advisory	TX Carrier On
TXP	Transmitter Primary On	Advisory	TX Primary On
VOW	Volcano Warning	Warning	Volcano
WFA	Wild Fire Watch	Watch	Wild Fire
WFW	Wild Fire Warning	Warning	Wild Fire
WSA	Winter Storm Watch	Watch	Winter Storm
WSW	Winter Storm Warning	Warning	Winter Storm
* * A	Unrecognized Watch	Watch	Unrecognized
* * E	Unrecognized Emergency	Advisory	Unrecognized
* * S	Unrecognized Statement	Advisory	Unrecognized
* * W	Unrecognized Warning	Warning	Unrecognized

Assign this system or site to a Startup Key so you can lock or unlock it during power up. Enter a number from 0 to 9; tap NO (the decimal point) if you don't want to assign this system or site to a Startup Key. (For more information, see [Startup Keys](#).)

NEED TO ADD